

High Resolution Site Characterization for Groundwater Short Course

Joshua Barber, EPA Region 3
Steve Dymont, EPA OSRTI
Seth Pitkin, Stone Environmental

23rd Annual NARPM Training Program



EPA United States
Environmental Protection
Agency

Objectives of the Course

- ◆ After taking this course, participants will be able to:
 - Identify high resolution site characterization (HRSC) tools and approaches
 - Describe the technical basis for HRSC
 - Explain the benefits of HRSC
 - Describe the strategies for planning and implementing HRSC

Course Overview

- ◆ Module 1: Introduction and HRSC Overview
- ◆ Module 2: Impacts of Subsurface Heterogeneity
- ◆ Module 3: Potentially Applicable Tools
- ◆ Module 4: HRSC Planning and Implementation
- ◆ Module 5: Wrap Up

Instructor Introductions

- ◆ Joshua Barber, U.S. Environmental Protection Agency Region 3
 - B.A. in Geography, University of South Carolina
 - 12 years with EPA
 - 4 years with EPA HQ Federal Facility Restoration and Reuse Office
 - 8 years with EPA Region 3 Remedial Project Manager
- ◆ Steve Dymant, U.S. Environmental Protection Agency
 - B.S. Environmental Science/Toxicology, University of Massachusetts
 - 20+ years in environmental remediation
 - 4 years commercial CLP laboratory
 - 10 years consulting
 - With EPA OSRTI's Technology Innovation and Field Services Division since 2005
 - Focus on site characterization, CSMs, innovative analytical tools and sampling strategies
- ◆ Seth Pitkin, Stone Environmental, Inc.
 - B.S., Geology
 - MS Hydrogeology, University of Waterloo
 - Studied under and continues to collaborate with John Cherry and his research team
 - Focus on better techniques and tools to understand and remediate organic chemicals in the subsurface

Participant Survey – By a Show of Hands

- ◆ How many of you
 - Work on sites where groundwater is a medium of concern?
 - Work on groundwater sites in the early phase of the process, such as planning for or in the RI/FS?
 - Work on sites that relied on monitoring wells to characterize groundwater contamination?
 - Are having trouble coming to completion with groundwater remedies?
- ◆ How many of you are
 - EPA RPMs?
 - State RPMs?
 - Site managers from other Federal Agencies?
 - Hydrogeologists?

OVERVIEW OF HRSC



23rd Annual NARPM Training Program

1-6

What Type of Investigation is HRSC?

Subsurface investigation appropriate to the scale of heterogeneities in the subsurface which control contaminant distribution, transport and fate, and that provides degree of detail needed to understand:

- Exposure pathways
- Processes affecting fate of contaminants
- Contaminant mass distribution and flux by phase and by media (mobile and immobile)
- How remedial measures will affect the problem

Notes



- ◆ The definition of HRSC is, by necessity, a functional definition. It depends not only on the objectives of the investigator but on the physical nature of the site as well. There is no single sample size or a standard sample spacing that is appropriate for all sites. Spatial structures for key variables are dependent on the geological environment. In addition, the distribution of contaminant concentrations is dependent on the nature and architecture of the source.

- ◆ HRSC is designed and implemented to be appropriate to the scale of the heterogeneities in the subsurface which control contaminant distribution, transport and fate. These heterogeneities happen at a very small scale that traditional investigations miss.

HRSC Addresses “Scale”

Matches the scale of measurement with the scale of the variability of the property being measured

Notes



- ◆ HRSC strategies and techniques use scale-appropriate measurement and data density to define contaminant distributions in environmental media with greater certainty, supporting faster and more effective site cleanup.

Analogies

- ◆ If you want to measure the length of a 2x4 for a wall stud you do not use the odometer on your car. On the other hand, your 10-ft tape measure will not help you figure out how many miles you drove between Indianapolis and Kokomo.
- ◆ If you want to see a bird across a field you use binoculars, but if you want to see paramecia in pond water you use a microscope. Bird-watching with a microscope does not work.

HRSC Addresses Scale First

If measurements are made at the wrong scale it is very hard to understand that which is being measured no matter how many measurements are made

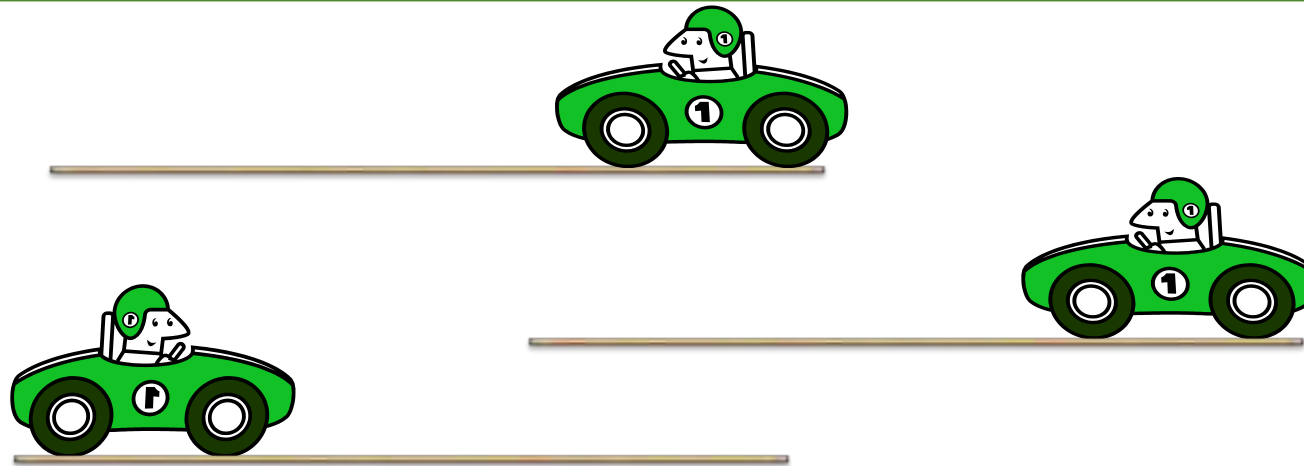

Notes



- ◆ The scale at which measurements are made is a separate (but related) issue from the frequency or spacing or quantity of measurements. If measurements are made at the wrong scale it is very hard to understand that which is being measured no matter how many measurements are made.

HRSC Addresses Measurement Spacing, Density and Placement Second

However, even if measurements are made at the right scale it will not help unless a sufficient number of measurements are made at the right spacing and in the right places



Notes

- ◆ The amount of data is a second issue (scale of measurement being the first). Once the scale to measure at (and what tool to do it with) has been properly determined, the number and placement of measurements can be evaluated.

Even when binoculars are used (instead of a microscope) to look at the cardinal in the tree line, the overall health of the bird population cannot be assessed until many birds are observed in enough trees in enough tree lines. No matter how many times someone looks through the microscope at the birds, nothing will be learned about the birds.

Similarly, measuring one 2x4 with a 10-ft tape measure does not provide any information about the floor plan of the house. For that information, many more measurements would need to be made. However, no matter how many measurements are made with an odometer, nothing about the floor plan would be understood.

Apples and Oranges

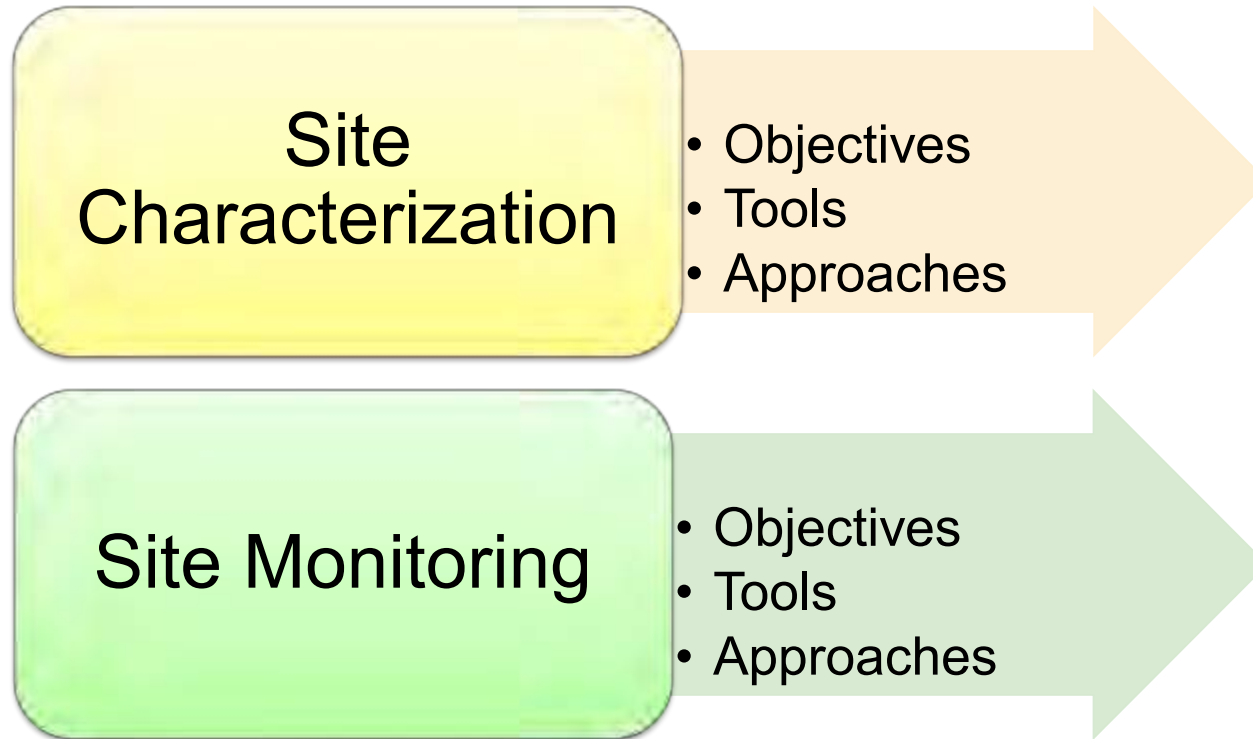

Notes



- ◆ The investigation of sites by installing monitoring wells is done with good intentions. Investigators want to have a data point that they can come back to and collect data from over time. In addition many investigators feel that they are going to have to install monitoring wells anyway for long-term monitoring so they might as well put them in while the investigation is progressing.

How “Well” Do You Understand Your Site Conditions?



- ◆ Technology used influences the understanding you develop
- ◆ The scale of measurement must be appropriate for the scale of the heterogeneity
 - Variability of hydraulic conductivity and other parameters
 - Weak transverse hydrodynamic dispersion
 - Heterogeneous distribution of DNAPL sources
- ◆ Conventional monitoring wells are not optimal investigation tools
 - Wells yield depth-integrated, flow-weighted average data
 - Can not discern small scale heterogeneities controlling contaminant transport in groundwater
- ◆ Monitoring wells have life cycle costs

Notes



- ◆ **Technology used influences the understanding you develop:** Sites investigated using monitoring wells typically have many of the wells in the wrong location and screened over the wrong intervals. The CSM that results from wells that are in the wrong location and screened over the wrong interval does not reflect reality. The construction of wells involves the use of materials that are costly and the installation process is time consuming and expensive. Wells also require maintenance over time. The wells often have to be monitored on a frequent basis for expensive suites of analyses. These costs contribute little to the understanding of the site.
- ◆ **The scale of measurement must be appropriate for the scale of heterogeneity:** Wells do not provide the appropriate scale of measurement for the variability that exists in hydraulic conductivity, contaminant concentrations and other important hydrogeological parameters. Well installation patterns do not take advantage of the fact that there is weak transverse hydrodynamic dispersion. In addition, wells do not provide the appropriate scale of measurement for a site's heterogeneous distribution of DNAPL sources.
- ◆ **Conventional monitoring wells are not optimal investigation tools:** Perhaps the biggest drawback of using monitoring wells as investigation tools is that they typically provide depth-integrated, flow-weighted average data which are not helpful in understanding the spatial structure of the problem. There will be much more on this topic later.
- ◆ **Monitoring wells have life cycle cost:** The cost of a monitoring well is not just the installation cost. Monitoring wells have a life cycle cost which some practitioners estimate to be as much as \$50,000 on average. This includes maintenance and sampling (even when the well is in the wrong place and does not provide particularly useful data).

HRSC Addresses Two Critical Issues

- ◆ Sampling Scale and Data Averaging
 - Measurements must be made at a scale that is meaningful with respect to the variability of the quantity being measured
- ◆ Coverage
 - Enough measurements at the right locations
 - Horizontal spacing
 - Vertical spacing



Notes



- ◆ “High resolution” is achieved by addressing these two key issues: (1) sample scale/data averaging and (2) spacing the samples appropriately in three dimensions. Sample scale and data averaging and coverage are discussed further in Module 2.

Figure 1

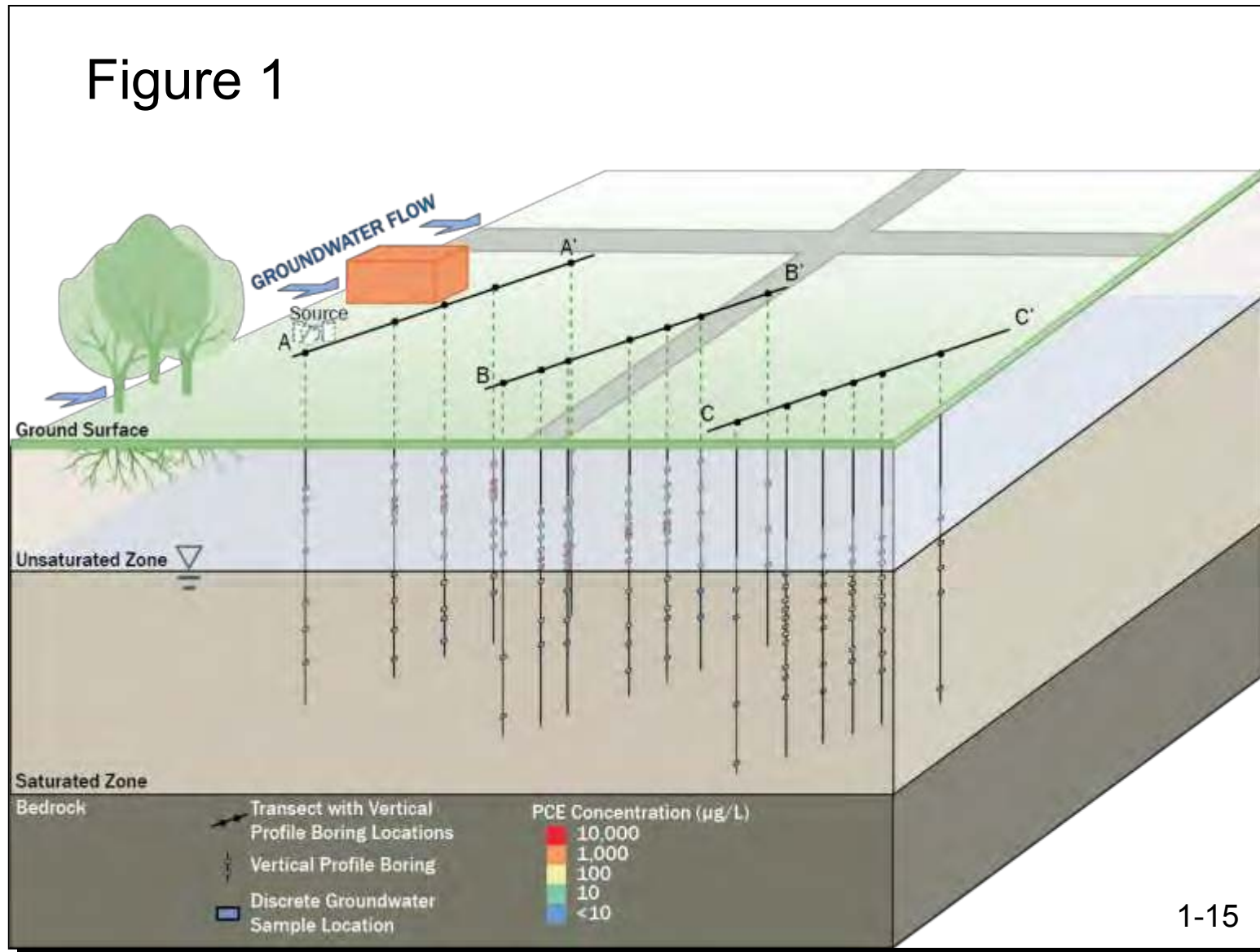

1-15

Notes



- ◆ A primary HRSC strategy for groundwater contamination in unconsolidated aquifers uses transects of vertical subsurface profiles oriented perpendicular to the direction of the hydraulic gradient. Profiles are advanced to depth along each transect and used to collect detailed geologic and hydrogeologic information. These data are then combined with groundwater contaminant data obtained from discrete-interval groundwater sampling to generate 2-dimensional (2-D) cross-sections, or more advanced 3-D visualizations, to identify lower concentration dissolved plumes and higher concentration plume cores correlated with site geology and hydrogeology.
- ◆ Figures 1 through 7 that follow illustrate a hypothetical application of HRSC to investigate perchloroethene (PCE)-contaminated groundwater in an unconsolidated aquifer at a manufacturing facility. A bedrock formation that is not a drinking water concern underlies the unconsolidated aquifer at the site.
- ◆ Figure 1 above shows the location of three transects used to investigate the release of PCE from a suspected source at the facility. Each transect is oriented perpendicular to groundwater flow and consists of vertical profiles advanced to depth in the overburden using direct push technology (DPT). Continuous geologic and hydrogeologic data are collected at a high density over the vertical extent of each profile boring using direct sensing technologies. In addition, a direct sensing tool such as the membrane interface probe (MIP) can be used to evaluate the distribution of contamination between higher hydraulic conductivity (K) and lower K zones. These data are used to target higher K zones for groundwater sample collection using a discrete interval groundwater sampling technology. More information on direct sensing and discrete interval sampling technologies can be found at <http://www.brownfieldstsc.org/roadmap/contByInvTech.cfm>.

Source: www.clu-in.org/characterization/technologies/hrsc/

Figure 2

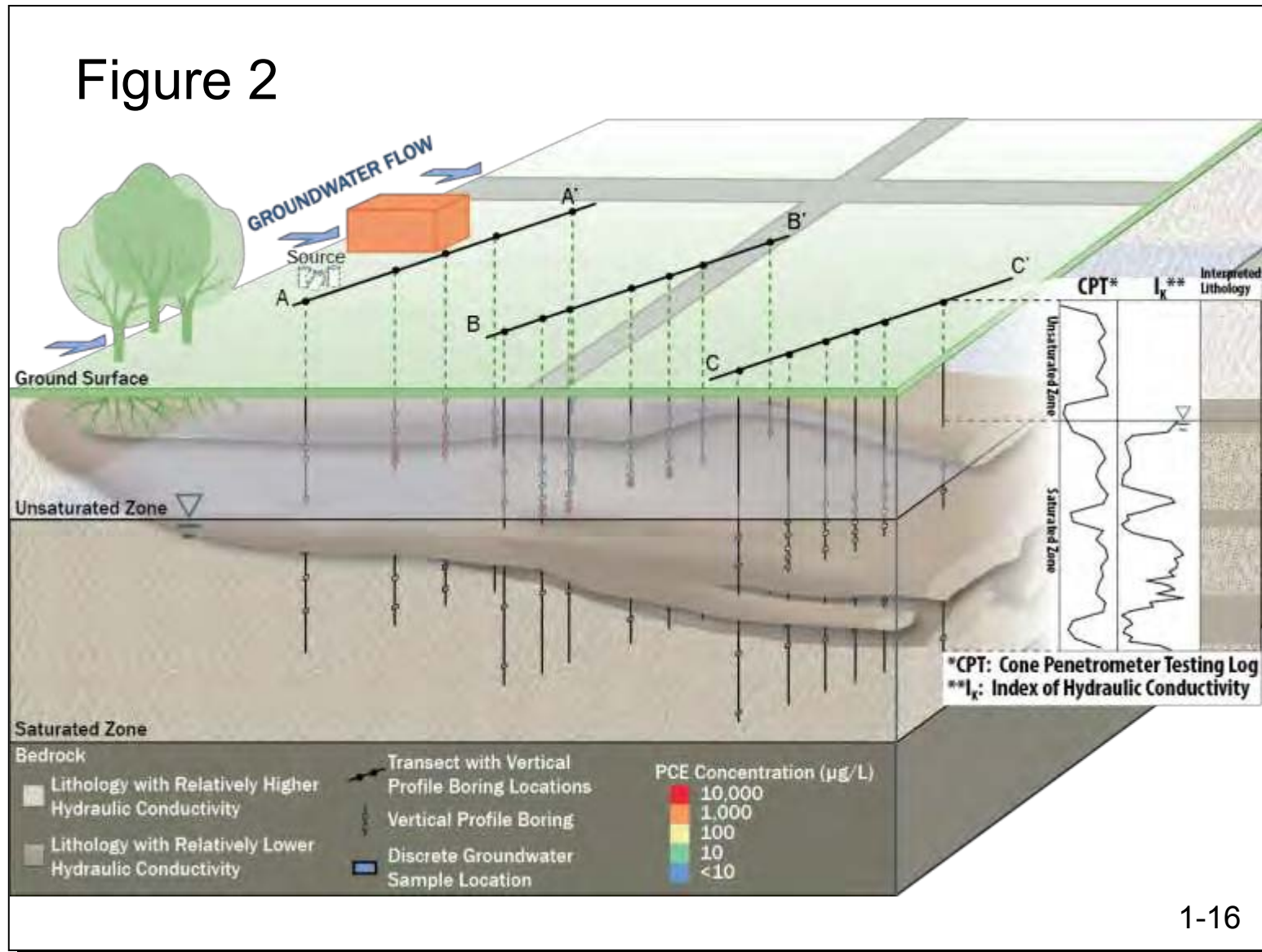

Notes

- ◆ Figure 2 above shows the interpreted unconsolidated and bedrock lithology at the site based on 3-D visualization of the high-density, direct sensing geologic and hydrogeologic data and depth to bedrock information. Vertical data plots, similar to soil boring logs, show the heterogeneous distribution of lithologic zones of relatively high and low K that control contaminant fate and transport. Spatial assessment of other site data can improve site understanding. Other site data could include data from a vertical profiling effort, such as hydraulic head, physiochemical parameters, qualitative (screening) contaminant levels and quantitative contaminant concentrations.

Source: www.clu-in.org/characterization/technologies/hrsc/

Figure 3

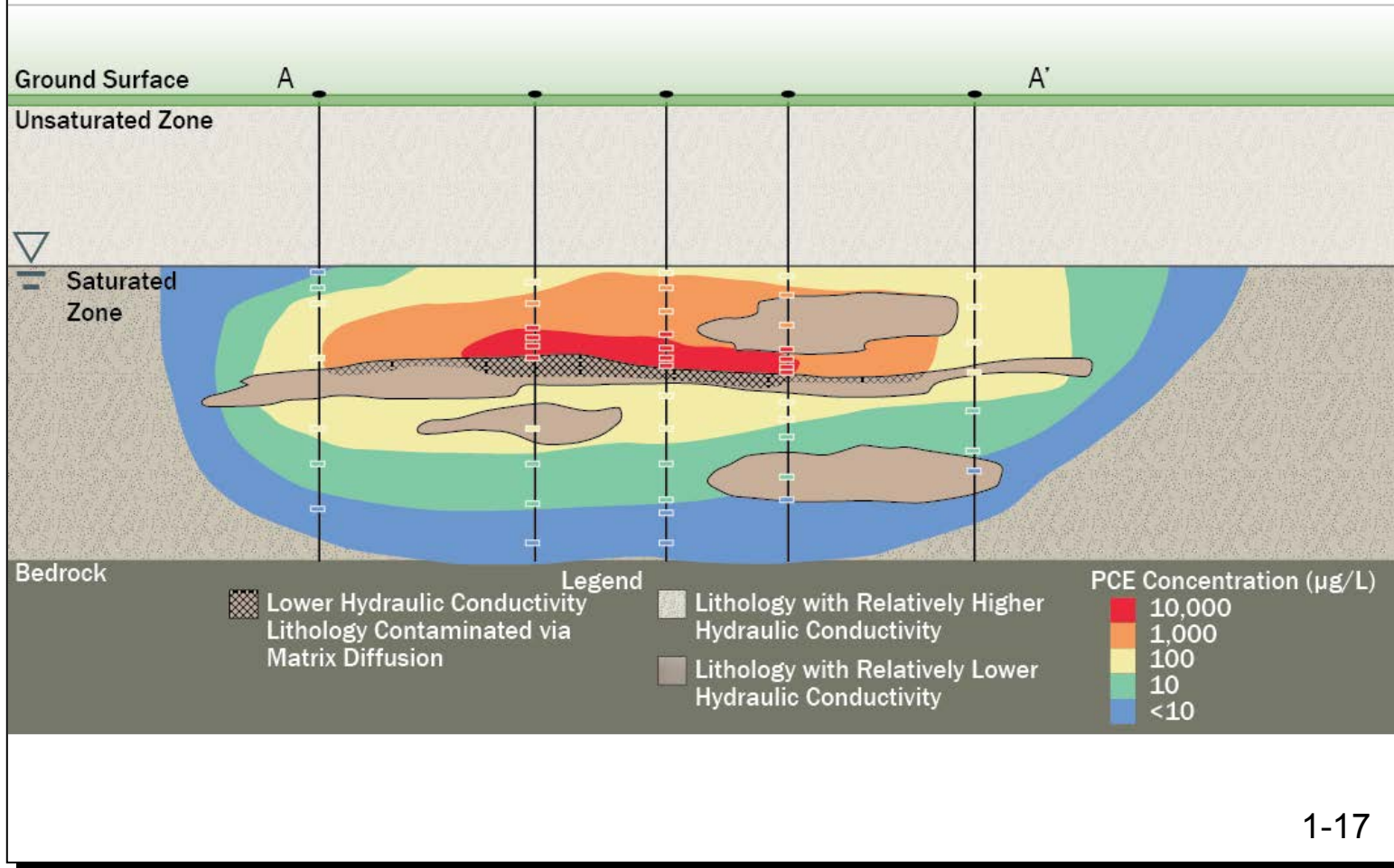

1-17

Notes

- ◆ Figure 3 is a 2-D visualization of the integrated geologic/hydrogeologic and contaminant concentration data for Transect A-A'. Contaminant concentrations detected in groundwater samples collected at discrete vertical intervals indicate a lower concentration plume and a higher concentration, higher mass per unit volume plume core (PCE concentrations exceeding 10,000 micrograms per liter [$\mu\text{g/L}$]), both in dissolved phase. [Note: on many sites, it is common for there to be multiple plume cores. This example assumes one plume core for presentation simplicity. However, the existence of multiple plume cores of various dimensions, positions and contaminant concentrations is a major driver behind the need to characterize sites using HRSC strategies.] The concentration distribution shown on Transect A-A' is consistent with established research which concludes that 75 percent of contaminant mass discharge occurs in only five to 10 percent of the plume cross sectional area (Gilbeault et al. 2005). Concentrations markedly decline away from the plume core over relatively short distances. The plume core is confined to a relatively thin interval of relatively higher K material, indicating that the bulk of the dissolved phase mass is moving through a comparatively small cross section of the aquifer. Potentially significant contaminant mass, however, is also likely stored in the adjacent lower K units through matrix diffusion. The length of time since the contaminant release and the scale of subsurface heterogeneity significantly impact the degree to which matrix diffusion has occurred. At this stage, additional field efforts may be warranted to better characterize the degree of matrix diffusion influence to support remedy selection and design.

Source: www.clu-in.org/characterization/technologies/hrsc/

Figure 4

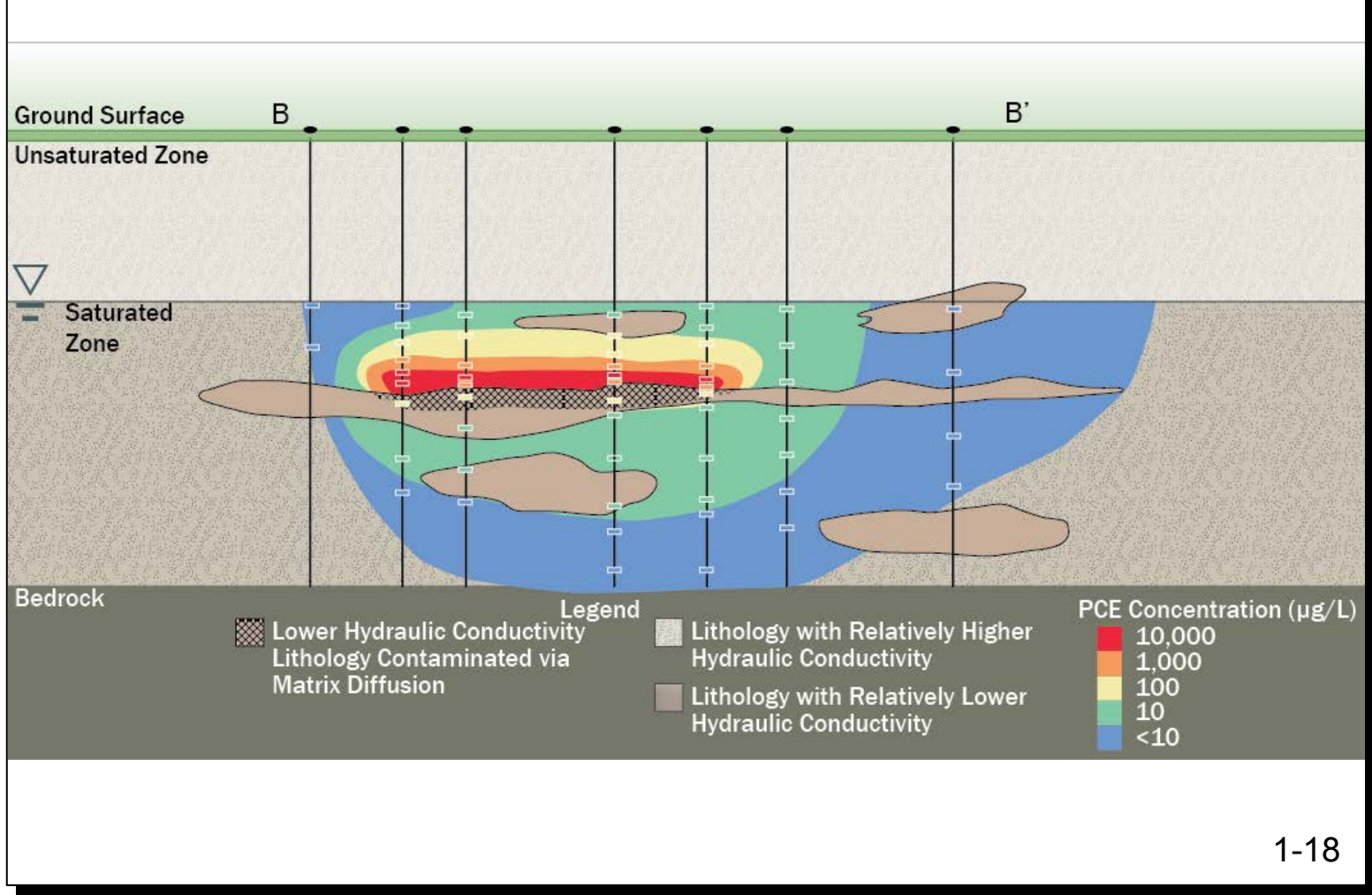

Notes



- ◆ Transect B-B' (Figure 4 above), located downgradient of Transect A-A' and at progressively greater distance from the source area, shows a consistent morphology of a thin plume core present within a larger, lower concentration dissolved plume.

Source: www.clu-in.org/characterization/technologies/hrsc/

Figure 5

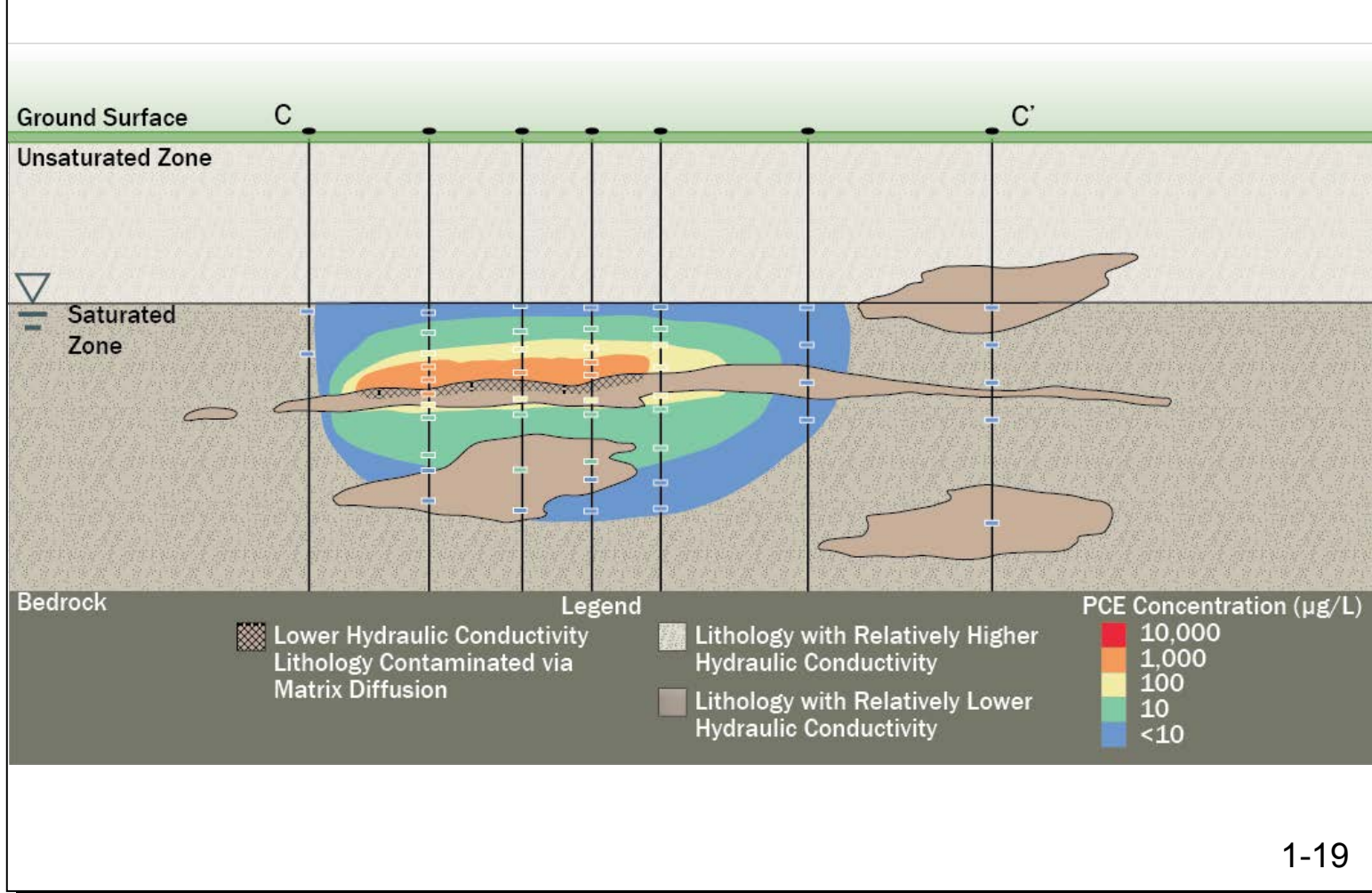

Notes



- ◆ Transect C-C' (Figure 5 above), located downgradient of Transect B-B' and at the distal edge of the plume, shows a consistent plume core and plume morphology, but with significantly lower concentrations present within the plume core.

Source: www.clu-in.org/characterization/technologies/hrsc/

Figure 6

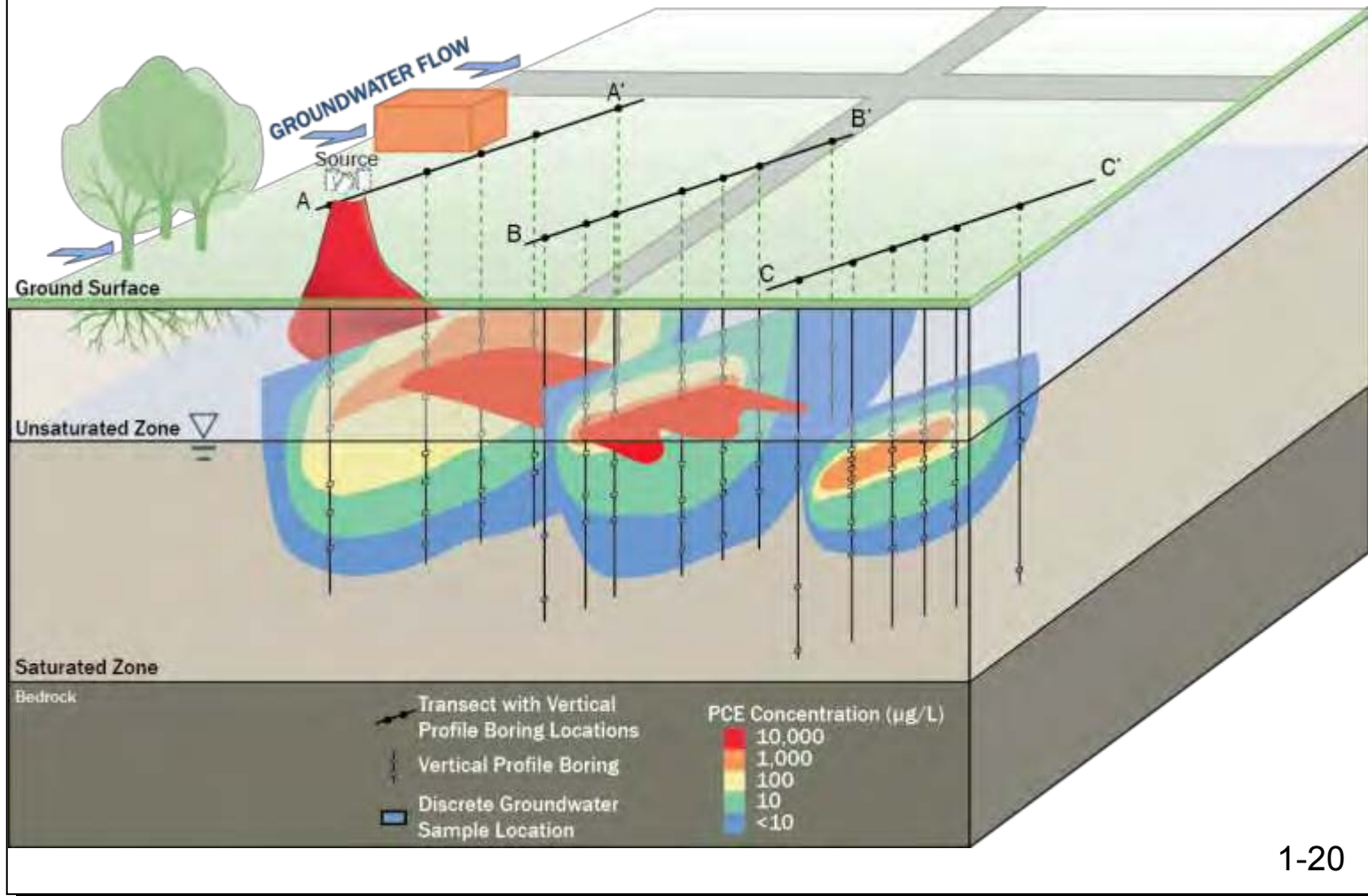

1-20

Notes

- ◆ Figure 6 above presents the three transects oriented in 3-D, showing the plume and plume core with respect to the source area and the prevailing groundwater flow direction. The visualization indicates that use of a HRSC strategy has effectively defined the higher K lithologic zones that serve as preferential pathways for both the dissolved plume and plume core. Similarly, HRSC has defined the lower K lithologic zones which commonly contain the majority of the contaminant mass and can serve as long-term secondary sources for the dissolved plume and plume core. The visualization also demonstrates, how in many instances, the plume information generated using HRSC transects can be used to locate or confirm specific source areas.

- ◆ The subsurface detail provided by HRSC can also support the design of targeted remedial approaches to remove mass from the plume core and low K lithologic zones and control the downgradient migration of the dissolved plume at its distal edge. In this case, HRSC identifies where contaminant mass is located spatially, and clarifies the hydrogeologic context in which the mass resides and behaves. This knowledge lowers site uncertainty and can significantly contribute to the design and success of any remedy or suite of technologies being considered for site cleanup.

Source: www.clu-in.org/characterization/technologies/hrsc/

Figure 7

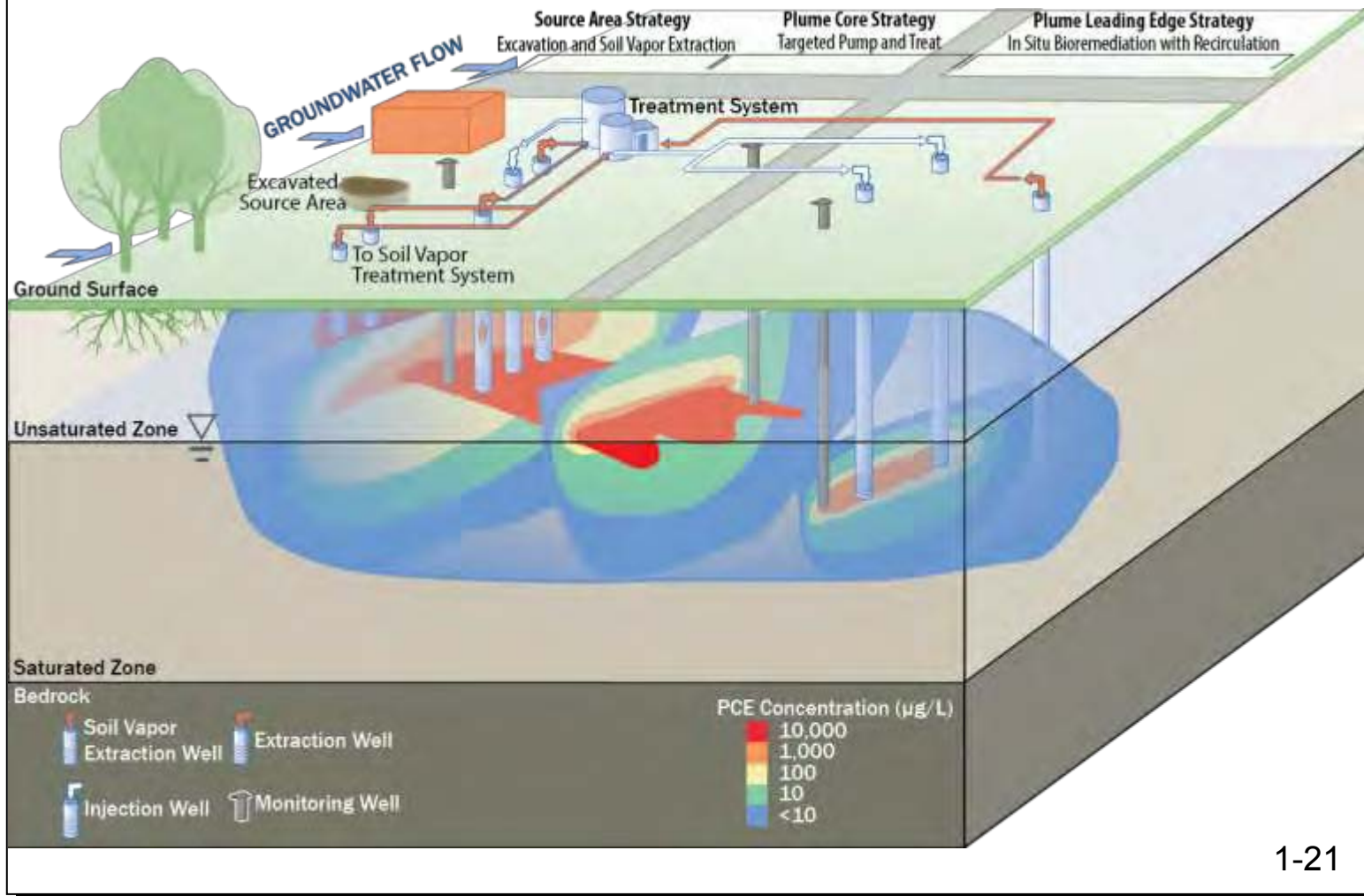

1-21

Notes

- ◆ Figure 7 shows how HRSC data can be leveraged to design a comprehensive site remedial strategy and appropriately target remedial technologies. For the hypothetical site, separate technologies are implemented in an integrated strategy to address the source, plume core and plume leading edge areas. After excavation of source materials, soil vapor extraction (SVE) is used to reduce contaminant mass in source area soils and groundwater. Targeted groundwater pump and treat (P&T) is used to reduce mass in the plume core, with extraction wells designed to be screened only in the plume core rather than penetrating the full plume. This enables more efficient mass removal at lower pumping rates compared to fully penetrating wells. In situ bioremediation with recirculation is applied at the leading edge of the plume to control migration of the lower concentration dissolved plume. Monitoring wells installed at locations targeted using the HRSC data are used to monitor remedy performance, progress and compliance.

Source: www.clu-in.org/characterization/technologies/hrsc/

Transect Approach for Groundwater Contaminant Plumes

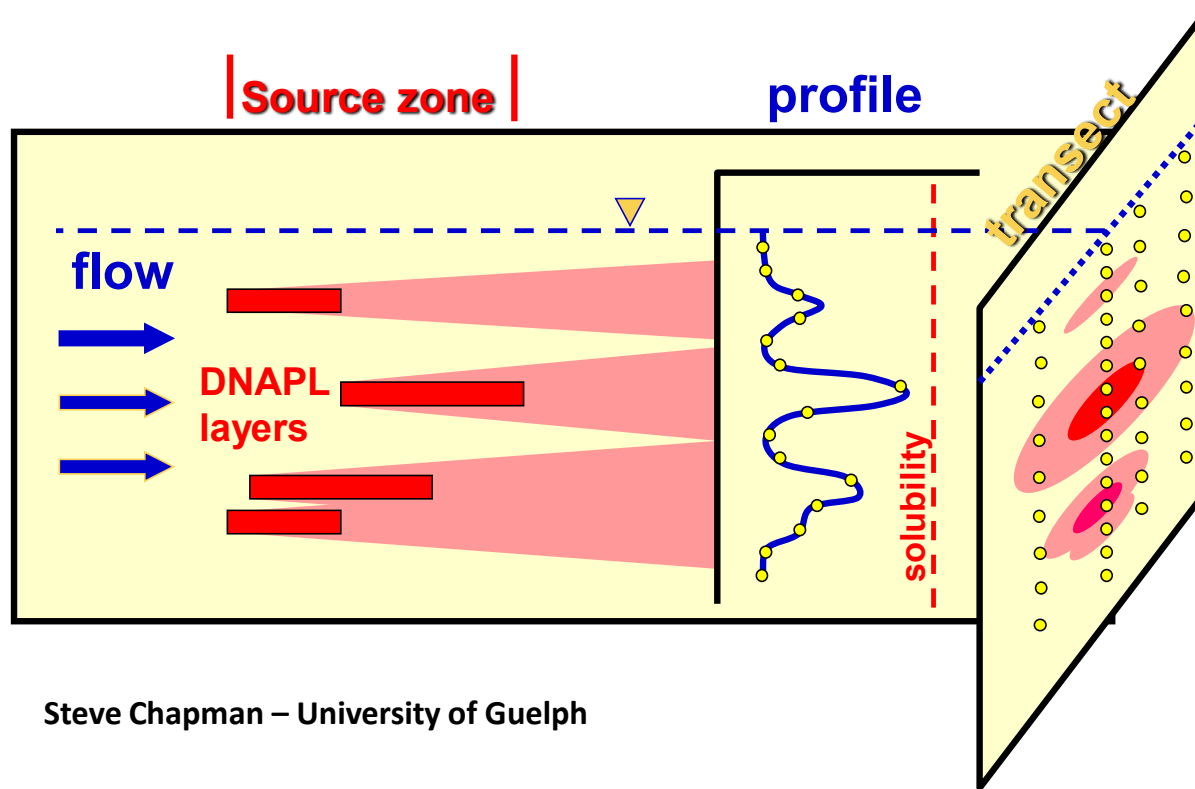

Steve Chapman – University of Guelph

Notes

- ◆ The use of vertical profiles provides excellent information on the vertical distribution of variables at a given location. Organizing these profiles along lines transverse to the direction of transport (or along transects) provides a comprehensive view of the plume anatomy. Such an approach is also well suited to providing a flux-based view of plumes. A transect can be thought of as a movie screen upon which the projector casts an image of the source material located upgradient. Thus when a transect is completed downgradient of the source area people commonly refer to “back projecting” the locations of the source material from the “hot spots” on the transect.

Tools for Obtaining Vertical Profiles in Unconsolidated Environments

- ◆ Soil coring:
 - Direct push - Sonic - Auger and Rotary
- ◆ Direct push groundwater sampling devices:
 - Geoprobe SP16/SP21 - WaterlooAPS - BAT Sampler - Cone Sipper
- ◆ Hydrostratigraphic measurements:
 - EC - Cone penetrometer - Geoprobe Hydraulic Profiling Tool - Waterloo Advanced Profiling System by Stone Environmental
- ◆ Qualitative contaminant data:
 - MIP - LIF - PID - FID - Immunoassay - Colorimetric
- ◆ Quantitative contaminant data:
 - Mobile laboratory - Fixed laboratory

Tools for Fractured Media

- ◆ Rock core measurements
 - Contaminant analysis with microwave assisted extraction – Physical, mineralogical and microbial measurements – Degradation microcosms
- ◆ Open hole measurements, (time during which boreholes are open should be minimized):
 - Groundwater sampling – Geophysics – Packer testing – Flow metering – Temperature
- ◆ Lined hole measurements:
 - Geophysics – Temperature – Hydraulic conductivity profiling – Multi-level sampling

HRSC Tools Matrix

- ◆ Tool/Technology/Approach and Target Data
- ◆ Applicable media
 - Environment
 - Lithology
- ◆ Type of data generated
 - Geologic
 - Hydrogeologic
 - Contaminant
- ◆ Approximate production rate

Tool/Technology/Approach and Target Data	Applicable Media										Type of Data Generated											Approximate Production Rate					
	Environment					Lithology					Geologic Data	Hydrogeologic Parameters			Contaminant Classes												
	Unconsolidated - Shallow (< 120 ft bgs)	Unconsolidated - Deep (> 120 bgs)	Fractured Media	Porous Media	Groundwater-Surface Water Interfaces	Gravel	Sand	Silt	Clay	Glacial Till		Geologic Conditions - Quantitative	Hydraulic Head	Quantitative or relative K	Groundwater flow / flux	NAPL		VOCs			SVOCs		Metals	Explosives			
											DNAPL (chlorinated solvents)					LNAPL	VOCs - Speciation	VOCs - Concentration	VOCs - Vertical Distribution	VOCs - Halogenated	VOCs - Nonhalogenated	SVOCs - Halogenated			SVOCs - Nonhalogenated		
																						Approximate Production Rate - Borehole Advanced (feet/day)	Soil samples/data per day	Groundwater samples/data per day			
Soil Coring <i>Sonic Drilling</i> - Soil characteristics that control NAPL and solute transport (permeability, grain-size, porosity, diffusion tests/tortuosity); contaminant mass distribution (high vs. low K zones); concentration gradients; diffusive fluxes. Samples for microbiological techniques	✓	✓	✓	✓	✓	✓	✓	✓	✓	✓	◇	◇		✓	✓	✓	✓	✓	✓	✓	✓	✓	✓	✓	100-200	50-100	N/A
CPT (Cone Penetrometer Testing) - Direct Push Continuous stratigraphic profile and depth specific hydraulic head data (can be combined with MIP, LIF, TarGOST raman spectroscopy)	✓	◇		✓	✓	✓	✓	✓		✓	✓	✓		✓	✓	✓	✓	✓	✓	✓	✓	✓	✓	400-500	N/A	5-10	
HPT (Hydraulic Profiling Tool) - Direct Push Continuous hydrostratigraphic profile to define contaminant migration pathways; electrical conductivity (can be combined with LIF, MIP)	✓			✓	✓	✓	✓	✓		◇	✓	✓												150	N/A	N/A	
Borehole Flowmeters <i>Impellar, Heat Pulse, Electromagnetic</i> - Vertical flow within borehole. Distribution of K along borehole	✓	✓	✓	✓	✓	✓	✓		✓		✓	✓	✓											N/A	N/A	N/A	
Hydraulic Tomography Continuous 3D distribution of K	✓	✓	✓	✓	✓	✓	✓		✓		✓	✓	✓											N/A	N/A	N/A	
MIP (Membrane Interface Probe) - Direct Push <i>MIP-EC, MiHpt, MIP-HTL, LL MIP, MIP-XSD</i> - Continuous qualitative profile of VOCs and some SVOCs in saturated and vadose zones; EC	✓				◇	✓	✓			◇						◇	✓	◇	◇					150	continuous	N/A	

Tool/Technology/Approach and Target Data	Applicable Media										Type of Data Generated										Approximate Production Rate					
	Environment					Lithology					Geologic Data	Hydrogeologic Parameters			Contaminant Classes											
	Unconsolidated - Shallow (< 120 ft bgs)	Unconsolidated - Deep (> 120 bgs)	Fractured Media	Porous Media	Groundwater-Surface Water Interfaces	Gravel	Sand	Silt	Clay	Glacial Till	Geologic Conditions - Quantitative	Hydraulic Head	Quantitative or relative K	Groundwater flow / flux	NAPL		VOCs			SVOCs		Metals	Explosives			
															DNAPL (chlorinated solvents)	LNAPL	VOCs - Speciation	VOCs - Concentration	VOCs - Vertical Distribution	VOCs - Halogenated	VOCs - Nonhalogenated			SVOCs - Halogenated	SVOCs - Nonhalogenated	
Approximate Production Rate - Borehole Advanced (feet/day)	Soil samples/data per day	Groundwater samples/data per day																								
LIF (Laser Induced Fluorescence) - Direct Push <i>UVOST®, ROST®, TarGOST®, FFD</i> - Continuous qualitative profile of PAHs (light petroleum fuels to coal tars); (detects NAPL, but not dissolved-phase)	✓				◇	✓	✓		◇	◇					✓									200-300	continuous	N/A
Groundwater Sampling - Direct Push <i>Geoprobe SP16/SP21, Solinst Drive Point Piezometers</i> - Contaminant concentrations at short, discrete intervals	✓				◇	◇	✓	✓						✓	✓	✓	✓	✓	✓	✓	✓	✓			N/A	
Geoprobe HPT-GWS - Direct Push <i>Combined HPT, Discrete Groundwater Sampler, EC</i> - Contaminant concentrations at short, discrete intervals; continuous hydrostratigraphic profile to define contaminant migration pathways; EC	✓				✓	✓	✓		◇	✓	✓	✓		✓	✓	✓	✓	✓	✓	✓	✓	✓		150	N/A	20-40
Waterloo Advanced Profiling System™ - Direct Push <i>Can penetrate to ~ 600ft when combined with conventional drilling techniques</i> - Contaminant concentrations at short, discrete intervals; continuous distribution of relative K, hydraulic head, and pH, SC, DO, and ORP	✓	✓			✓	✓	◇	◇	◇	✓	✓	✓		✓	✓	✓	✓	✓	✓	✓	✓	✓		50-100	N/A	5-10
Enhanced Access Penetration System (EAPS) <i>Extends CPT Penetration Depth to >500ft</i> - CPT data, contaminant concentrations	✓	✓			✓	✓	✓	✓	✓	✓	✓	✓		✓	✓	✓	✓	✓	✓	✓	✓	✓		400-500	N/A	5-10
Multi-level Sampling Systems <i>CMT, Westbay, FLUTE, BarCad</i> - Contaminant concentrations at short, discrete intervals; pressure	✓	✓	✓	✓	✓	✓	✓	✓	✓		✓	◇	◇	✓	✓	✓	✓	✓	✓	✓	✓	✓		N/A	N/A	N/A

Tool/Technology/Approach and Target Data	Applicable Media										Type of Data Generated										Approximate Production Rate									
	Environment					Lithology					Geologic Data	Hydrogeologic Parameters			Contaminant Classes															
	Unconsolidated - Shallow (< 120 ft bgs)	Unconsolidated - Deep (> 120 bgs)	Fractured Media	Porous Media	Groundwater-Surface Water Interfaces	Gravel	Sand	Silt	Clay	Glacial Till		Geologic Conditions - Quantitative	Hydraulic Head	Quantitative or relative K	Groundwater flow / flux	NAPL		VOCs			SVOCs		Metals	Explosives						
											DNAPL (chlorinated solvents)					LNAPL	VOCs - Speciation	VOCs - Concentration	VOCs - Vertical Distribution	VOCs - Halogenated	VOCs - Nonhalogenated	SVOCs - Halogenated			SVOCs - Nonhalogenated					
																								Approximate Production Rate - Borehole Advanced (feet/day)	Soil samples/data per day	Groundwater samples/data per day				
Packer Testing Contaminant and hydraulic properties at discrete intervals	✓	✓	✓	✓		✓	✓	✓	✓	✓		✓	✓													N/A	N/A	N/A		
Discrete Fracture Network (DFN) Method Multi-faceted approach; continuous rock core used to obtain high-resolution contaminant distribution, physical properties, etc; borehole used for groundwater sampling, geophysics, packer tests, flow metering, temperature, conductivity (employing flexible, impervious liner at early stage to minimize cross-contamination)	◇	◇	✓	✓				◇	✓	✓	✓	◇	✓	✓	✓	✓	✓	✓	✓	✓	✓	✓	✓	✓	✓			N/A	N/A	N/A
Flow Velocity Sensor Temperature to measure flow direction and velocity in groundwater; allows for precision and accuracy in observing horizontal and vertical flow vectors	✓	✓	✓	✓	✓	✓	✓	✓	✓	✓		✓	✓														N/A	N/A	N/A	
Point Velocity Probes Direction and magnitude of groundwater flow velocity without a well	✓	✓	✓	✓	✓	✓	✓	✓	✓	✓		✓	✓														N/A	N/A	N/A	
Passive Flux Meter <i>Self-contained permeable unit inserted into well</i> Contaminant mass flux; groundwater volumetric flux (including to gaining streams)	✓	✓	✓	✓	✓	✓	✓	✓	✓	✓		✓	✓			✓	✓	✓	✓	✓	✓	✓	✓	✓	✓			N/A	N/A	N/A
Polyethylene Diffusion Bag Samplers VOC concentrations in groundwater or in groundwater discharging to surface water	✓	✓	✓	✓	✓	✓	✓	✓	✓	✓							✓	✓	✓	✓	✓	✓	✓	✓	✓			N/A	N/A	N/A

Tool/Technology/Approach and Target Data	Applicable Media										Type of Data Generated										Approximate Production Rate						
	Environment					Lithology					Geologic Data	Hydrogeologic Parameters			Contaminant Classes												
	Unconsolidated - Shallow (< 120 ft bgs)	Unconsolidated - Deep (> 120 bgs)	Fractured Media	Porous Media	Groundwater-Surface Water Interfaces	Gravel	Sand	Silt	Clay	Glacial Till		Geologic Conditions - Quantitative	Hydraulic Head	Quantitative or relative K	Groundwater flow / flux	NAPL		VOCs			SVOCs		Metals	Explosives			
											DNAPL (chlorinated solvents)					LNAPL	VOCs - Speciation	VOCs - Concentration	VOCs - Vertical Distribution	VOCs - Halogenated	VOCs - Nonhalogenated	SVOCs - Halogenated			SVOCs - Nonhalogenated		
Approximate Production Rate - Borehole Advanced (feet/day)		Soil samples/data per day		Groundwater samples/data per day																							
Mini-Piezometers Identify gaining and losing reaches of streams	✓			✓							✓					✓	✓	✓	✓	✓			N/A	N/A	N/A		
Pushpoint Samplers Contaminant concentrations in sediment pore water	✓			✓												✓	✓		✓	✓	✓			N/A	N/A	N/A	
Streambed Temperature Measurement <i>Thermal Imaging, Distributed temperature sensor</i> - Identify gaining and losing reaches of streams and estimate groundwater flux	✓			✓									✓											N/A	N/A	N/A	
Onsite Laboratory <i>Rapid Laboratory grade GC, GCMS, HPLC, other</i> Contaminant concentrations														✓	✓	✓	✓		✓	✓	✓	✓		✓	N/A	Dependent on analyte types	Dependent on analyte types

ACRONYMS

bgs below ground surface
 CMT Continuous multichannel tubing
 CPT Cone penetrometer testing
 DFN Discrete Fracture Network
 DO dissolved oxygen
 DNAPL dense non-aqueous liquid
 EAPS Enhanced Access Penetration System
 EC electrical conductivity

FFD fuel fluorescence detector
 GC gas chromatograph
 GC/MS gas chromatograph/mass spectrometer
 HPLC high-performance liquid chromatography
 HPT hydraulic profiling tool
 HPT-GWS hydraulic profiling tool-groundwater sampler
 K hydraulic conductivity
 LIF laser-induced fluorescence

LL MIP low level membrane interface probe
 LNAPL light non-aqueous phase liquid
 MiHpt Membrane Interface Probe-Hydraulic Profiling Tool
 MIP membrane interface probe
 MIP-EC membrane interface probe – electrical conductivity
 N/A not applicable

KEY Applicable = ✓
 May be applicable = ◊

Tool/Technology/Approach and Target Data	Applicable Media									
	Environment				Lithology					
	Unconsolidated - Shallow (< 120 ft bgs)	Unconsolidated - Deep (> 120 bgs)	Fractured Media	Porous Media	Groundwater-Surface Water Interfaces	Gravel	Sand	Silt	Clay	Glacial Till
LIF (Laser Induced Fluorescence) - Direct Push UVOST [®] , ROST [®] , TarGOST [®] , FFD - Continuous qualitative profile of PAHs (light petroleum fuels to coal tars); (detects NAPL, but not dissolved-phase)	✓					◊	✓	✓		◊

Applicable
✓
May be applicable
◊

Tool/Technology/Approach and Target Data	Type of Data Generated													
	Geologic Data	Hydrogeologic Parameters			Contaminant Classes									
					NAPL		VOCs			SVOCs		Metals	Explosives	
Geologic Conditions - Quantitative	Hydraulic Head	Quantitative or relative K	Groundwater flow / flux	DNAPL (chlorinated solvents)	LNAPL	VOCs - Speciation	VOCs - Concentration	VOCs - Vertical Distribution	VOCs - Halogenated	VOCs - Nonhalogenated	SVOCs - Halogenated	SVOCs - Nonhalogenated	Metals and metalloids	Explosives and energetics
LIF (Laser Induced Fluorescence) - Direct Push UVOST®, ROST®, TarGOST®, FFD - Continuous qualitative profile of PAHs (light petroleum fuels to coal tars); (detects NAPL, but not dissolved-phase)	◊				✓									

Applicable
✓
May be applicable
◊

Tool/Technology/Approach and Target Data	Approximate Production Rate		
	Approximate Production Rate - Borehole Advanced (feet/day)	Soil samples/data per day	Groundwater samples/data per day
	LIF (Laser Induced Fluorescence) - Direct Push UVOST®, ROST®, TarGOST®, FFD - Continuous qualitative profile of PAHs (light petroleum fuels to coal tars); (detects NAPL, but not dissolved-phase)	200-300	continuous

Applicable
✓
May be applicable
◊

WHY HRSC?



23rd Annual NARPM Training Program

1-29

Increases Remedy Effectiveness

- ◆ HRSC increases remedy effectiveness by providing a detailed and realistic CSM:
 - Correlating contaminant data with stratigraphic and lithologic data
 - Identifying and delineating source zones
 - Identifying contaminant mass flux
 - Identifying plume core and evaluating plume stability
 - Characterizing fate and transport of contaminants in the subsurface
- ◆ A detailed and more realistic CSM allows for evaluation of targeted in situ and ex situ remedies

Notes



- ◆ **HRSC increases remedy effectiveness by providing a detailed and realistic CSM:** For both source and groundwater media, HRSC increases remedy effectiveness by providing a detailed and realistic CSM. For source areas, HRSC can pinpoint the location of the contamination so that the remedy addresses a more refined volume of material for treatment and disposal. For groundwater problems, HRSC provides the following critical information:
 - » Correlation of contaminant data with stratigraphic and lithologic data.
 - » Identification and delineation of source zones.
 - » Identification of contaminant mass flux in both the mobile and immobile porosity.
 - » Identification of plume core and evaluation of plume stability.
 - » Characterization of fate and transport of contaminants in the subsurface.

- ◆ **A detailed and more realistic CSM allows for evaluation of targeted in situ and ex situ remedies:** Most sites require a combination of technologies to address the site contamination. By using HRSC to develop a detailed CSM, various remedial technologies can be combined to target the zones of contamination for which they are best suited.

Cost of Remedies vs. Cost of Characterization

- ◆ Remedies based on a flawed CSM may not perform as expected, increasing the time it takes to achieve remedial action objectives and the overall cost
- ◆ HRSC makes the investment upfront to obtain a more complete and realistic CSM
- ◆ Pay a little more now to avoid paying a lot more later
 - Until the CSM reflects reality, investigation and cleanup will be costly – pay the costs upfront and get the CSM right the first time in order to avoid paying more later

Notes



- ◆ Site managers must balance the need for information with the need to take action. However, remedies based on a flawed CSM are likely to be costly because they do not perform as expected, which usually increases the time it takes to achieve cleanup levels and the overall cost. HRSC strategies and techniques provide a dense data set for the same or less cost than the traditional approach and can be completed in a much faster time frame. HRSC offers the best opportunity for developing a realistic CSM, and in the end, reality will win the day.

Transect Case Study: Secondary Groundwater Plume Characterization, Pease AFB, NH

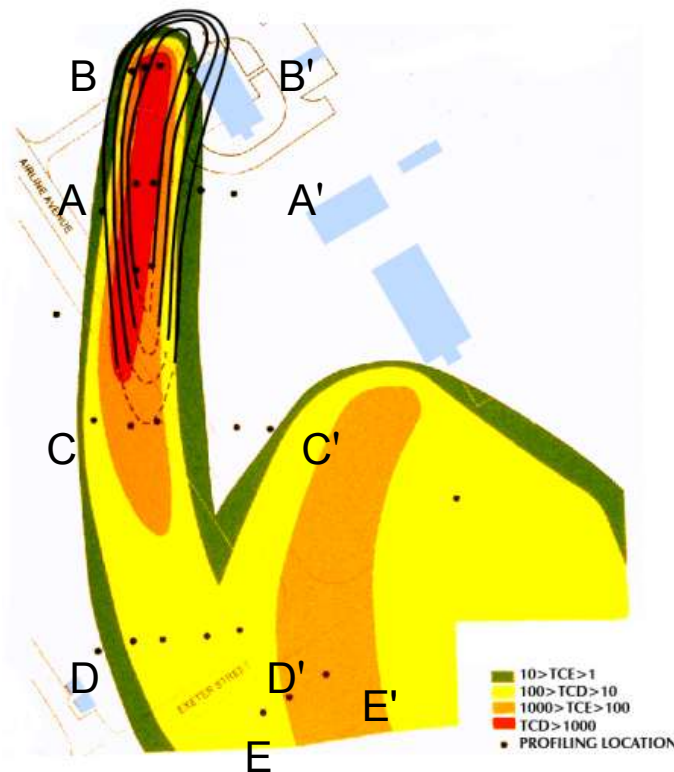

- ◆ VOC and POL release site
- ◆ VOCs potentially affecting two bedrock supply wells
 - Concern over DNAPL in bedrock
- ◆ Prior monitoring well investigation did not accurately characterize the plume
 - Defined as “short plume”
- ◆ 5 Modified Waterloo Profiler transects performed normal to plume axis
 - A - A' = Downgradient of source
 - B - B' = Through source area
 - C - C' / D - D' / E - E' = Downgradient plume delineation

Notes

- ◆ The site is a military maintenance shop at Pease AFB, Maine (the building located along the B-B' transect).

There was a ditch running adjacent to the facility (to the left of the building, where the heart of the source is and along the road that leads to Airline Avenue). The ditch received operational discharges of VOCs and petroleum, oil, and lubricants (POL).

There were concerns that VOCs from the ditch site that might affect two local bedrock supply wells; one a municipal supply well, the other a production well for a major brewing company. There was an additional concern that VOCs might enter the bedrock aquifer as dense non-aqueous liquid (DNAPL) and be a long-term source concern.

An initial site investigation effort performed using monitoring wells did not accurately characterize the plume. The plume was defined as being a “short plume” and, thus, not the source of VOCs in bedrock. This determination was based on an inaccurate horizontal delineation caused by the limited number of wells used in the investigation, an ineffective bias in their locations, and the lack of adequate vertical delineation (low resolution). The short plume is represented by the black isocontours.

An additional profiling point (to the far right) also indicated a second source (at the top of the orange plume core outline) that was previously unknown.

Profiler Cross Sections Showed TCE Plume was Sinking with Distance from Source

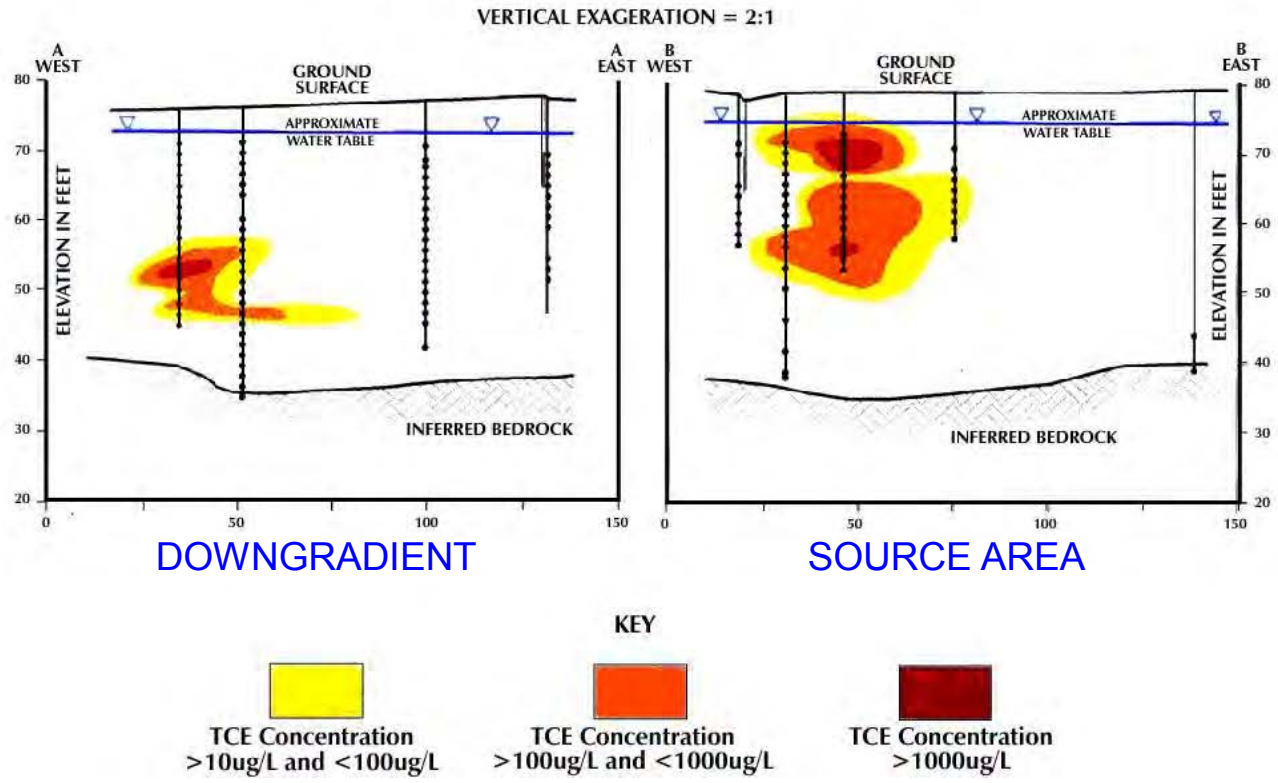

Notes

- ◆ Each vertical line is a profiling location. Each dot on each line is a vertical sampling location, spaced at a 1-foot interval. This close spacing is always necessary – but relevant in this case. The spacing between vertical sampling locations is usually from 5 or 10 foot intervals with profiles of depths of 100 feet plus.

Transect A was performed first – downgradient of the suspected source area and perpendicular to groundwater flow, based on elevations measured in previously installed monitoring wells.

Results show that the contamination is plunging from the surface disposal location and is composed of two plume cores, indicating plume morphology and behavior.

Transect B was performed next – through the suspected source area. Contaminants express near the surface and reflect the two-core morphology.

Two transects show that the plume is composed of two primary cores (masses) and is plunging by specific gravity and possibly enhanced by vertically downward gradient.

Vertical Profiling vs. Monitoring Well

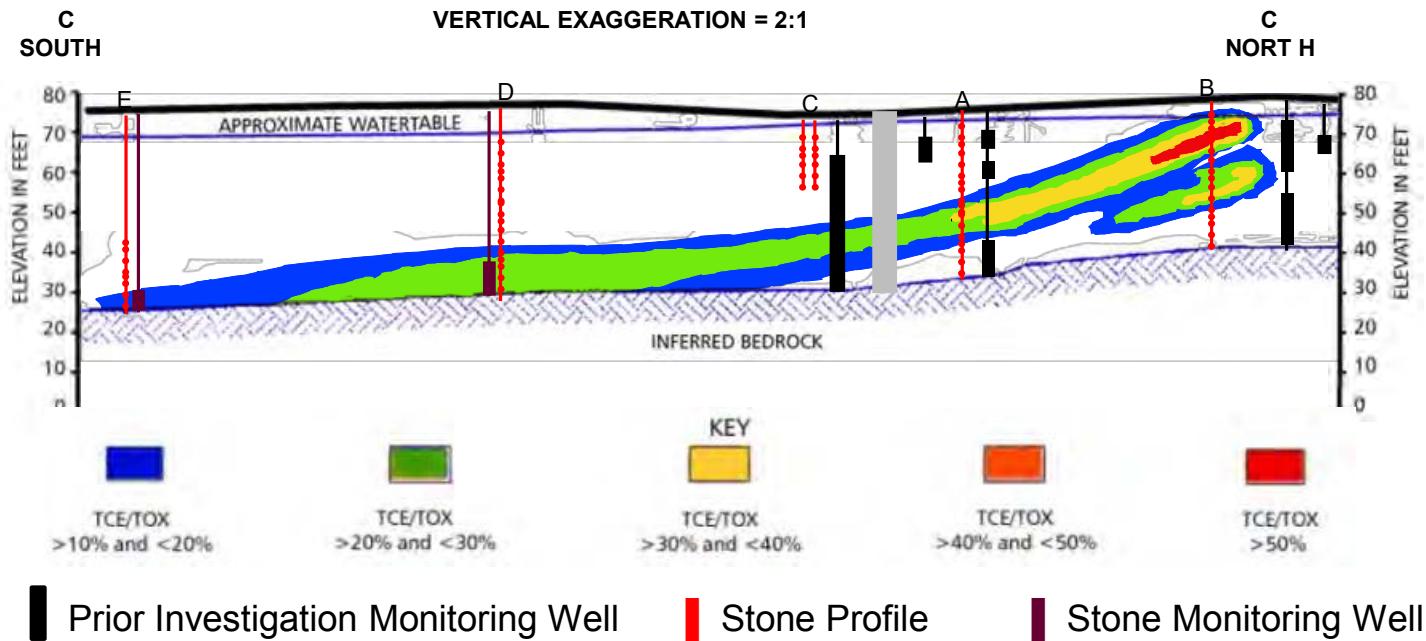

Notes



- ◆ The horizontal plume configuration shown on the slide shows the plume after vertical profiling using a transect-based strategy.

The first set of wells was installed and sampled upgradient of the suspected source areas, which generally confirmed that there was no additional upgradient source. A multi-level screened well was installed and sampled downgradient of the plume, but the screened intervals were placed above and below the plume and, therefore, missed the plume entirely.

An additional downgradient well was screened across the entire plume, and the sample concentration was thus affected by the effects of depth-integrated and flow-weighted averaging. The result was that the plume was interpreted to be at a lower concentration than it actually was. Hence, “based on available data,” the investigators determined that the plume was “short” and that it was not a source of bedrock contamination.

In response to regulator concerns that the plume had not been adequately characterized, vertical groundwater profiling was performed from ground surface to bedrock. The profiles were performed in transects oriented normal to the plume axis using a discrete interval groundwater sampler driven by direct-push technology (DPT). The sampling system provided data that allowed real-time selection of vertical sampling depths and collection of the samples. The samples were analyzed using a NELAP-accredited mobile laboratory. The laboratory provided real-time results that supported use of a dynamic work strategy approach to plume delineation.

HOW IS HRSC IMPLEMENTED?



23rd Annual NARPM Training Program

1-35

The Triad Approach

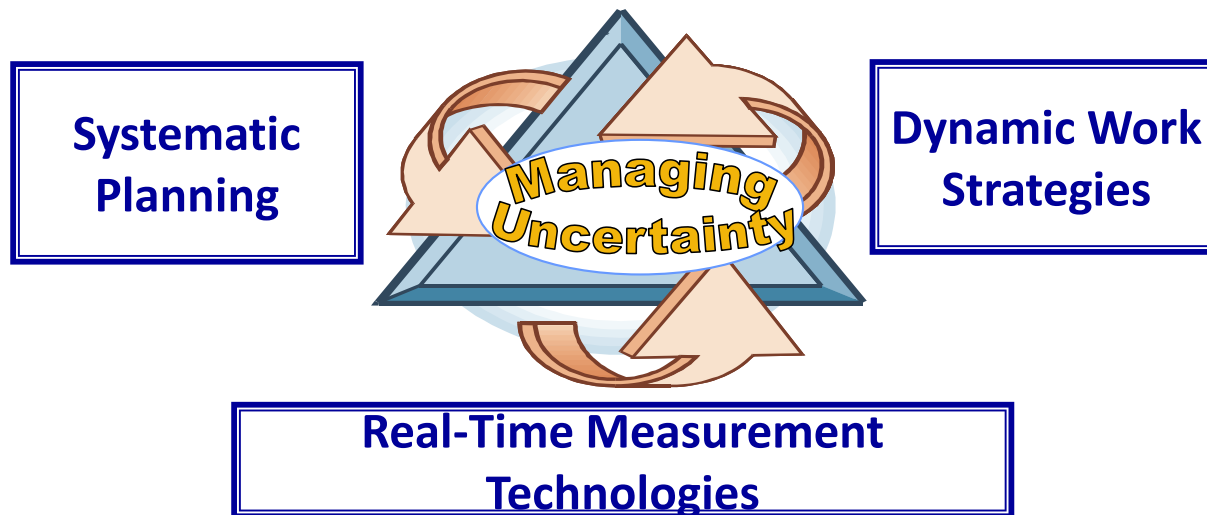

Synthesizes practitioner experience, successes, and lessons learned into an institutional framework

Notes



- ◆ The Triad Approach is an integrated method for managing uncertainty and is comprised of three BMPs.
 - » Systematic planning - identifies all necessary elements based on stakeholder input and leads to a DWS that specifically targets the collection of data using real-time measurement technologies that feed directly into critical decisions. The systematic planning component reduces the uncertainty associated with potential reuse, regulatory and risk-based cleanup levels, potential remedial actions, exit strategies, and stakeholder concerns. Under Triad systematic planning, the CSM plays a critical role throughout the project life cycle in communicating uncertainties, identifying data needs, achieving consensus, and maximizing the use of new and historical information.
 - » Dynamic work strategies (DWS) - an agreed upon sequence of dynamic data collection activities that efficiently address identified project concerns using real-time information to reduce and manage project, site and decision uncertainty. Streamlined work plans developed in the context of a project's regulatory framework are used to document DWS. Uncertainty is managed in real-time using the decision logic diagrams and other quality control (QC) elements of the DWS.
 - » Real-time measurement technologies - include any data generation mechanisms that provide information in a time-frame sufficient to drive DWS. These technologies help manage uncertainty by providing reliable measurement or collection and analysis of environmental media at a much greater density than is typically economically possible with conventional sampling and analytical methods. Together with the DWS, real-time technologies are used to focus when and where collaborative sampling and analyses can provide the greatest benefit.

The Triad Approach is designed to manage all sources of project uncertainty. Inadequately managed site uncertainties foster stakeholder indecision, which is a major source of project bottlenecks and potentially unnecessary work in the form of multiple investigation mobilizations. Impacts of this nature can directly result in significant cost increases and schedule extensions. In the worst case, uncertainty can result in the selection and implementation of ineffective remedial strategies. Ultimately, uncertainty results in site closures being delayed or difficulty in reaching remedy objectives.

Key CSM Paradigm

Are You Effectively Using Data or Confusing With Data?

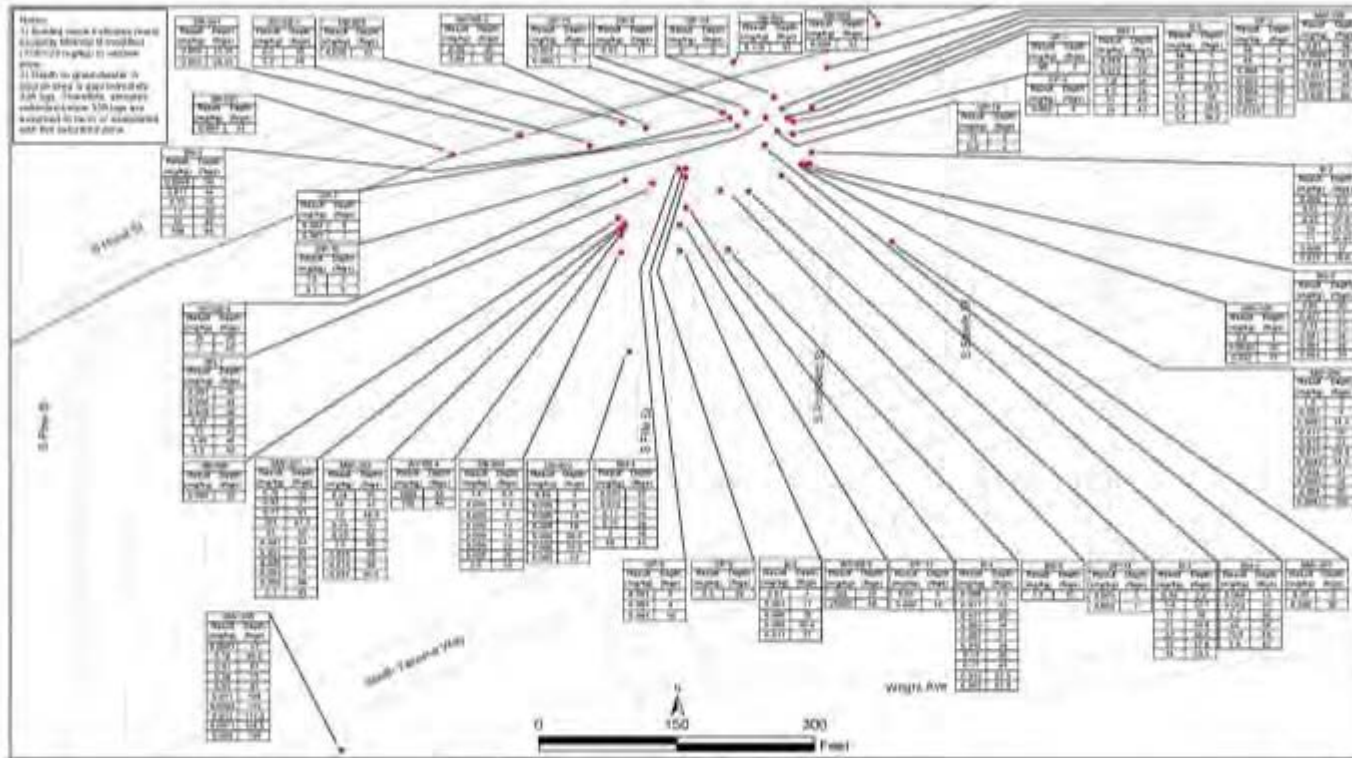

Well 12A Superfund Site
Tacoma, Washington

Figure 2-6
Trichloroethylenes in Soil

Notes



- ◆ This slide shows an example of good data provided as a CSM in a manner that can be overwhelming. How effectively can stakeholders understand contaminant distribution and relevance with this 2-D visualization? Good communication is key to obtaining stakeholder consensus, and providing useful data in a complicated way may impede understanding and agreement on the path forward.

Emerging CSMs: 3-D Visualization and 4-D (Time) Visualization

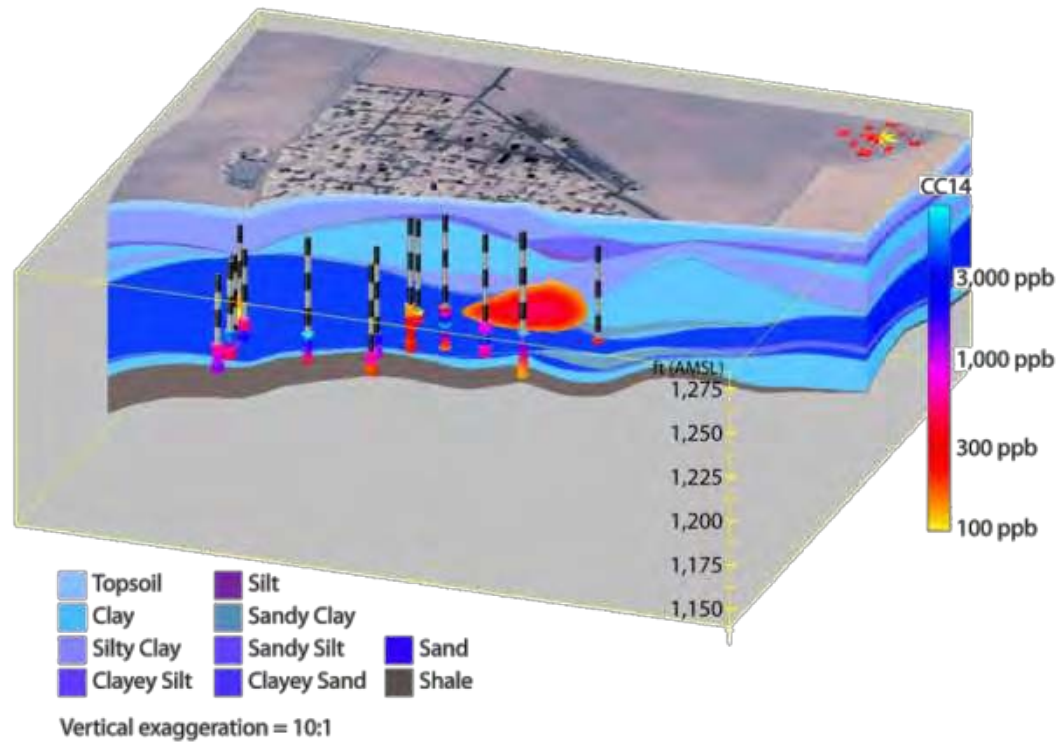

Source: Sundance Environmental & Energy

Notes

- ◆ Three-dimensional (3-D) visualization and 3-D visualization shown over time (4-D) are being used with increasing frequency to improve the effectiveness of environmental investigation and cleanup efforts. Visualization and analysis methods can be used to support projects at various stages in a project lifecycle and can help resolve a number of common, but critical, issues at environmental cleanup sites.

Source: Sundance Environmental & Energy

Internet

An Internet Seminar called “Use of Geostatistical 3-D Data Visualization/Analysis in Superfund Remedial Action Investigations” was delivered on September 23, 2011. The presentation: (1) described the setup and use of 3-D data visualization systems; (2) showed how visualization and analysis can help resolve a number of common, but critical, issues at environmental cleanup sites; (3) identified BMPs developed from a broad range of Superfund site 3-D visualization applications; (4) described quality control procedures when using 3-D visualization for analyzing existing data in EPA investigations; (5) and presented guidelines for contracting 3-D visualization and analysis services. A complete archive of this seminar is available for free download and replay at: www.clu-in.org/live/archive/.

Questions?



Module 2 – Subsurface Heterogeneity

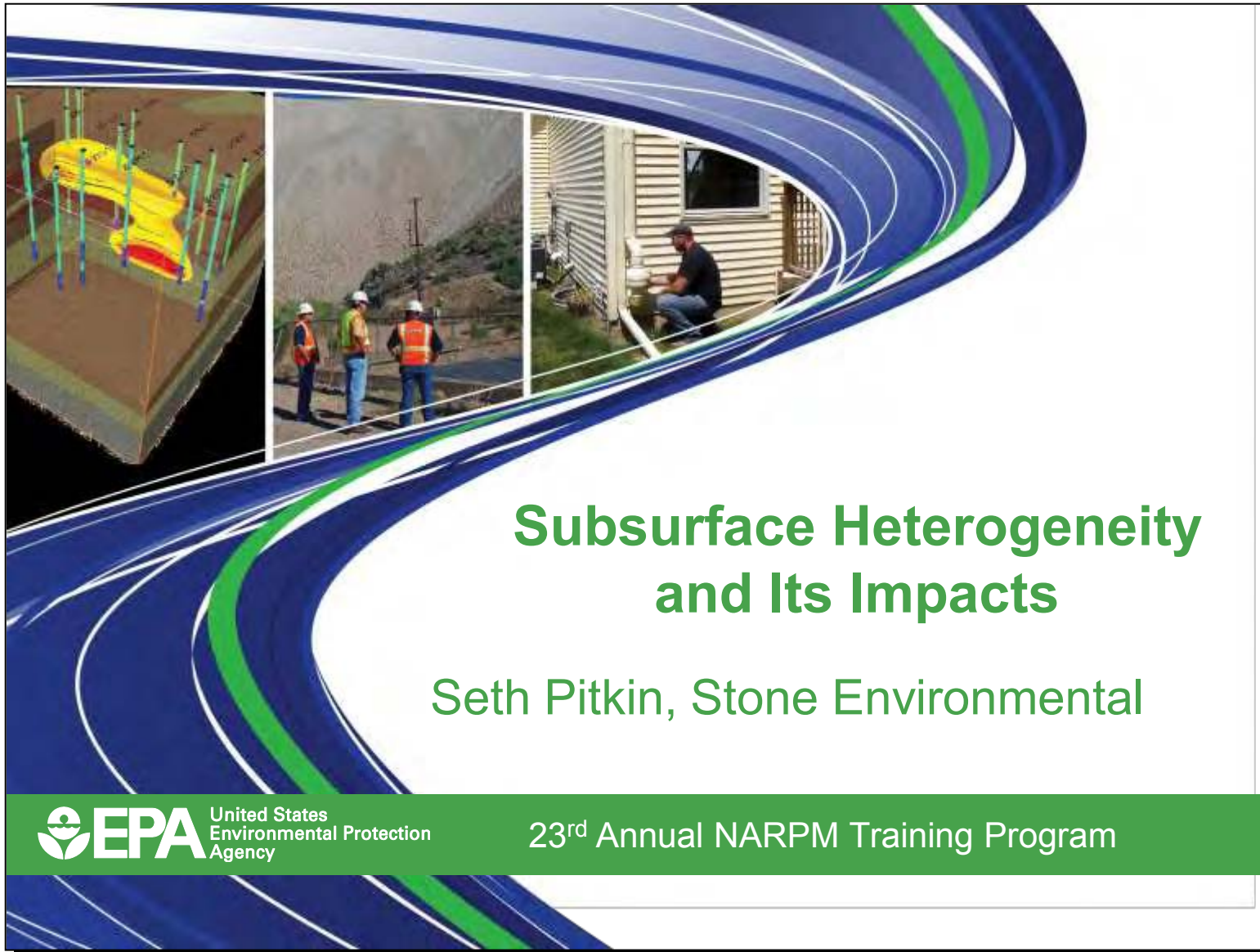

Subsurface Heterogeneity and Its Impacts

Seth Pitkin, Stone Environmental

 **EPA** United States
Environmental Protection
Agency

23rd Annual NARPM Training Program

Subsurface Environments: No Place for Low Resolution



- Porosity
- Hydraulic Conductivity
- Hydraulic Head/Hydraulic Gradient
- Capillary pressure
- Geochemistry

Notes



- ◆ Where exposed to visual observation, the heterogeneity and spatial scales of variability of subsurface geologic environments are obvious. In environments where porosity, hydraulic conductivity capillary pressures and geochemistry change at the centimeter to meter scale it is not sufficient to sample at the scale of meters and tens of meters (or larger). Measurements must be made at scales that are commensurate with the spatial scales of the environment.

Porosity

- ◆ Ratio of volume of void space to total volume of medium
- ◆ Where the fluids reside
- ◆ NOT the same as Permeability or Hydraulic Conductivity
 - Clay has a very high porosity but a very low permeability
- ◆ Particle size distribution and sorting
 - Well sorted (poorly graded) ... uniform grain size
 - Poorly sorted (well graded) variety of grain sizes

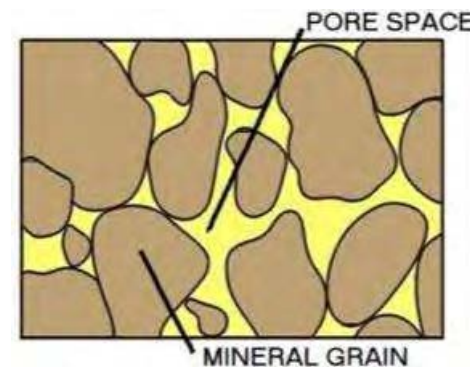

Notes



- ◆ The pore spaces are where groundwater and contaminants exist. It is important to keep in mind that porosity and permeability are not the same thing. Porosity is required for a material to be permeable, but high porosity does not equal high permeability. Clays have significantly greater porosity than sand, but are orders of magnitude less permeable than sands.

Dual Porosity Systems

- ◆ Systems in which there are (relatively) high and low permeability units
- ◆ Nearly all advective flow takes place through the pores in the high permeability materials (mobile porosity)
- ◆ Water in the saturated pore spaces in the low permeability materials (immobile porosity) is dominated by diffusive, rather than advective flux
- ◆ Pore water in the low permeability materials essentially serves as storage for solutes

Notes

- ◆ Historically, hydrogeologists have been interested in the relatively high permeability portions of flow systems and have viewed low permeability units as objects which confine or separate the permeable units.

A dual porosity system is one in which there are units with significant porosity but low permeability (for example, silts and clays or very poorly sorted materials like tills) and other units with significant porosity and high permeability.

Flow (or advection) takes place in the high permeability zones, typically called the mobile porosity. Flow typically bypasses the lower permeability zones (typically called the immobile porosity). However, diffusive flux into the immobile porosity results in significant storage of solutes in the immobile porosity. This stored solute mass can later diffuse back out of the immobile porosity and act as a long term secondary source of contamination.

Dual Porosity in Unconsolidated Media

Immobile Porosity
Relatively low permeability:
bypassed by advective flow
and dominated by diffusive
flux

Mobile Porosity
Relatively high
permeability and
dominated by advective
flow

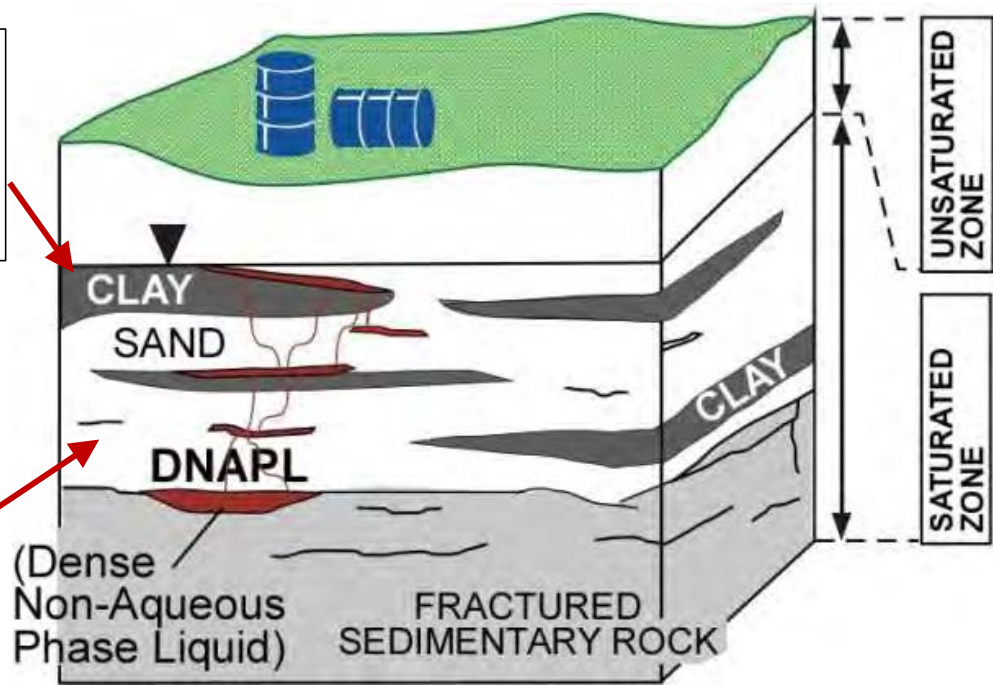

Source: Chuck Newell and Tom Sale

Notes

- ◆ This diagram was prepared by Chuck Newell and Tom Sale to illustrate their 14-compartment model which will be discussed later. The diagram shows low permeability (immobile porosity) layers interspersed with higher permeability sands (mobile porosity) in a flow system into which a DNAPL has been released. The low permeability layers have higher capillary pressures than the sands and act as barriers to DNAPL flow. Transport in the mobile porosity is dominated by advection (or active flow) while transport in the immobile porosity is dominated by diffusion.

Diagram taken from Sale, Tom and Charles Newell, 2011. [A Guide for Selecting Remedies for Subsurface Releases of Chlorinated Solvents](#). ESTCP Project ER-200530.

Dual Porosity in Fractured Rock

Small Fracture Porosity and
0.1 to 0.001%

Large Matrix Porosity
2 to 25%

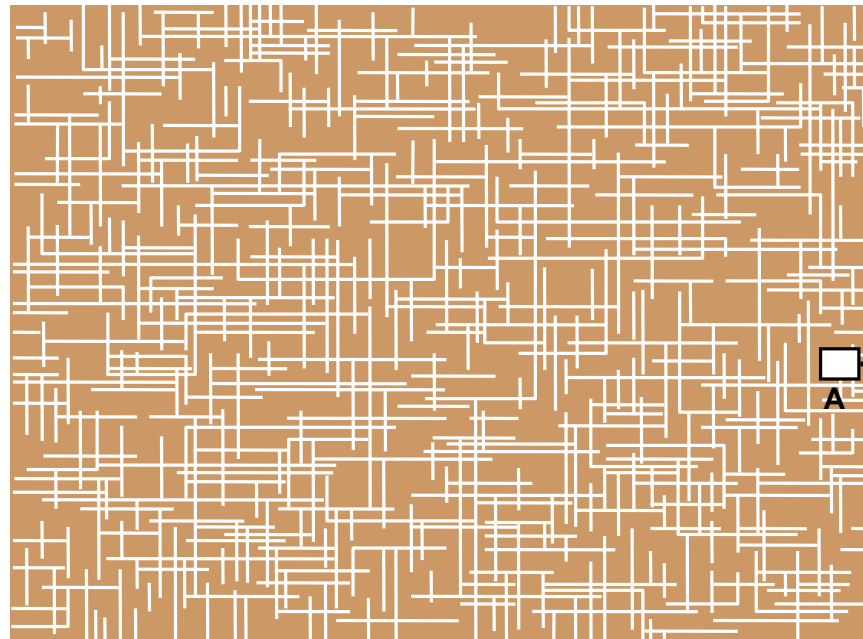

DETAIL A
mineral particle

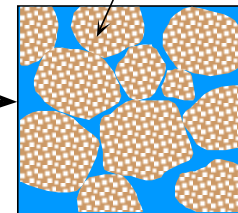

Microscopic
view of rock
matrix

Notes

- ◆ In fractured porous media, such as sedimentary rocks, the fractures represent the mobile porosity and the rock itself, or the matrix (as it is often called) is the immobile porosity. The matrix porosity is called the primary porosity and the fractures are called the secondary porosity. Essentially all the flow occurs in the fractures, but the secondary porosity is very small in these systems, ranging from 0.1 to 0.001%. The matrix (primary) porosity is quite large in comparison ranging from perhaps 2% to 25%. This primary porosity represents a very large storage volume for solutes.

Diagrams from Professor Beth L. Parker University of Guelph G360 - Centre for Applied Groundwater Research.

Hydraulic Conductivity

- ◆ Measure of the “ease” with which a medium transmits water
- ◆ Permeability (k): property of the medium
 - $k = cd^2$; where c = proportionality constant of the medium and d = mean grain diameter. Units of area (L^2)
- ◆ Hydraulic Conductivity (K): property of the medium and the fluid
 - $K = k (\rho g / \mu)$; units of velocity (L/t) where:
 - ρ = density of fluid (M/L^3)
 - g = gravitational constant (L/t^2)
 - μ = viscosity of fluid ($M/L/t$)

Notes

- ◆ Hydraulic conductivity is one of the most fundamental hydrogeological properties. It reflects the relative ease with which water can flow through a medium such as a clay, silt, sand or gravel. It is analogous to electrical conductivity in that sense. The terms permeability and hydraulic conductivity are often used interchangeably, but permeability is a property of only the medium, whereas hydraulic conductivity is a function of the permeability AND the properties of the fluid flow through the medium, specifically the density and viscosity of the fluid. The distinction becomes important for systems in which several fluids may coexist, for example air, water and DNAPL would represent a three-phase flow system in which each fluid has a different conductivity within the same permeability regime.

Homogeneity and Isotropy

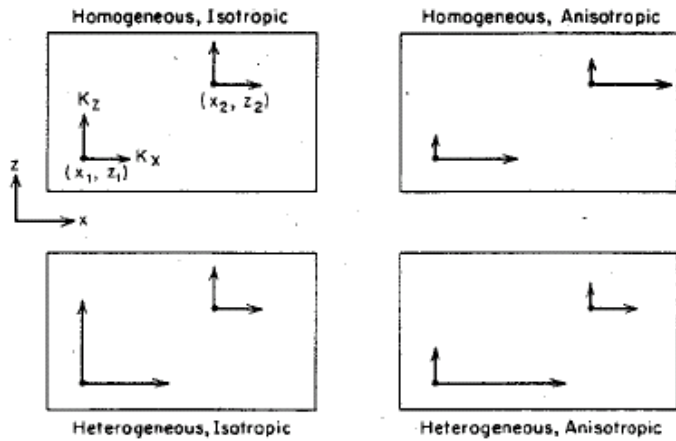

(from Freeze and Cherry, 1979)

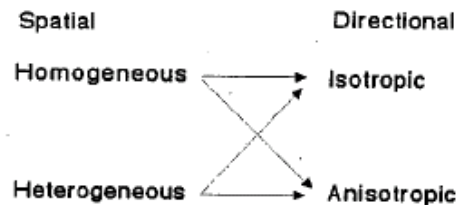

- ◆ Homogeneous: Variable has same value regardless of position in space
- ◆ Isotropic: value of variable is dependent on direction
- ◆ Homogeneous, isotropic aquifers do not occur in nature

Notes

- ◆ Homogeneity and isotropy are terms that can apply to any number of variables but in this context are usually used in reference to hydraulic conductivity. Homogeneity refers to a variable that has the same value regardless of where it is measured in the system. Isotropy means that a variable has the same value regardless of the direction in which it is measured. An anisotropic aquifer would have different values for hydraulic conductivity depending on the direction in which it was measured. Typically, analytical solutions to flow equations assume that aquifers are homogeneous and isotropic. These simplifying assumptions make the math work. Unfortunately such aquifers do not exist in nature.

It is often expected that porous media such as sandy aquifers are anisotropic such that the vertical hydraulic conductivity is substantially lower than the horizontal hydraulic conductivity. However, horizontal anisotropy also occurs. One important effect of anisotropy is that actual flow does not occur in the direction of the hydraulic gradient, but rather at some angle from it. This makes prediction of the contaminant transport significantly more difficult.

Source: Freeze, R. Alan, and John Cherry. Groundwater. Prentice-Hall, 1979.

Distribution of K at CFB Borden – Beach Sand (adapted from Sudicky, 1986)

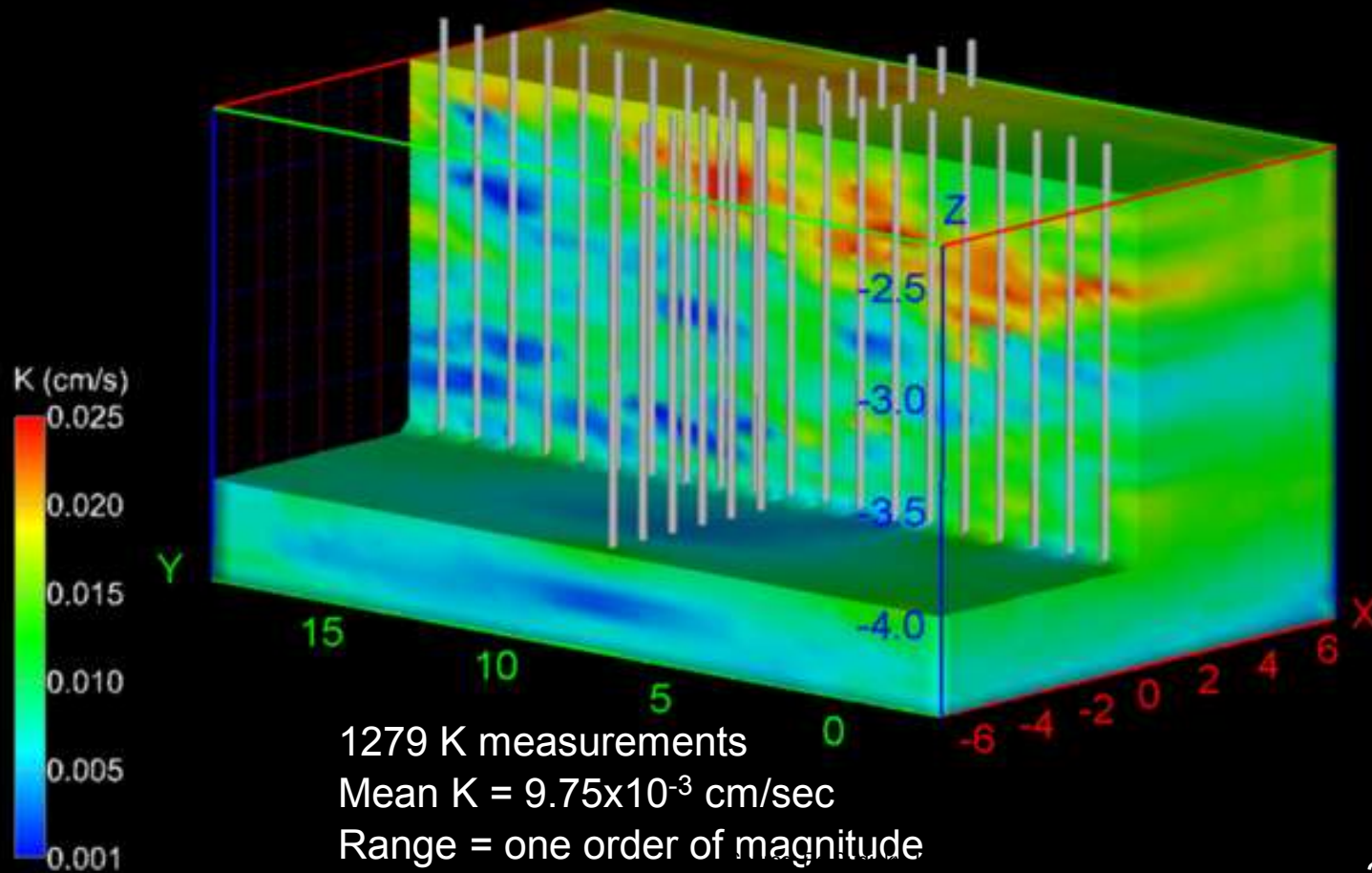

2-9

Notes

- ◆ The simplifying assumption of homogeneity implicit in much of the classical hydrogeological applications leads to descriptions of the hydraulic conductivity of an aquifer. However, aquifers have many different zones of many different hydraulic conductivity values. It is the spatial distribution of these values that determines the paths that groundwater actually follows and the routes by which contaminants are transported. The spatial structure of hydraulic conductivity is closely related to the nature and degree of hydrodynamic dispersion in aquifers.

This image shows the results of work done by Ed Sudicky at the University of Waterloo at the time of the Stanford-Waterloo Natural Gradient Tracer Test at Canadian Forces Base Borden in Ontario, Canada. The interpolation and visualization in this image was done by Seth Pitkin using Ed Sudicky's data. Ed Sudicky collected a series of 2 meter long cores spaced 1 meter apart horizontally in a cross pattern. He then divided the cores into 5 cm thick segments and ran permeameter tests on each segment, resulting in 1,279 measurements of hydraulic conductivity. The Borden aquifer is commonly referred to as relatively homogeneous in appearance and is a sand deposited in a beach environment. This image shows the distribution of the K values in 3 dimensions. Note that there is a substantial vertical exaggeration in the image. The spatial structure of hydraulic conductivity is such that there are thin zones of high K material adjacent to thin zones of lower K material.

Source: Ed Sudicky, University of Waterloo

Research originally published in:

Sudicky, E.A., 1986. A Natural Gradient Experiment on Solute Transport in a Sand Aquifer: Spatial Variability of Hydraulic Conductivity and Its Role in the Dispersion Process. *Water Resources Research* Vol. 22, No. 13 pages 2069-2082, December.

Hydraulic Conductivity Correlation Lengths

Location	Horizontal K Correlation Length (m)	Vertical K Correlation Length (m)	Investigator
Borden, Ontario	2.8	0.12	Sudicky (1986)
Otis, ANGB	2.9 – 8	0.18 – 0.38	Hess et al. (1992)
Columbus AFB	12.7	1.6	Rehfeldt et al. (1992)
Aefligan	15 – 20	0.05	Hess et al. (1992)
Chalk River, Ontario	1.5	0.47	Indelman et al. (1999)

Notes

- ◆ Other investigators have since performed similar studies and have found similar results. With the exception of Columbus AFB, all of the investigators have found vertical correlation lengths in the centimeter scale with horizontal correlation lengths in the meter to a few tens of meters.

References:

Hess, Kathryn M., Steven H. Wolf and Michael Celia, 1992. Large-Scale Natural Gradient Tracer Test in Sand and Gravel, Cape Cod, Massachusetts. *Water Resources Research*, Vol. 28, No. 8, pages 2011-2027, August.

Indelman, P., 1999. Averaging of Unsteady Flows in Heterogeneous Media of Stationary Conductivity. *Adv, Water Resources*. 22(7) pages 729 – 740.

Rehfeldt, K.R., J.M. Boggs, and L.W. Gelhar. 1992. Field study of dispersion in a heterogeneous aquifer. 3: Geostatistical analysis of hydraulic conductivity. *Water Resources Research* 28, no. 12: 3309–3324.

Sudicky, E.A., 1986. A Natural Gradient Experiment on Solute Transport in a Sand Aquifer: Spatial Variability of Hydraulic Conductivity and Its Role in the Dispersion Process. *Water Resources Research* Vol. 22, No. 13 pages 2069-2082, December.

Hydrodynamic Dispersion

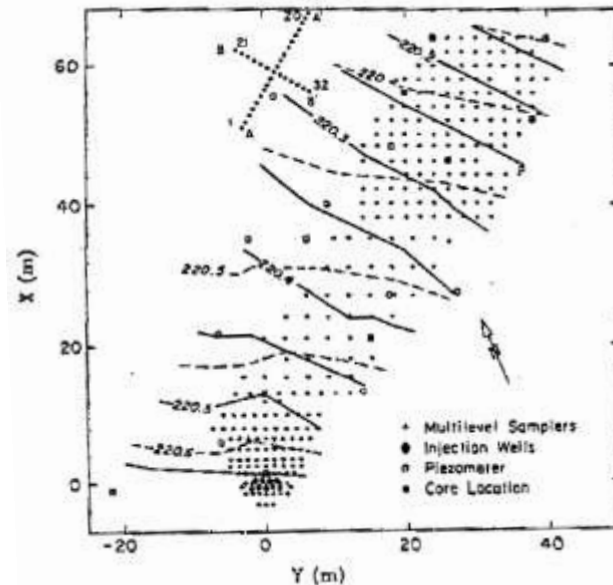

Stanford-Waterloo Natural Gradient Tracer Test
Layout, Water Resources Research, 1982

- ◆ Natural Gradient Tracer Tests
 - Sudicky 1979
 - Stanford/Waterloo – 1982
 - USGS Cape Cod – 1986
 - Rivett et al. 1991
- ◆ Dispersion is scale (time/distance) dependent
- ◆ Transverse horizontal dispersion is weak
- ◆ Transverse vertical dispersion is even weaker
- ◆ Longitudinal dispersion is significant

Notes

- ◆ Hydrodynamic dispersion is the variable that describes the value of dispersion in the advection - dispersion equation. Dispersion accounts for spreading and mixing of solutes in groundwater as the groundwater flows through a porous medium.

Hydrodynamic dispersion is made up of a mechanical dispersion term (due to the different travel paths that “particles” of water take during their journey) plus effective molecular diffusion.

The mechanical dispersion term is the product of the dispersivity of the porous medium times the average linear groundwater velocity that was discussed earlier.

The effective diffusion coefficient is the product of the free molecular diffusion coefficient (readily available in the literature for most solutes) times the tortuosity of the medium. The tortuosity is related to the porosity and accounts for how much the travel path of the molecule deviates from linear.

TCM Plume at 322 Days

Weak Transverse Dispersion

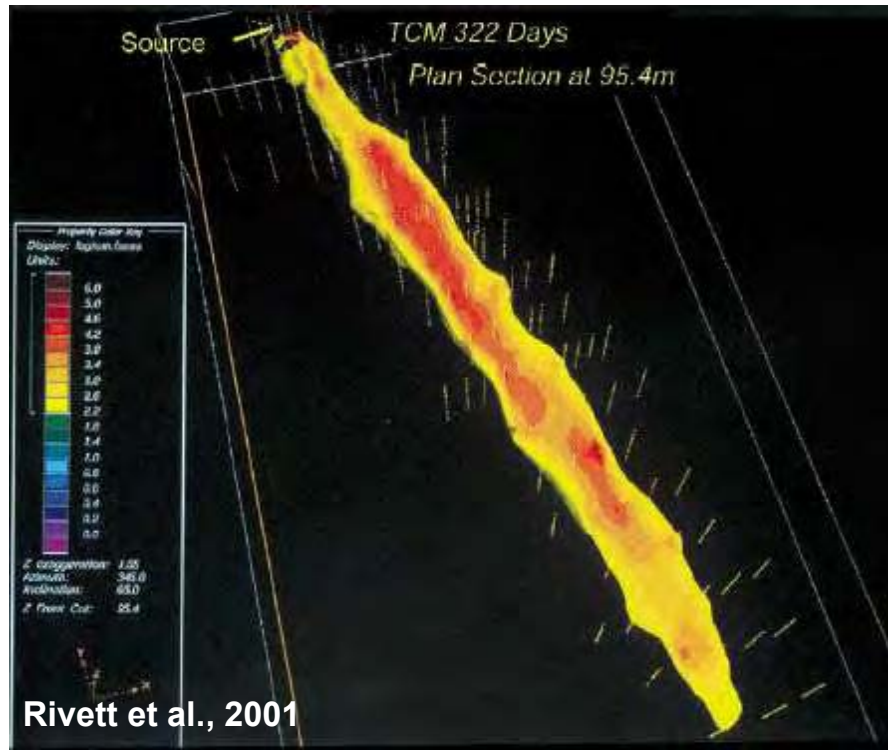

Notes

- ◆ In the 1970's and early 1980's, it was thought that hydrodynamic dispersion was a relatively strong process and that it resulted in fan shaped plumes with fairly low concentration gradients and significant dilution.

However, work beginning with Ed Sudicky's Ph.D. thesis in at the University of Waterloo in 1979 raised doubt about this view of dispersion. The Stanford Waterloo natural gradient tracer test was a seminal event in contaminant hydrogeology published in *Water Resources Research* in 1982. This large scale, rigorous and robust study indicated that transverse (at right angles to the principal direction of flow) dispersion was a weak process. Vertical transverse dispersion was found to be very weak, essentially on the order of molecular diffusion. Similar work by other researchers verified the results of the Stanford Waterloo experiment, including a large scale test conducted by the USGS at the Massachusetts Military Reservation on Cape Cod. These tracer tests used conservative tracers such as chloride to assess transport. Later experiments such as those by Mike Rivett and others used reactive contaminants such as chlorinated solvents to assess transport and further confirmed the results of the conservative tracer tests.

Note the location of the "Sudicky Star" on the plan view diagram of the Stanford Waterloo Tracer test at CFB Borden. The Sudicky Star is the location of the study of hydraulic conductivity distributions that was shown earlier.

1980's Conception of Plumes

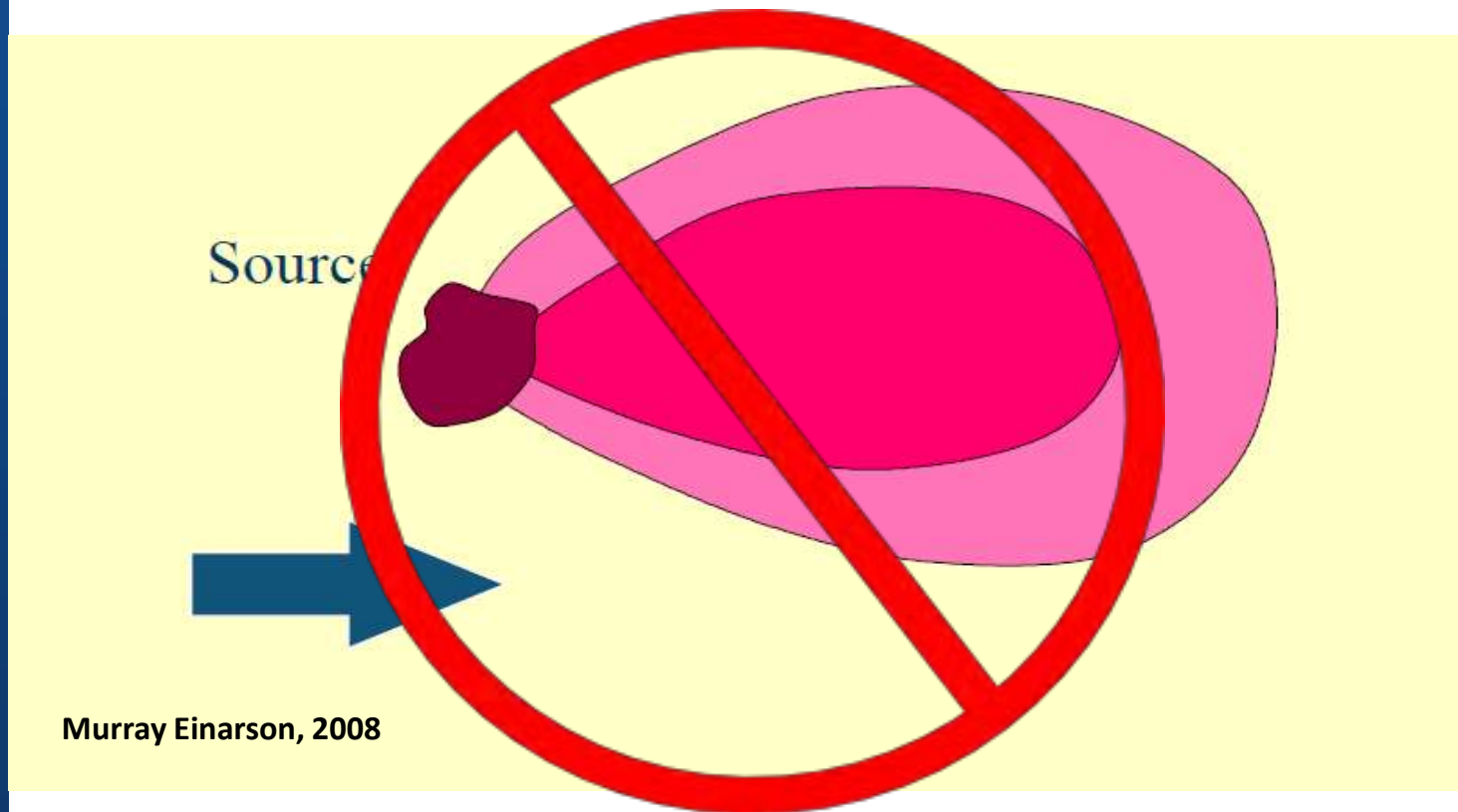

Murray Einarson, 2008

Notes



- ◆ **Beneficial for developing a more realistic CSM:** By definition, the CSM is 3-D in nature. Therefore, to effectively understand the CSM and its associated data, it should ideally be viewed three dimensionally.

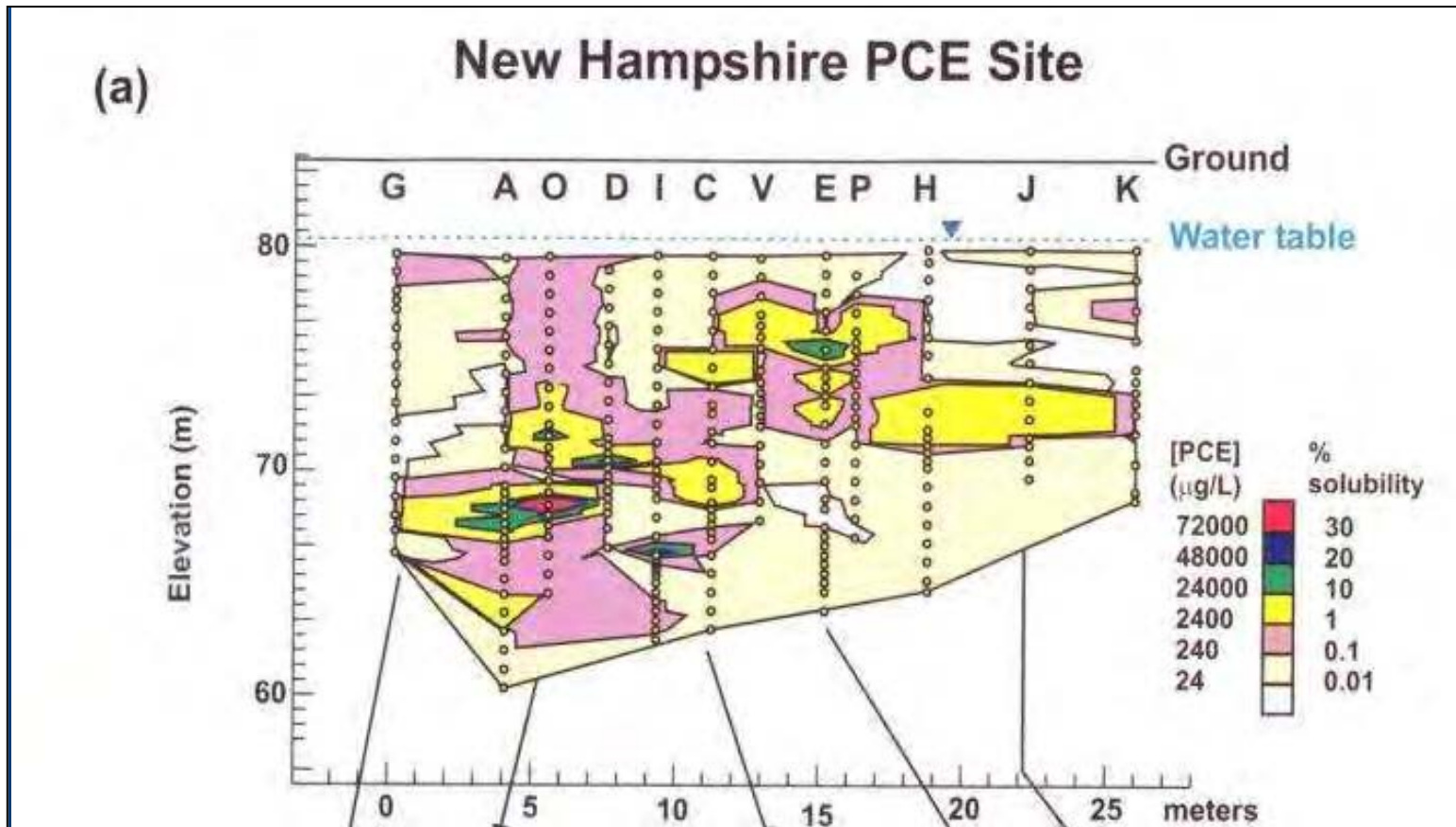

75% of contaminant mass discharge occurs through 5% to 10% of the plume cross sectional area

Optimal Spacing is ~0.5 m

Guilbeault et al. 2005

Notes

- ◆ Martin Guilbeault, Beth Parker and John Cherry were the first to report (at least in a peer reviewed format) the finding that the vast majority of contaminant mass discharge occurs through a very small percentage of the overall cross sectional area of the plume. This is a logical consequence of the weak nature of transverse hydrodynamic dispersion and the discrete and complex distribution of many source materials (particularly DNAPLs).
- ◆ Guilbeault et al (2005) used very closely (15 cm) spaced groundwater samples to define the solute distributions at three sites around North America. The finding that 75% of the mass discharge occurs through only 5 to 10% of the plume cross sectional area has profound implications for how sites need to be investigated and how remedies need to be focused.
- ◆ The authors also found that the optimal vertical sample spacing based on their work at the three sites was approximately 45 cm. This is a very close spacing and the cost of investigating sites by collecting and analyzing samples at such a close spacing would be prohibitive. This issue can be overcome through the use of collaborative data (e.g. screening with a MIP or LIF) followed by targeted sampling at the required spacing only in key portions of the profile (and plume). The use of onsite labs can also reduce the amount of sampling required by providing near real-time feedback on the spatial structure of contaminant distributions (in particular, when you are sampling outside of the 5% to 10% of the cross sectional area through which the vast majority of the flux occurs).

DNAPL Distribution Scenarios

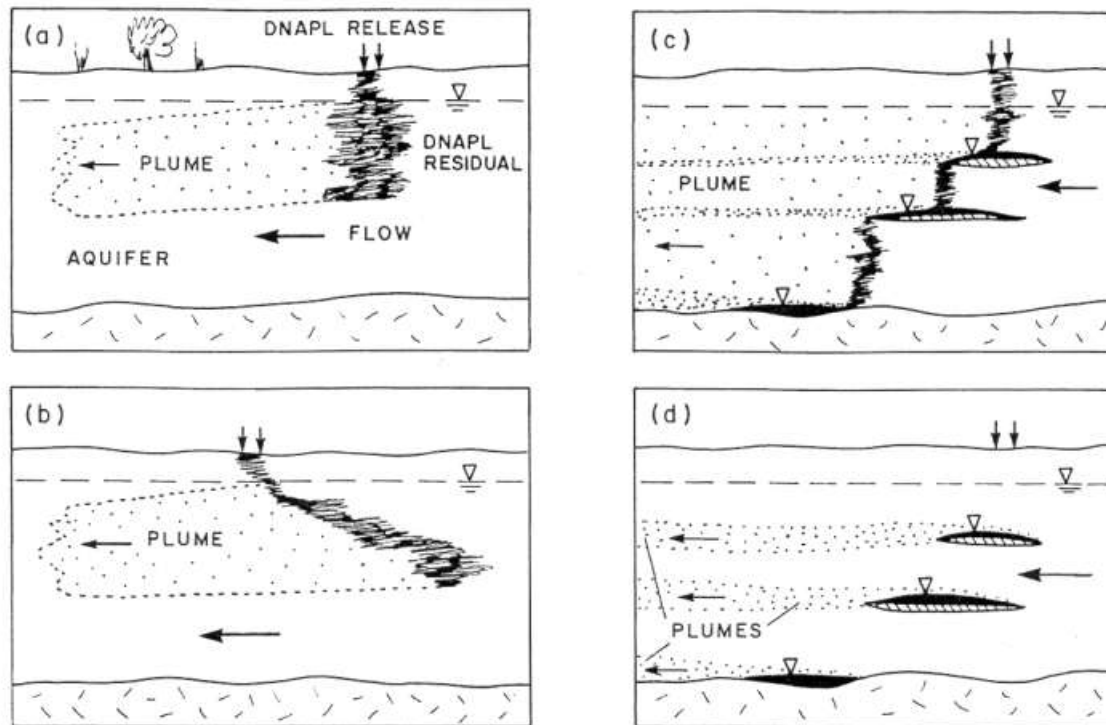

Pankow and Cherry, 1996

Notes

- ◆ Because DNAPLs are typically the non-wetting fluid and are sensitive to capillary pressure distributions, many complex DNAPL distribution scenarios occur as shown in these diagrams from the book by Pankow and Cherry. It is important to note that there may not be any indication of contamination (or low level contamination) in the vadose zone even though there is DNAPL deeper in the flow system. There need not be a trail of DNAPL leading from the point of entry to the remaining accumulations at depth.

Source: Pankow, James F., and John A. Cherry. Dense Chlorinated Solvents and Other DNAPLs in Groundwater: History, Behavior, and Remediation. Portland, OR: Waterloo, 1996



Notes

- ◆ This photograph was taken in a test pit at an experimental release site at Canadian Forces Base Borden. In this experiment by Mette Paulson (now Mette Broholm) and Bernie Kueper, two releases of the same volume of PCE were staged at adjacent locations. The PCE (dyed red with Sudan IV) was released at the surface. In the first case the DNAPL was released all at once. In the second release a Marriott bottle was used to simulate a drip release over time. Once both releases had occurred and sufficient time had passed for the DNAPL to come to rest, the sites were excavated and the distribution of the PCE was mapped. In this photo, which shows approximately a 25 cm vertical section of the test pit wall, the red DNAPL can be plainly seen. The distribution of the DNAPL is controlled by subtle soil textural changes at the millimeter scale. It does not take a clay contact to direct DNAPL flow; variability in sand grain size distribution can do it.

Source: Poulsen, M.M. and B.H. Keuper, 1992. A Field Experiment to Study the Behavior of Tetrachloroethylene in Unsaturated Porous Media. *Environmental Science and Technology*. Volume 26, No. 5 pages 889-895.

Sampling Scale and Averaging

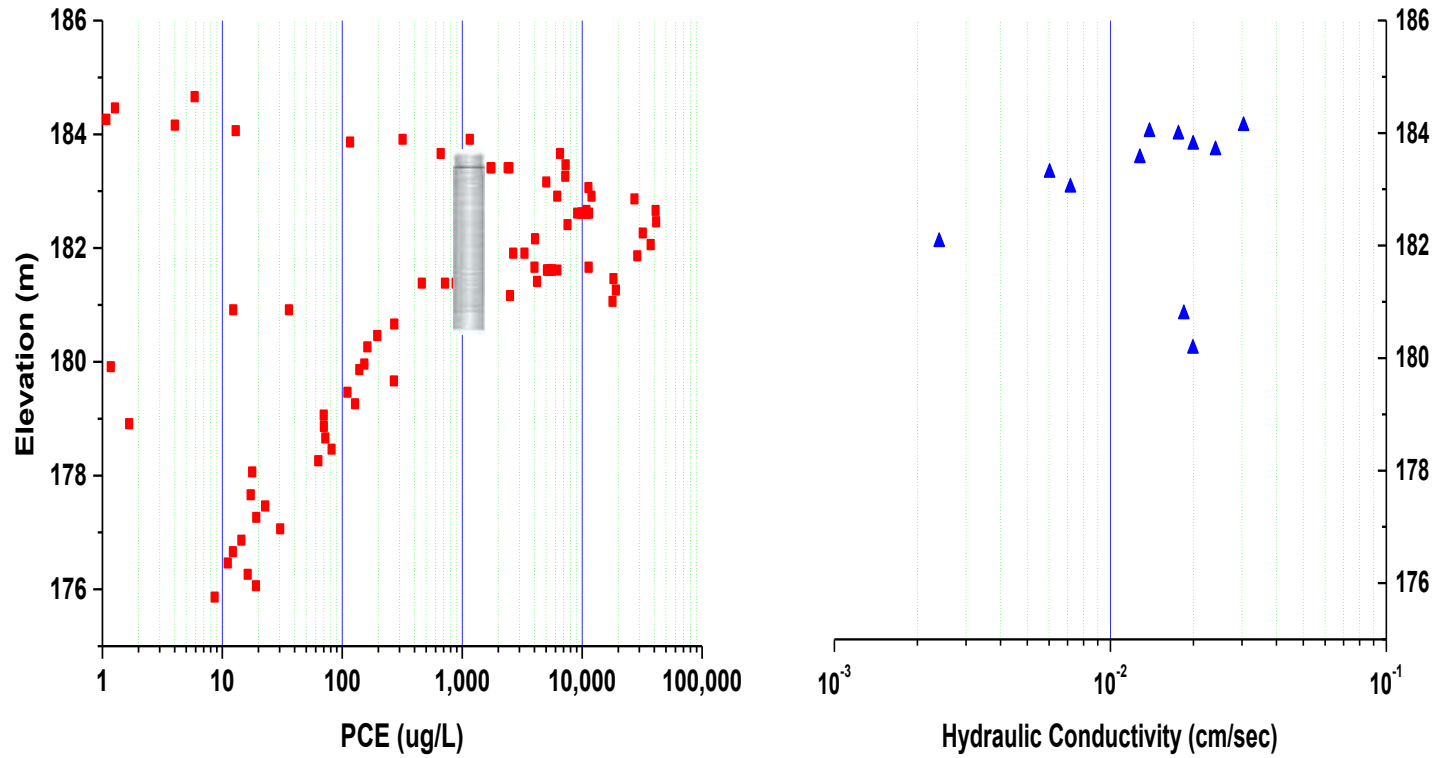

Notes

- ◆ The profile in red is the vertical distribution of PCE at a location just downgradient of a dry cleaning establishment in Angus, Ontario. The profile was produced using an early version of the Waterloo Profiler with a vertical sample interval of approximately 6 mm (1/4 inch). Approximately 100 mL of water was pumped prior to sample collection. The vertical sample spacing is 20 cm. The concentrations are shown in log scale and range from non detect to 42,000 µg/kg over approximately 2 meters. Order of magnitude changes in concentration occur over as little as 20 cm. These steep concentration gradients are a result of the weak nature of vertical transverse hydrodynamic dispersion, which is common in porous media.

Once the distribution of the PCE concentrations was understood, Pitkin installed a conventional 2-inch diameter PVC monitoring well with a sand pack extending 1 foot above the screen and a bentonite pellet plug above the sand pack. The length of the screened interval was 5 ft. The well was sampled following purging of 3 well volumes. The concentration obtained from the well was 1,007 µg/L compared with the peak concentration of 42,000 µg/L in the profiler.

The reason for the disparity in concentrations is the depth integrated flow weighted averaging caused by the monitoring well. The distribution of hydraulic conductivity along the well screen interval is shown on the right. Hydraulic conductivities range from the low end of the 10^{-3} cm/sec range to the middle of the 10^{-2} cm/sec range. The lowest K values are found in the middle of the well screen interval where the concentrations are highest. The fastest flow zones are at the top of the well screen interval where concentrations are lowest. Thus when the well is pumped for sampling most of the water that enters the well comes from the low concentration zones and relatively little enters the well from the high concentration zone in the middle. The resulting sample is weighted toward the low concentrations.

Variability Introduced by Well Sampling Method (Pease AFB: Waterloo GW Profiler vs Well)

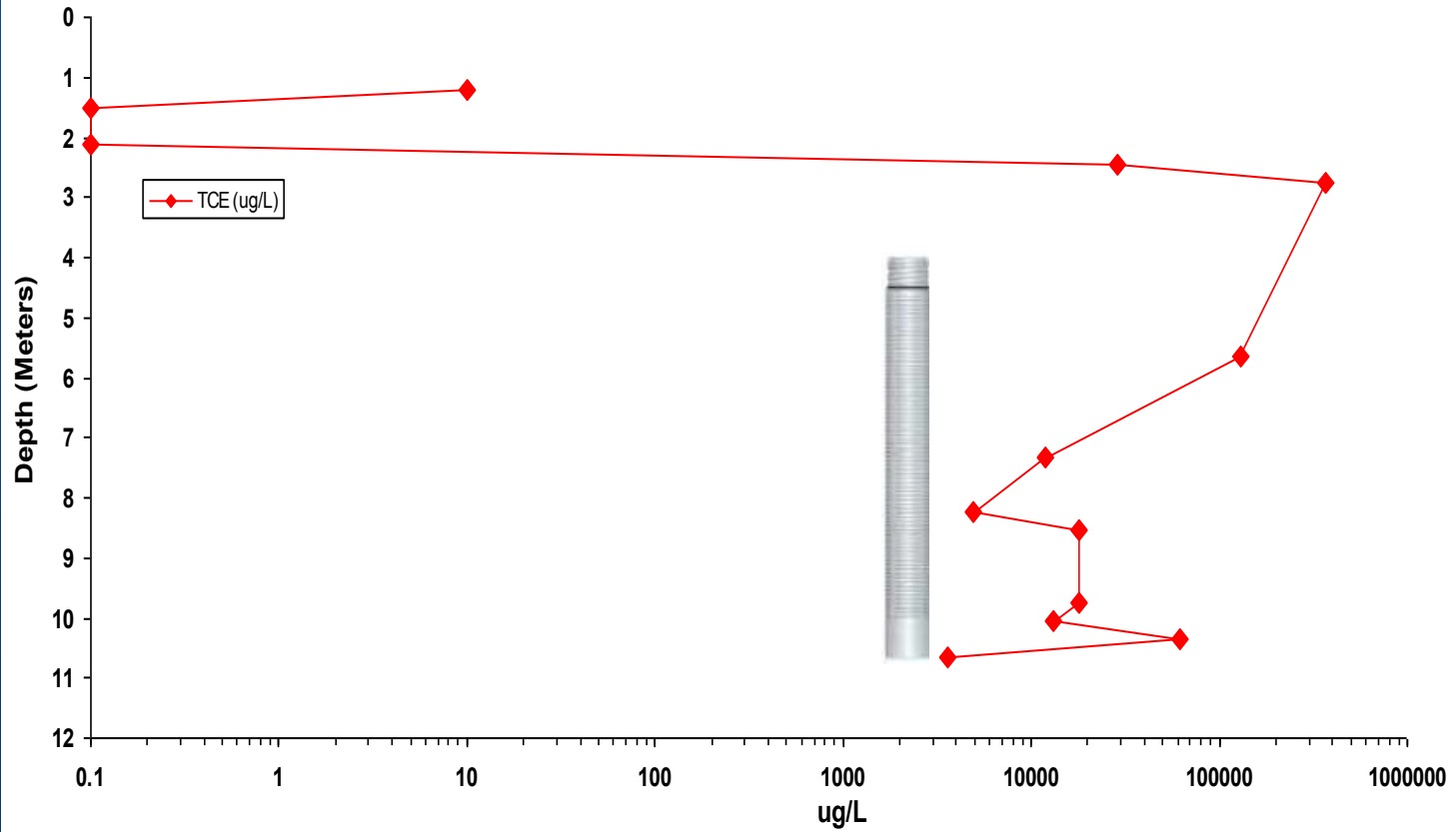

Notes

- ◆ Another problem with monitoring wells is illustrated by this profile of TCE concentrations at a location at Site 32 at Pease AFB in NH. The TCE concentration profile is very sharp with the concentrations increasing by 6 orders of magnitude (non-detect to 370,000 µg/L) over approximately 60 cm (less than 2 feet) based on samples collected with a standard Waterloo Profiler. This profile was developed immediately adjacent to a monitoring well installed as part of a standard CERCLA investigation. The well is equipped with a 15 ft screened interval. Two problems are evident with the data from this well. First, the screened interval is too deep to encounter the peak concentration zone at this location. Second, in this case the concentration obtained from the well is lower than any concentration obtained in the adjacent profile over the screened interval. This disparity is due to the sampling methodology. The well is screened across low permeability materials (clayey silt). The standard sampling procedure for this site is to that if wells have a low yield, they are purged dry and allowed to recharge prior to sampling. The action of the water trickling into the well all along the screen results in some “air stripping” of the sample and a reduction of the concentration.

This well provides data that are orders of magnitude lower than the actual concentrations present in the aquifer. This type of information is detrimental to implementation of an effective and cost efficient remedy.

Soil Sub-Core Sampling: Near- Real Time, Closely Spaced Profile

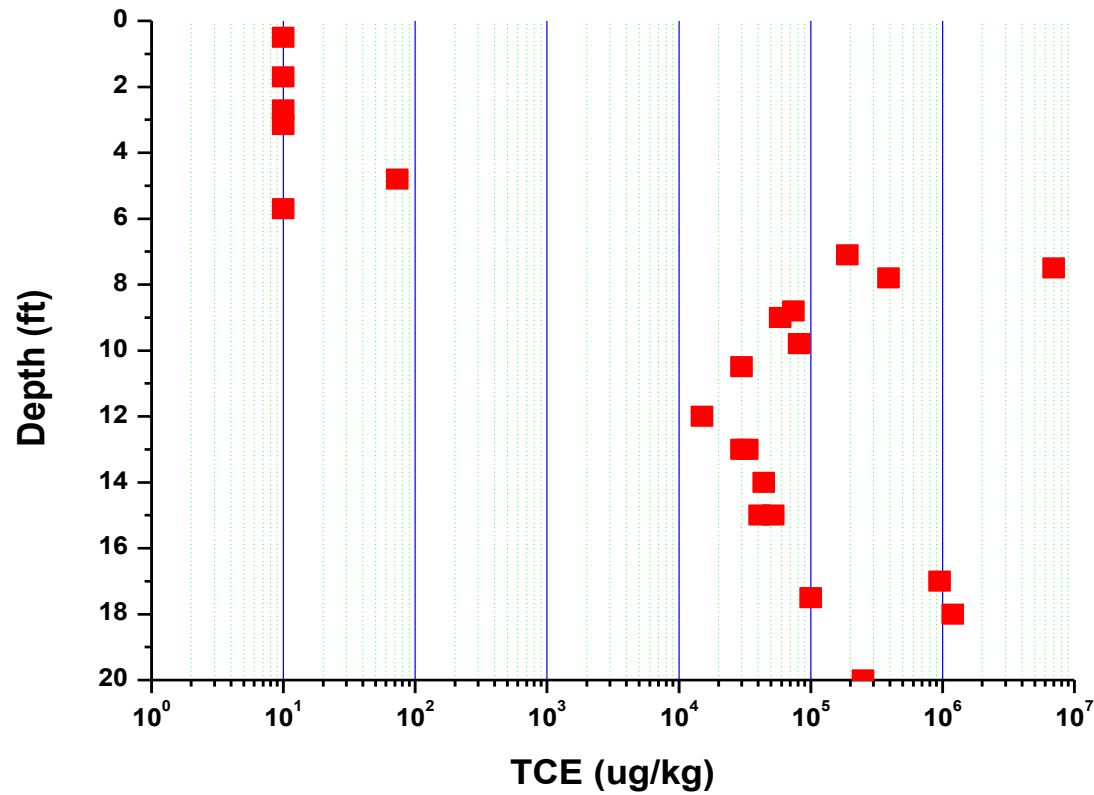

Notes

- ◆ This profile shows concentrations of TCE in soil samples at a location at Pease AFB. Vertical sample spacing is approximately 1 foot. The sample volume is very small, the sample mass is less than 5 mg. The concentration increases by nearly 6 orders of magnitude over approximately 3 ft, decreases by two orders of magnitude over the next 4 ft and increases by two orders of magnitude to the bottom of the profile.

The peak concentration at a depth of 8 ft is located in a DNAPL zone as determined from phase partitioning calculations. This zone could easily have been missed with a lower resolution sampling scheme.

Spatial Variability in Natural Attenuation

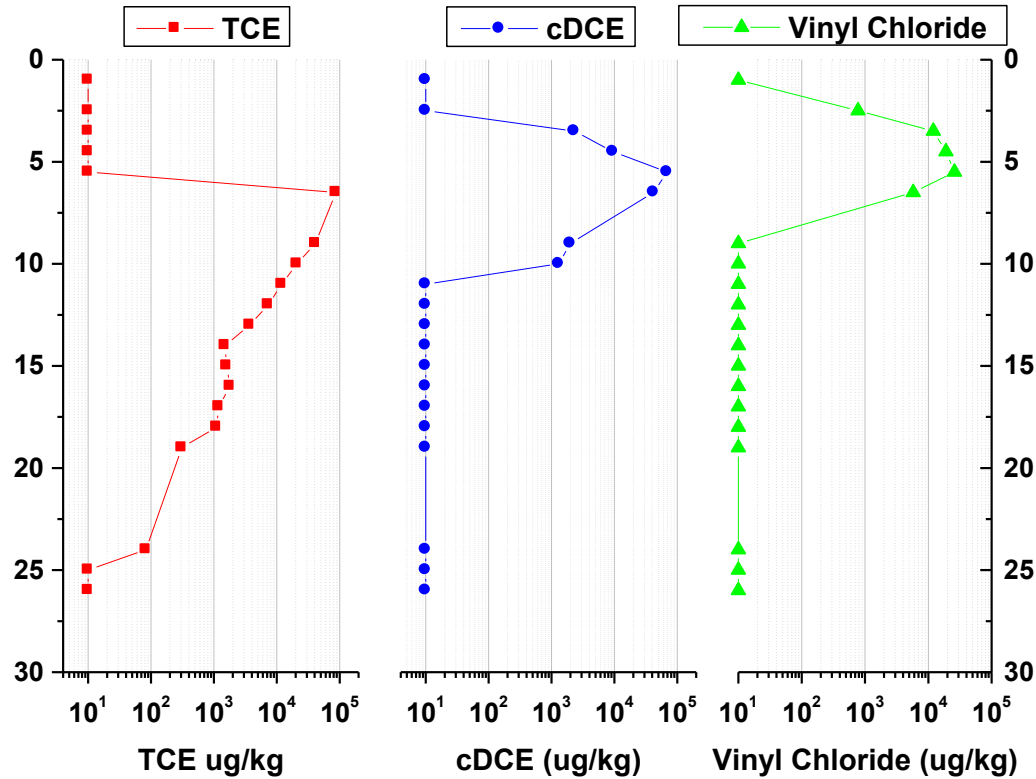

Core 27

Notes

- ◆ At core location 27 at Site 32 Pease AFB, degradation of TCE to vinyl chloride is illustrated by the vertical profiles of these compounds. The water table is found at a depth of approximately 2 ft bgs. The first detection of TCE is at 6.5 ft bgs where it occurs at 87,000 $\mu\text{g}/\text{kg}$. DCE is present at 3.5 ft and the first detection of vinyl chloride occurs at 2.5 ft. There appears to be relatively little degradation below about 12 ft bgs. It appears that this plume is degrading from the top down. Up to 26,000 $\mu\text{g}/\text{kg}$ of vinyl chloride is found in the upper 5 ft which, in some circumstances could present a substantial risk via indoor air exposure. This vinyl chloride high concentration zone is only about 3 ft thick and would be easy to miss.

Persistent Plume after Source Isolation due to Back Diffusion from Aquitard and Clay Lenses

SOURCE ZONE ISOLATED
(PHYSICAL OR HYDRAULIC)

Steve Chapman – G360 Centre for Applied
Groundwater Research, University of Guelph

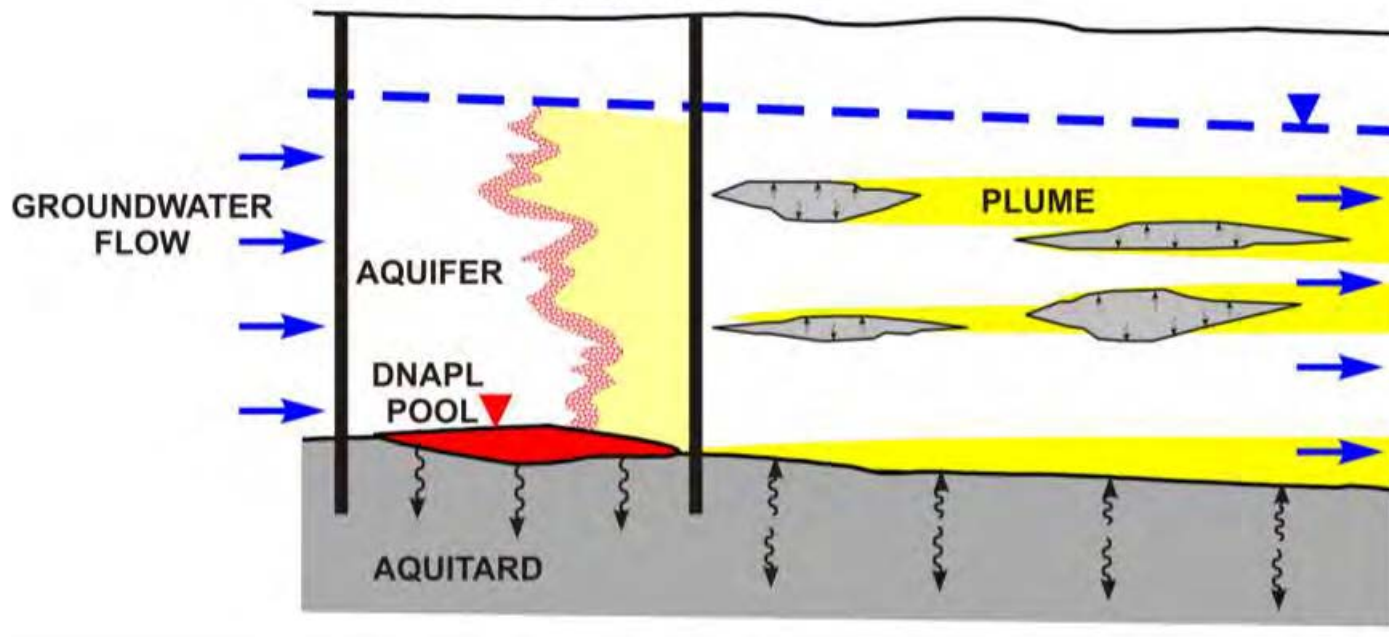

Notes

- ◆ In this diagram a remedial action has isolated the source zone from the plume. In the source zone contaminant mass continues to diffuse downward into the aquitard, but in the plume the concentrations in the permeable zones have decreased in response to being cut off of the source. Contaminants are now diffusing back out of the clay lenses and the aquitard resulting in persistent plumes emanating from those low K materials. This shows the problem presented by back diffusion where even with effective source control, MCLs cannot be achieved in the plume for extremely long periods of time.

Source: Steve Chapman – G360 Centre for Applied Groundwater Research, University of Guelph.

DNAPL Disappearance from Fractures by Diffusion

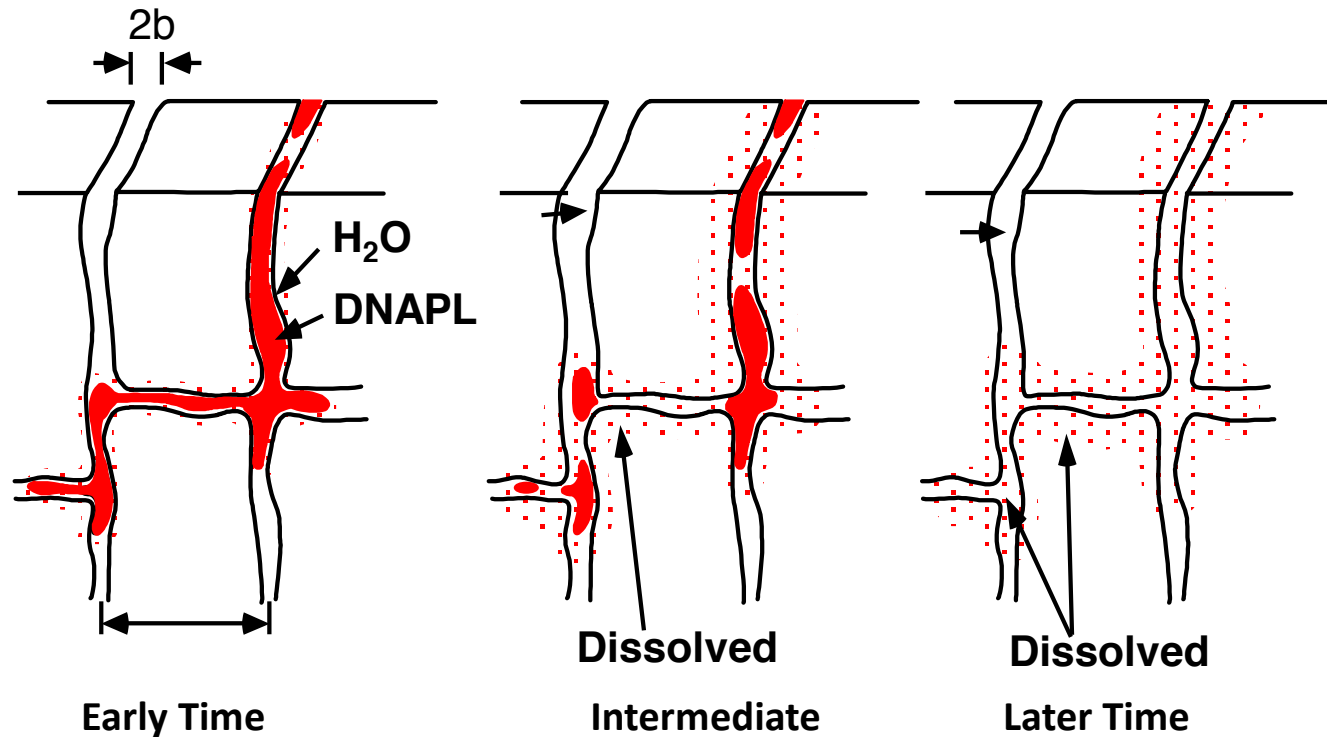

Parker et al., 1997

Notes

- ◆ The relationship between hydraulic conductivity and concentration is absolutely critical in assessment of risk and remedy selection and design. This slide shows the profile of PCE concentration and hydraulic conductivity at two locations in a plume at a dry cleaning establishment in Massachusetts. The plot on the left is at the source area. The relationship between K and C is inverse. High concentrations are found in low K zones. At a location downgradient of the source area, the relationship is direct. High concentrations are found in high K zones.

Source: Parker, Beth L., David B. McWhorter and John A. Cherry. 1997. Diffusive Loss of Non-Aqueous Phase Organic Solvents from Idealized Fracture Networks in Geologic Media. *Ground Water*. Volume 35, No. 6.

Diffusion Into Rock Matrix

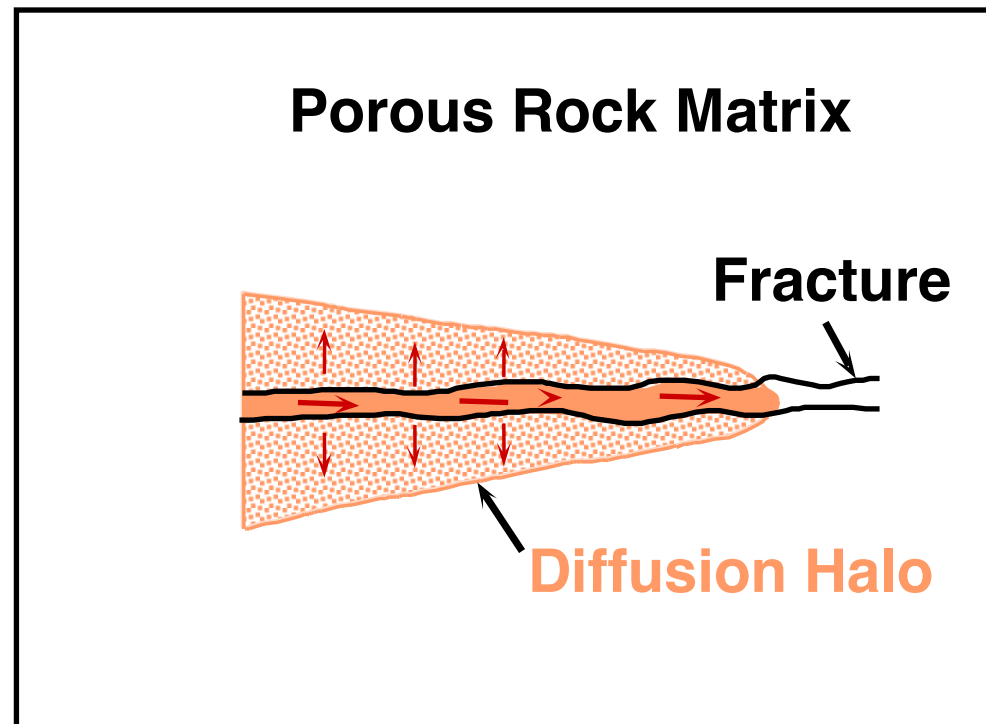

Notes

- ◆ As shown in this diagram by Beth Parker, in fractured sedimentary rock solutes migrating along a fracture set up a concentration gradient between the high concentrations in the fracture and the lower (initially zero) concentrations in the primary (immobile) porosity. Contaminant mass moves into the primary porosity by diffusion, removing mass from transport and causing retardation of the plume front. A halo of contaminant concentrations in the matrix around the fracture develops.

Source: Parker, Beth L. Robert W. Gillham and John A. Cherry 1994. Diffusive Disappearance of Immiscible Phase Organic Liquids in Fractured Geologic Media. Ground Water Volume 32, No. 5.

Summary

- ◆ This works against you
 - Heterogeneity in the subsurface occurs at a small scale
 - Dual porosity systems are common in nature and affect contaminant fate and transport
- ◆ This works for you
 - Contaminant plumes in groundwater are long and skinny not fan-shaped
 - 75% of contaminant mass occurs in a 5 to 10% section of most unconsolidated aquifers

Questions?



Module 3 – Tools



Module 3: Potentially Applicable Tools

 **EPA** United States Environmental Protection Agency

23rd Annual NARPM Training Program

Module Overview

- ◆ Tools for unconsolidated environments
 - Shallow
 - Deep
- ◆ Tools for fractured or porous media environments
- ◆ Tools for non-depth-specific applications
- ◆ Tools for groundwater and surface water interface environments



HRSC Tools Matrix

- ◆ Tool/Technology/Approach
- ◆ Target Data
- ◆ Applicable Media
 - Environment
 - Lithology
- ◆ Type of Data Generated
 - Geologic
 - Hydrogeologic
 - Contaminant
- ◆ Approximate Production Rate

HRSC Tools Matrix - Example

Tool/Technology/Approach	Target Data	Applicable Media								
		Environment				Lithology				
		Unconsolidated - Shallow (< 120 ft bgs)	Unconsolidated - Deep (> 120 bgs)	Fractured Media	Porous Media	Groundwater-Surface Water Interfaces	Gravel	Sand	Silt	Clay
CPT (Cone Penetrometer Testing) - Direct Push	Continuous stratigraphic profile and depth specific hydraulic head data (can be combined with MIP, LIF, TarGOST raman spectroscopy)	✓	◊		✓		✓	✓	✓	

Applicable
✓
May be applicable
◊

HRSC Tools Matrix - Example

Tool/Technology/Approach	Type of Data Generated														
	Geologic Data	Hydrogeologic Parameters			Contaminant Classes										
	Geologic Conditions - Quantitative	Hydraulic Head	Quantitative or relative K	Groundwater flow / flux	NAPL		VOCs			SVOCs		Metals	Explosives		
	Geologic Conditions - Quantitative	Hydraulic Head	Quantitative or relative K	Groundwater flow / flux	DNAPL (chlorinated solvents)	LNAPL	VOCs - Speciation	VOCs - Concentration	VOCs - Vertical Distribution	VOCs - Halogenated	VOCs - Nonhalogenated	SVOCs - Halogenated	SVOCs - Nonhalogenated	Metals and metalloids	Explosives and energetics
CPT (Cone Penetrometer Testing) - Direct Push	✓	✓	✓		✓	✓	✓	✓	✓	✓	✓	✓	✓	✓	✓

Applicable
✓
May be applicable
◊

HRSC Tools Matrix - Example

Tool/Technology/Approach	Approximate Production Rate		
	Approximate Production Rate - Borehole Advanced (feet/day)	Soil samples/data per day	Groundwater samples/data per day
CPT (Cone Penetrometer Testing) - Direct Push	400-500	N/A	5-10

Soil Coring Tools
Hydrostratigraphic Tools
Qualitative Tools for Contaminants
Sampling and Quantitative Tools for Contaminants

TOOLS FOR SHALLOW UNCONSOLIDATED ENVIRONMENTS



23rd Annual NARPM Training Program

3-7

Notes



- ◆ **Disclaimer:** Mention of any product or service by the EPA does not imply an endorsement. The EPA does not claim that the tools listed in this module represent the total universe of tools that could be used.

Soil Coring

Soil Coring

- ◆ Soil coring provides samples of the actual porous medium and, ideally, of the pore fluids
 - Soil cores are the baseline (or ground truth) against which other methods are evaluated
- ◆ A wide variety of techniques to obtain cores are available
- ◆ A wide variety of types analyses of soil cores can be performed

Essential Information from Cores

- ◆ Geologic and hydrogeologic features
- ◆ Physical, chemical and microbial properties
- ◆ Contaminant mass distributions (high and low K zones)
- ◆ Concentration gradients and diffusive fluxes
- ◆ Effectiveness of remedial technologies

Notes



- ◆ There are many reasons for obtaining, high quality cores, including: an understanding of the detailed microstratigraphy that controls NAPL and solute migration; the provision of samples from which accurate physical, microbial and chemical properties can be determined; a determination of contaminant mass distributions, particularly between high and low K zones and including concentration gradients and contaminant flux between these zones; and finally determining the effects of remedial actions on the subsurface.

Desirable Traits in a Coring Tool

- ◆ 100% recovery and retention
 - Allow the core to enter the core barrel (diameter, cutting shoe)
 - Core must not expand in volume (clays) or fall out (sand)
- ◆ Known depth of origin
- ◆ Minimal disruption of the structure of the strata
- ◆ Retention of pore fluids

The core one sees at the surface should be as accurate a representation of the subsurface conditions as possible

Notes



- ◆ Successful soil coring requires that all the soil from the interval drilled enters the core barrel and does not expand or fall out upon retrieval. In addition, the structure of the medium must not be disturbed and the pore fluids should remain in place. While this list of attributes is quite simple and straightforward, achieving them is not easy in practice.

Minimal Disruption of the Strata 9 x 9 m Cell DNAPL Migration in Aquitard Microbeds



Notes



- ◆ The core in the picture was sampled using a CME continuous core sampler in the Borden Aquitard just outside the 9 X 9 meter experimental cell at Canadian Forces Base Borden. Brewster et al (1995) had conducted an experiment within the double, sealed-joint sheet piling cell in which the cell was instrumented with a dense array of geophysical sensors and then 700 liters of PCE DNAPL was released into the subsurface within the cell. Though the cell was keyed into the clay aquitard, DNAPL escaped through the clay at the base of the cell. Detailed cores of the aquitard, such as that pictured, were essential in locating the DNAPL and cleaning it up. The detail of the micro-stratigraphy in this core is kept intact and fine detail is visible.

Structure and Pore Fluids Intact

9 x 9 m Cell DNAPL Migration in Aquitard Microbeds

Sand microbed



DNAPL (red) migration in sand microbed



Notes



- ◆ The photo to the left shows a thin sand microbed in a core from the aquitard just outside the 9 X 9 meter cell. When the core is divided and the end view of the microbed is observed (right) the PCE DNAPL (dyed red prior to release) is clearly present in the sandy material. This type of information is invaluable, but often goes un-noticed in cores where recovery is poor or the medium undergoes a high degree of disruption.

Retention of Pore Fluids

DNAPL “Pool” vs Residual Mapping in North Haven, CT

PROFILING TECHNIQUES

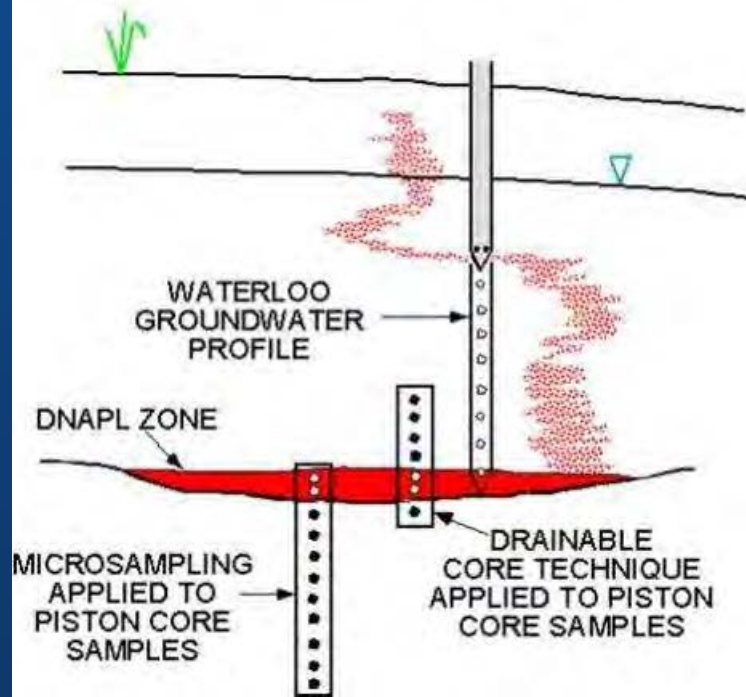

Notes

- ◆ Parker et al. (2004) investigated invasion of chlorinated solvents into an aquitard beneath “pools” of DNAPL in a sandy aquifer at an industrial facility in CT. Basic stratigraphy was defined using a dual casing direct push coring tool known as EnviroCore. However, the pools and the invasion into the aquitard were investigated using a unique direct push piston coring tool developed at the University of Waterloo (Zapico et al., 1987). Using this tool the authors were able to drill holes in the aluminum core tube which was kept vertical (photo on the right) and drain pore fluids from the core. In this manner, the DNAPL saturation at various elevations along the core was mapped. Subsequently, soil subsamples were collected from the core for analysis for VOCS, allowing the DNAPL pool and the diffusive flux of contaminants to be mapped in detail.

Coring Platforms

- ◆ Sonic methods
 - » Very high frequency
- ◆ Direct Push methods
 - » Variable Percussion and downpressure
- ◆ Auger/Rotary Methods
 - » Low frequency percussion



Notes

- ◆ There are essentially three types of coring platforms available to investigators of contaminated sites. The first are sonic or roto-sonic rigs, which rely on very high frequency vibrations to mobilize soil (or rock) particles and allow the casing (or other tools) to move into the medium. This high frequency vibration works very well for rapid penetration of many types of formations, but the vibration also can result in significant disturbance of the core material in many instances. In some formations the sonic frequencies can result in the generation of significant heat which can drive off volatile organic compounds. In some settings significant quantities of water are added to prevent “flowing sands” from heaving into the core barrel during advancement.

Direct push methods use percussion (900 to 1800 blows per minute) and downpressure to advance tools. Typically higher frequencies result in better penetration. Direct push tools/rigs are limited in their ability to penetrate hard formations and may lack the speed of roto-sonic in some formations as well.

Auger or rotary rigs are the oldest of the three and rely on rotational drilling tools such as augers to advance the drill string. These rigs usually produce significant amounts of waste material that requires handling and disposal.

Coring Tools: Single Rod Samplers

- ◆ Single rod tool
- ◆ Entire tool tripped each run
- ◆ May sample “slough” from shallower depths
- ◆ Susceptible to cross contamination
- ◆ Susceptible to “heave” below water
 - Can be used in piston mode



Shelby Tube



Geoprobe MC5 MacroCore



Split Spoon

Notes

- ◆ There are basically three broad categories of coring tools available: single rod samplers; dual casing (or dual tube) samplers, and; piston samplers.

Single rod samplers have been the most commonly employed over the preceding decades and include split spoon samplers used with rotary drill rigs, shelby tubes (typically used to obtain undisturbed samples from clay formations) and tools like the Geoprobe Macrocore tool. The macrocore became probably the most widely used soil coring tool in the late 1990's and the first decade of the 2000's. This tool is very fast and easy to operate. The macrocore tool has a liner in an outer casing with a cutting shoe on it. The tool is driven the length of the core barrel (usually 3 or 5 ft) and then the entire tool is tripped out of the hole, leaving the hole open or unsupported. The tool is then re-deployed and driven to the next sampling depth. This mode of operation allows for material to fall into the hole from the borehole walls above and to be picked up by the sample at the bottom of the hole. It also allows fluids to move within the borehole between runs. Once below the water table the hole typically fills in and the macrocore tool is no longer useful.

Recently the macrocore MC5 tool has been set up to be run as a piston tool as well as a standard single rod sampler. In the center photo, the piston is shown protruding from the cutting shoe and a rod connected to the piston is visible within the liner. In this mode with the piston in place, the tool can be driven to any particular depth, the piston can be withdrawn and a depth discrete sample can be collected including below the water table.

Coring Tools: Dual Tube



- ◆ Outer casing stays in place, core barrel tripped
- ◆ Geoprobe (DT) Sampling System
 - Three system sizes:
 - DT22 (2.25-in x 48-in length) 1.125-inch core
 - DT325 (3.25-in x 48 or 60-in length) 1.85-inch core
 - DT45 (4.5-in x 48 or 60-in length) 3-inch core
- ◆ High quality core
- ◆ Minimal cross contamination
- ◆ Susceptible to “heave” below water table
 - Can be used in piston mode
- ◆ Envirocore no longer commercially available

Notes

- ◆ Dual tube samplers use an outer casing that stays in place in the formation while an inner core barrel and set of rods is tripped in and out. This type of tool prevents the collapse of the borehole walls and inhibits the vertical movement of fluids within the borehole. Dual casing tools are a little slower than the single rod tools for shallow holes, but having a cased hole is often well worth the tradeoff of speed. The tool at the top is an EnviroCore outer casing and core barrel, and is typical of dual casing tools. The EnviroCore system is no longer commercially available. Geoprobe makes three sizes of dual casing tools with a variety of cutting shoes. Dual casing tools can become ineffective in environments with “flowing sands” below the water table. In such situations, either one must add water to prevent the sand heave or switch to a piston tool. The Geoprobe dual casing tools can be used as piston tools with a few additional parts.

Coring Tools: Waterloo Piston Tools

Zapico et al., 1987

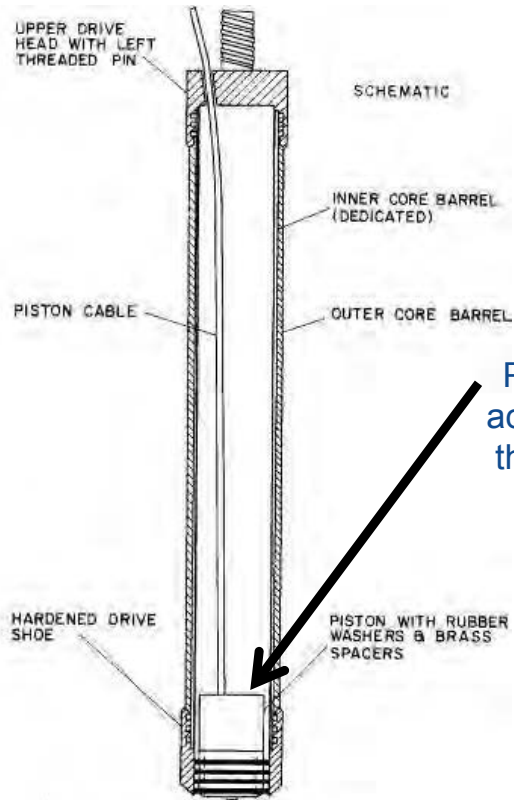

Starr & Ingleton, 1992

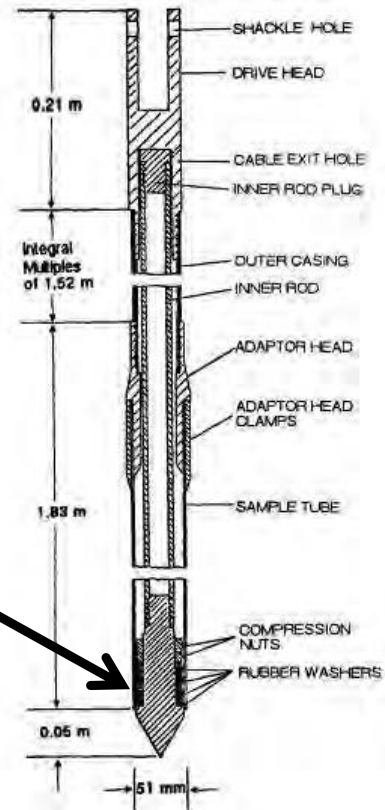

Piston is stationary and acts as a syringe, holding the low cohesion soils in the barrel

Notes

- ◆ Most piston coring tools use the piston simply to keep formation material out of the core barrel during advancement to the target sampling depth. The piston is then either removed, or it is released and allowed to “float” and be displaced by the formation material entering the core barrel.

In the 1980’s a unique type of piston coring tool was developed (Zapico et al, 1987) for sampling “cohesionless sands.” This tool was a response to the common problem of sampled material falling out of the core barrel in loose sand formations. The Waterloo Piston Coring Tool is comprised of an outer casing fitted with a cutting shoe, an inner barrel and core liner through which run a piston and rods. The unique aspect of the Waterloo tool is that the piston is fitted with rubber bushings and brass spacers which fit tightly against the core tube wall. The seal is often enhanced by applying a thin layer of hydrated bentonite to the bushings. The piston is locked in place during driving to the target depth. Once at the target depth the rods attached to the piston are held stationary by a cable fixed to an immobile object on the drill rig. In this way the piston remains stationary in space as the core barrel is advanced downward. The tight fit between the piston and core liner wall (typically an aluminum tube) results in the creation of a suction which holds the sand and pore fluids in place. A modification of the tool without the outer casing was developed by Starr and Ingleton (1992) for use without a drill rig. Since the tool lacks an outer casing, it relies on the integrity of the aluminum sampling tube. In dense or rocky formations the tube is typically ripped or crumpled and coring is prevented. The tool works well in sandy formations.

These tools were manufactured and sold by Solinst LTD of Canada but have been discontinued.

Reference

Zapico, M.M., S. Vales and J.A. Cherry, 1987. A wireline piston core barrel for sampling cohesionless sand and gravel below the water table. *Ground Water Monitoring Review*, Vol. 7. P. 73-87.

Starr, Robert C. and R.A. Ingleton, 1992. A new method for collecting core samples without a drilling rig. *Groundwater Monitoring & Remediation*, Vol. 12 No. 1, P. 91-95.

Freezing Core Downhole to Retain Sample

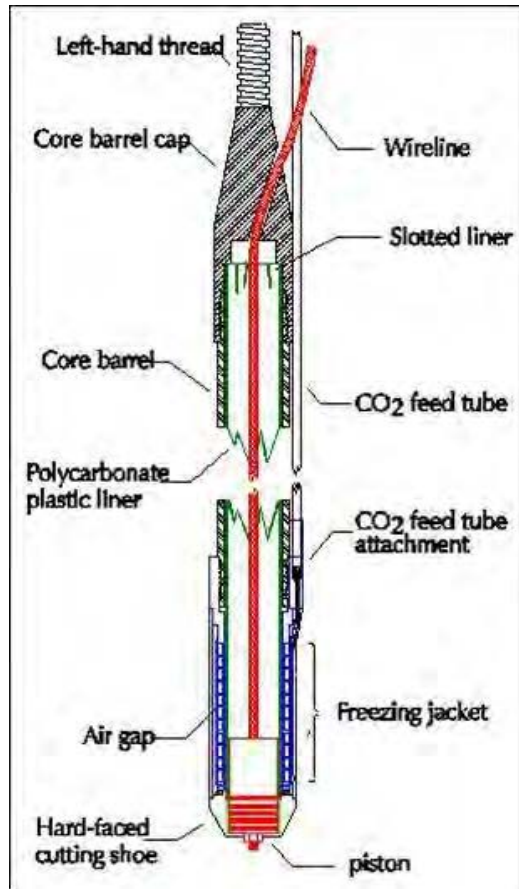

USGS modification of Solinst (Zapico) coring tool
Freezes bottom 3-inches of core



Murphy and Herkelrath, 1996

Notes

- ◆ Several modifications to the Waterloo Piston tools have been documented in the literature. The Kansas Geological Survey experimented with mechanical steel “fingers” at the base of the tool to help retain the sample and later tried an inflatable bladder to hold the sample in place. Neither of these prototypes was every commercialized. The United States Geological Survey worked with a modification of the Waterloo tools in which liquid carbon dioxide was pumped down the outer casing to a specially modified drive shoe. The CO₂ would then freeze the drive shoe and the bottom 3-inches of the core barrel and core which served to keep the sample in place. The USGS used this tool on some of its experimental sites to depths of up to 50 ft. The tool has not been commercialized. Other researchers are currently working on various versions of “cryogenic” coring tools.

Reference

Murphy, Fred, and W.N. Herkelrath, 1996. Ground Water Monitoring and Remediation, Vol. 16 No. 3. P. 86-90.





Continuous cores water table to bedrock 70 – 315 ft bgs

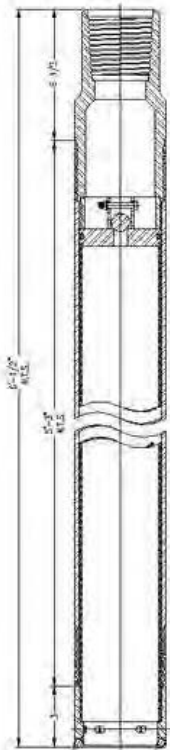

Sonic Coring

MMR – Cape Cod, MA

Split core barrel w/ Lexan liner (5 ft cores)



Notes

- ◆ Sonic drilling has become extremely popular in the environmental remediation industry due to its speed and ability to penetrate almost any formation encountered and to reach greater depths than direct push and auger rigs. Rotasonic also offers large diameter cores and continuous coring. In some formations, the quality of cores collected with sonic rigs is quite good. However in many formations, the energy from the sonic head results in excessive movement of formation material in the core barrel and destruction of the structure of the soil. In many applications, cores are retrieved in 20-ft lengths and then vibrated out of the core barrel into a flexible plastic sleeve. This approach is bad for maintaining structure and keeping pore fluids in place. Alternatively 5 foot core barrels with liners can be used to minimize disturbance. Keeping the core in the core barrel has proven to be problematic in some formations and disruption of formation structure still occurs. In many cases water needs to be added to the casing to prevent flowing sands from entering the barrel. The split core barrel approach was used by researchers from the University of Guelph and Groundwater Science Incorporated to investigate a deep plume at the Massachusetts Military Reservation on Cape Cod.

Sonic Coring Issues

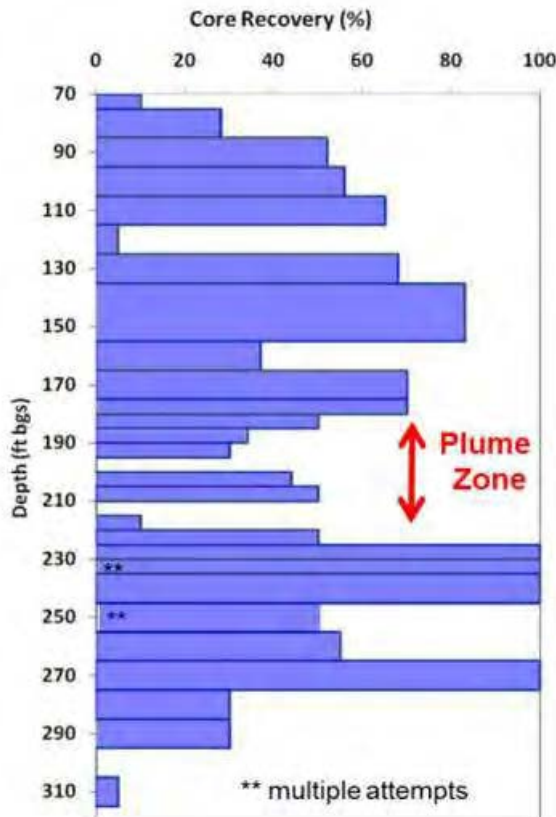

- ◆ Poor recovery
 - flowing sands
- ◆ Heaving conditions
 - water used to minimize effects
 - approx. 4000 gal total (~20 gal/ft)
 - water flushes through cores
 - no check valve
 - significant negative bias for VOCs
- ◆ Core samples highly disturbed
 - limited insight on detailed stratigraphy
 - inadequate for VOC sampling

Notes



- ◆ At the MMR site, the investigators noted that recovery was poor due to the lack of cohesion in the sandy parts of the formation. The plume occupied a transition zone of interbedded materials between the high conductivity sands and a silty aquitard. Recovery was particularly poor in this zone as shown in the recovery plot above. In spite of the use of the 5-ft core barrel and liners, the samples were highly disturbed. In addition, water was used by the drillers to control heave and this resulted in problems with chemical quality samples collected from the cores.

Mass Distribution Via Core Subsampling (limited number of samples collected/analyzed)

Waterloo APS™
ADVANCED PROFILING SYSTEM

Sonic Core

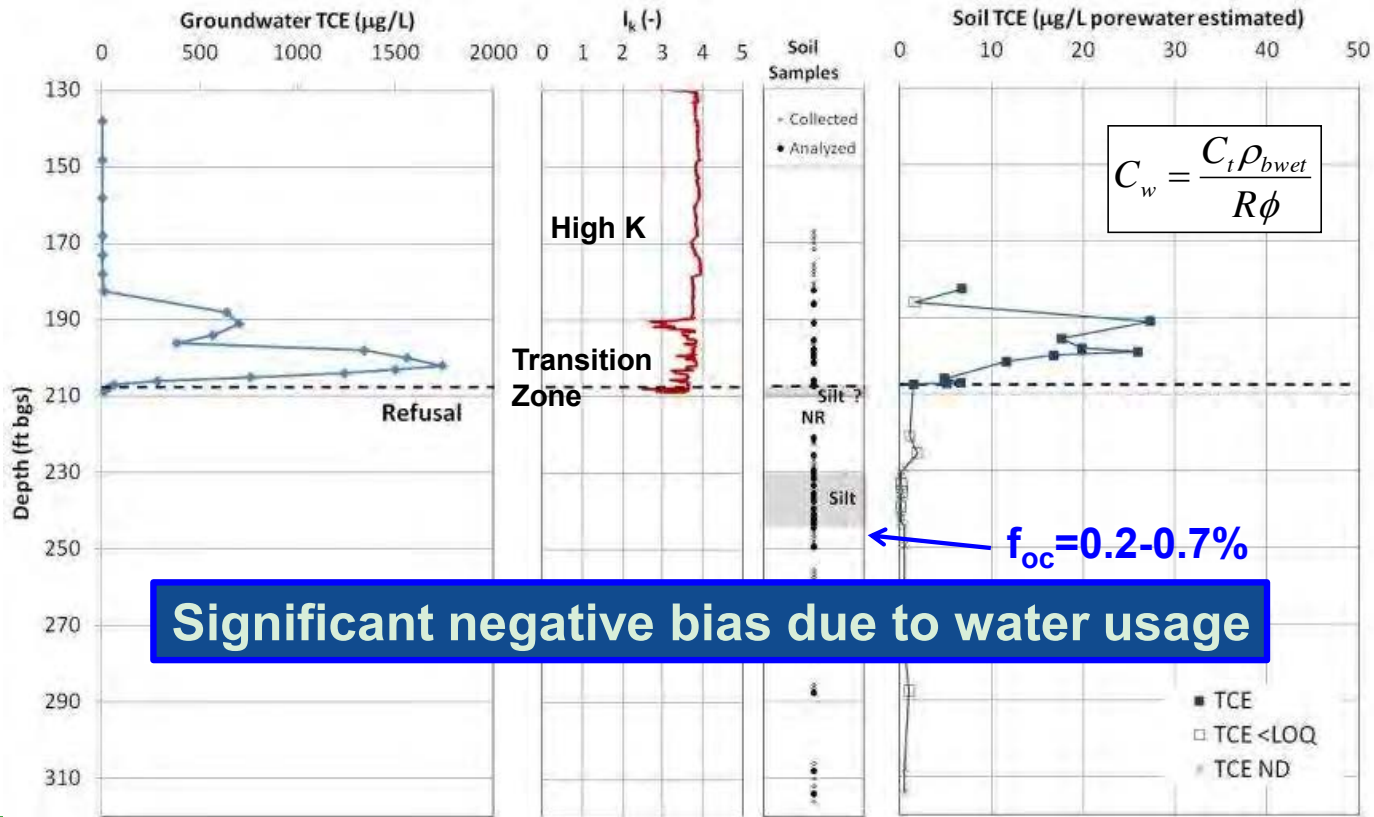

Notes

- ◆ The plot on the left is the concentration of TCE in groundwater samples collected with the Waterloo Advanced Profiling System (Waterloo^{APS}TM) and shows peak concentrations of approximately 1,700 µg/L. The plot immediately to the right of this plot shows the index of hydraulic conductivity of the formation obtained with the Waterloo^{APS} showing the transition zone in which the plume resides. The plot on the right shows the pore water concentrations calculated from soil samples obtained with the sonic coring tool. These concentrations range only as high as 30 µg/L, nearly 2 orders of magnitude lower than the actual groundwater concentrations, as a result of the use of water for drilling and the movement of pore fluids in the core.

Hydrostratigraphic Tools



23rd Annual NARPM Training Program

3-23

Cone Penetrometer Technology (CPT)

- ◆ Continuous stratigraphic profiling
 - Can be combined with numerous direct sensing devices (such as LIF, MIP, TarGOST, raman spectroscopy)
- ◆ Describes stratigraphy on the basis of strain gauge ratios
- ◆ Real-time data generation
- ◆ Static push only

Notes

- ◆ Cone Penetrometer Technology (CPT) systems are generally the larger of the two direct-push platforms. Unlike a percussion hammer system, CPT systems use a static reaction force to advance steel rods and either a sampler or analytical device. The static reaction force generally is equal to the weight of the truck, which is supplemented with steel weights or with smaller rigs in-ground anchors. CPT systems that weigh 20 tons are common.

A variety of samplers for retrieving soil, soil gas and groundwater samples are used with CPT systems. Geotechnical sensors employed with a CPT system include sleeve-friction and tip-resistance sensors that map soil texture. Chemical sensors as well as downhole desorption or sampling techniques have been developed to detect, delineate and monitor sites contaminated with petroleum products, volatile organic compounds (VOCs), metals and explosives.

Geotechnical sensors provide a rapid, reliable and economical means of determining soil behavior types which can be related to soil stratigraphy, relative density and strength. Hydrogeologic conditions such as hydraulic conductivity, static and dynamic pore pressure, and soil and water conductivity can also be collected.

Source: <http://www.clu-in.org/characterization/technologies/dpp.cfm>

Internet

For more information on CPTs, see EPA Contaminated Site Clean-Up Information (CLU-IN) online technology resource (<http://www.clu-in.org/characterization/technologies/dpp.cfm>)

Cone Penetrometers

- ◆ Static push (no percussion or vibration)
- ◆ Large heavy trucks
- ◆ Real-time data from *in situ* sensors
- ◆ Variety of sensors

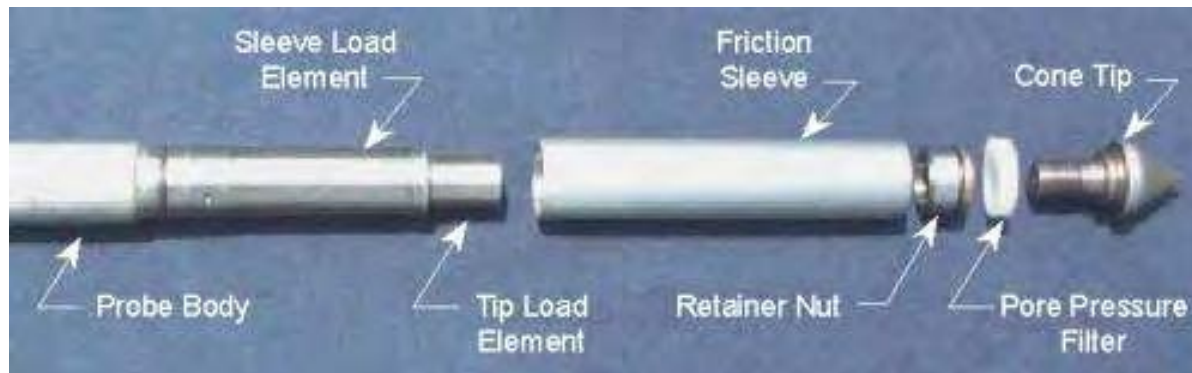

Notes

- ◆ The principle behind CPT is fairly straightforward. A hydraulic ram is used to push the penetrometer tip and push rods into the subsurface, often to depths in excess of 100 feet below ground surface (bgs). The depth of penetration is limited by the structure of the subsurface formation. The technology can be used only in unconsolidated material. Hard layers, partially cemented sediments, and rocks and boulders limit penetration.

A variety of samplers are carried in the CPT truck. Geotechnical sensors and analytical instruments may also be included in the system. These instruments are attached to data acquisition systems inside the CPT truck by data cables inside of the probe rods, allowing acquisition and analysis of data to be conducted within an enclosed, protected work space.

Data from Piezocone from ARA

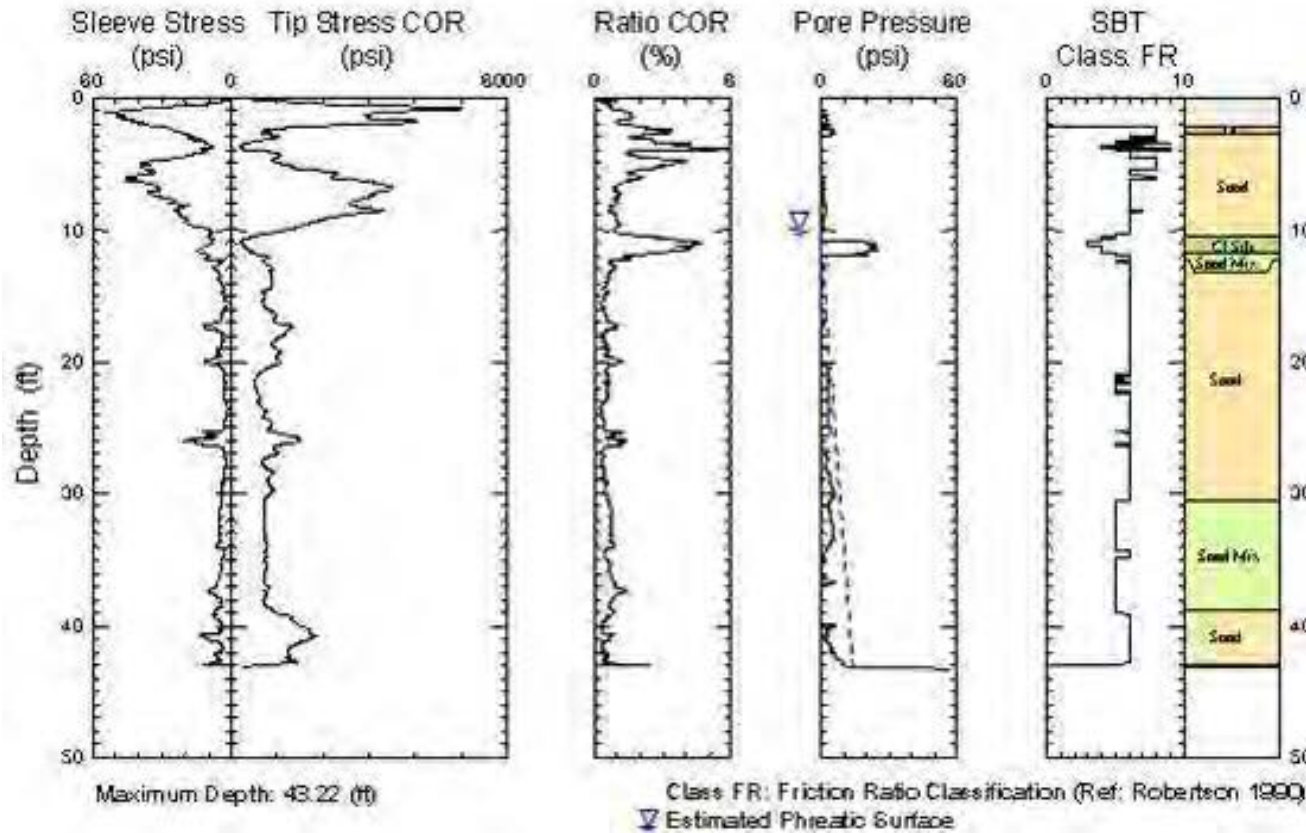

Notes

- ◆ Cone penetrometers use two strain gauges, one on the tip of the tool and the other around the circumference or sleeve) of the tool. The ratio of the tip strain to the sleeve strain is compared to a “soil behavior type (sbt) which relates the strain results to a soil type. Thus CPT uses mechanical analogs to estimate the stratigraphy.

Reference

Gregg Drilling & Testing, Inc., <http://www.greggdrilling.com>



Geoprobe Hydraulic Profiling Tool (HPT)

- ◆ Continuous hydrostratigraphic data profiling
- ◆ Describes hydrostratigraphy on the basis of the flow of water into the formation
- ◆ Real-time data generation
- ◆ Direct push (percussion and vibration or static push)

Notes

- ◆ The Hydraulic Profiling Tool (HPT) by Geoprobe provides continuous real-time profiles of soil hydraulic properties for both fine and coarse-grained matrices. The HPT uses a sensitive, downhole transducer to measure the pressure of the soil to injection of water.

HPT can be used to:

- » Locate and define preferential migration pathways for contaminants in the subsurface
- » Target zones for injection of remediation material
- » Select well screen intervals
- » Evaluate locations to conduct slug tests
- » Measure static water conditions throughout a site

Source: <http://www.clu-in.org/characterization/technologies/dpgeotech.cfm>



The diagram illustrates the components of a High Pressure Test (HPT) probe. It features a main probe with a black handle and a metal body. A red dashed arrow points from the main probe to a close-up inset of the metal body, which shows an 'Injection Screen' and an 'E-log Wenner Array'. A black bracket on the main probe points to the 'E-log Wenner Array'. An inset image shows a coiled orange 'Trunkline' cable with a black connector. The text 'HPT Components' is prominently displayed, with 'Courtesy of Geoprobe Systems' below it.

Trunkline

E-log Wenner Array

Injection Screen

HPT Components

Courtesy of Geoprobe Systems

Notes



- ◆ Water is pumped through a tube in the trunk-line and is injected into the formation from the screen. An in-line pressure transducer measures the formation pressure response.

HPT Set Up



Field Computer

HPT Controller

HPT Pump

Notes



- ◆ The field computer monitors depth from the string pot, and the signal from pressure transducer and e-log array. The controller regulates water flow rate and line pressure.

Comparison of Logs

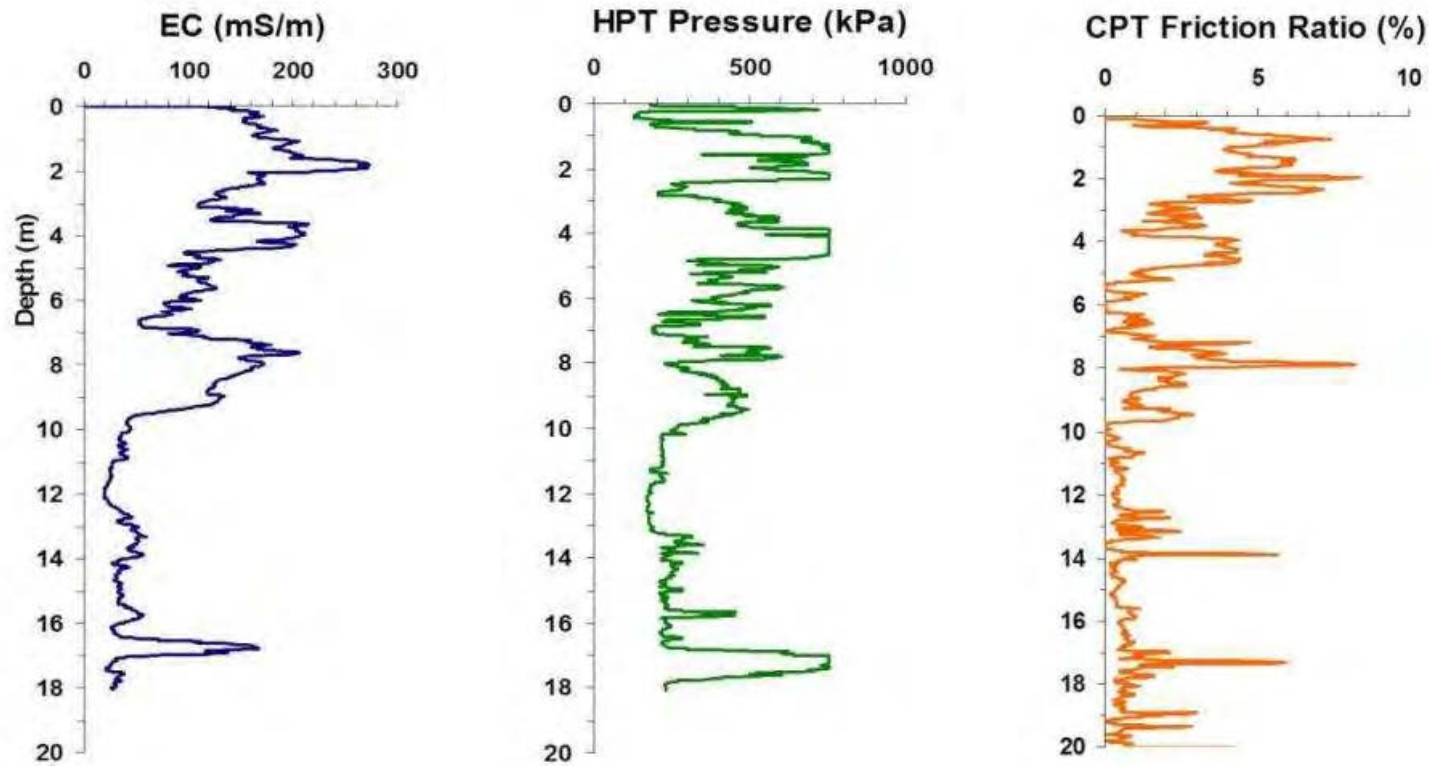

Notes

- ◆ This slide shows three different types of logs from the same location: on the left is an electrical conductivity log, in the middle and HPT pressure log and on the right a friction ratio log from a CPT probe. At this location, the three methods show good agreement. At about 2 meters a high in the electrical conductivity indicates a fine grain size unit. This fine grain size unit is confirmed with the high pressure on the HPT log. The low permeability layer at 2 meters is less clear on the CPT friction ratio log. Typically clays are characterized by low FR (e.g., 3 or 4) clays and silts around 5 – 7 and sands or silty sands by FRs of 8 – 11.

Waterloo APS™

ADVANCED PROFILING SYSTEM

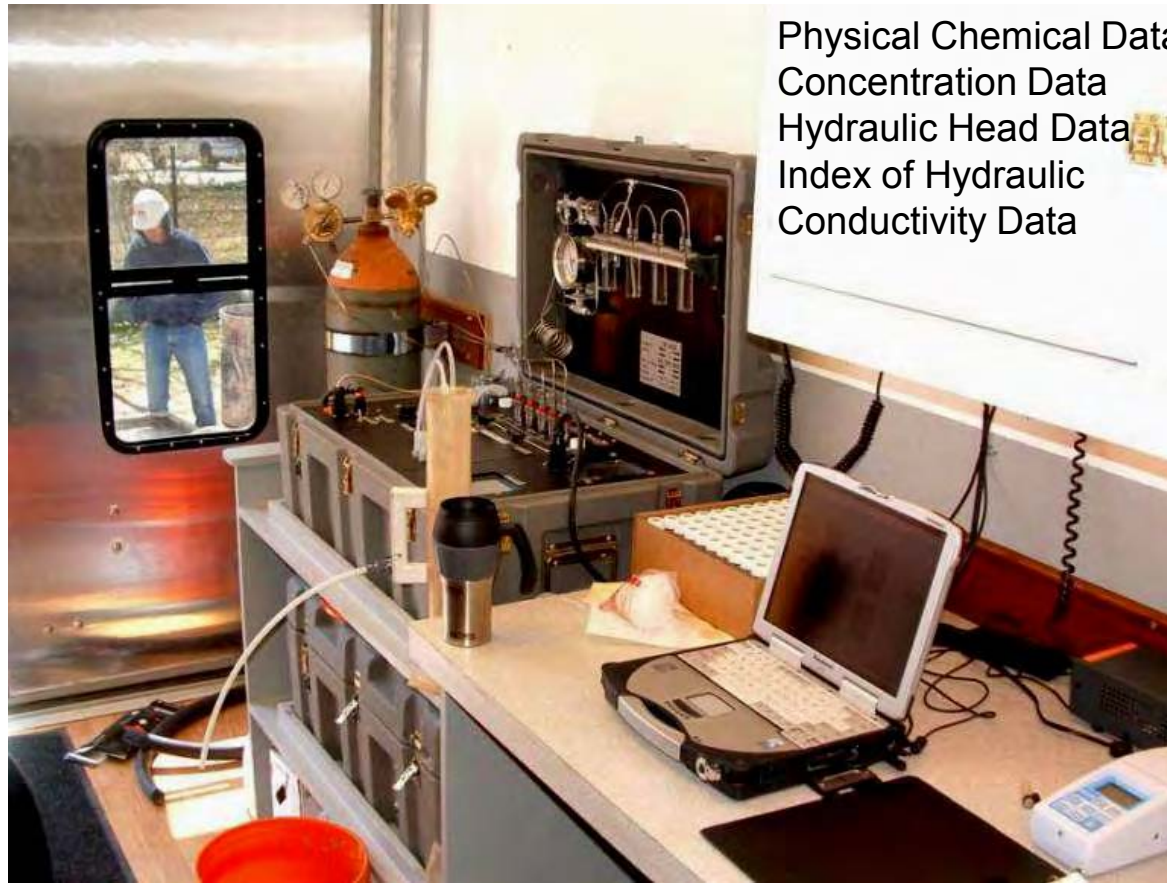

Physical Chemical Data
Concentration Data
Hydraulic Head Data
Index of Hydraulic
Conductivity Data

Notes



- ◆ The Waterloo Advanced Profiling System also collects real-time hydrostratigraphic data. The Waterloo APS will be discussed shortly.

Borehole Flowmeters

- ◆ Require existing wells
- ◆ May require use of packers
- ◆ Pumping during logging and waste handling required
- ◆ Affected by well construction (skin effects)
- ◆ Data analysis relatively complicated

(continued)

Notes



- ◆ Borehole flow meters can provide valuable information on the distribution of hydraulic conductivity along a borehole. However, there are significant limitations to the use of borehole flowmeters including those listed here.

Borehole Flowmeters

Impeller



Heat Pulse



Electromagnetic



See: <http://water.usgs.gov/ogw/bgas/flowmeter/>

Notes

- ◆ There are three main types of borehole flowmeters: impeller (also known as spinner flow meters); heat pulse and; electromagnetic. Impeller and electromagnetic types of flowmeters can be used in either trolling (moving vertically up or down the well bore) or in stationary mode. The heat pulse flowmeter can only be used in stationary mode. In trolling, the flowmeter is advanced up or down the borehole at a constant speed while measurements are made. In stationary mode, the flowmeter is stopped at a series of depths in the borehole and measurements are made while the device is still. The impeller flow meters cannot resolve flow rates as low as the EM and HP types.

All flowmeter approaches require pre-existing wells which must fully penetrate the portion of the flow system of interest.

Ideally, flow meter logging is done under ambient (natural flow) conditions and under pumped conditions. Pumping obviously creates waste management issues in contaminant plumes. As the pumping rates needed are not typically very high, the pumping is unlikely to cause significant plume shifting or NAPL remobilization issues but care should be taken on a site specific basis.

Borehole Flowmeter K Profile

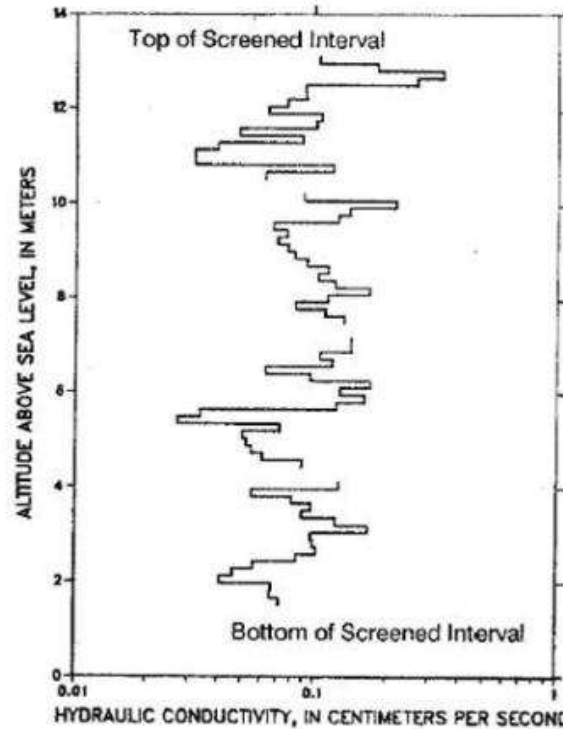

Hydraulic conductivity profile in a single borehole at Cape Cod (Hess, K.M. USGS)

Figure 3.--Typical vertical profile of horizontal hydraulic conductivity obtained from a flowmeter test in a long-screened well.

Notes



- ◆ This figure shows the wide variability of hydraulic conductivity across a single borehole.

Effects of Well Construction

Significant differences in borehole flowmeter K resulting from nature of well construction at Columbus AFB

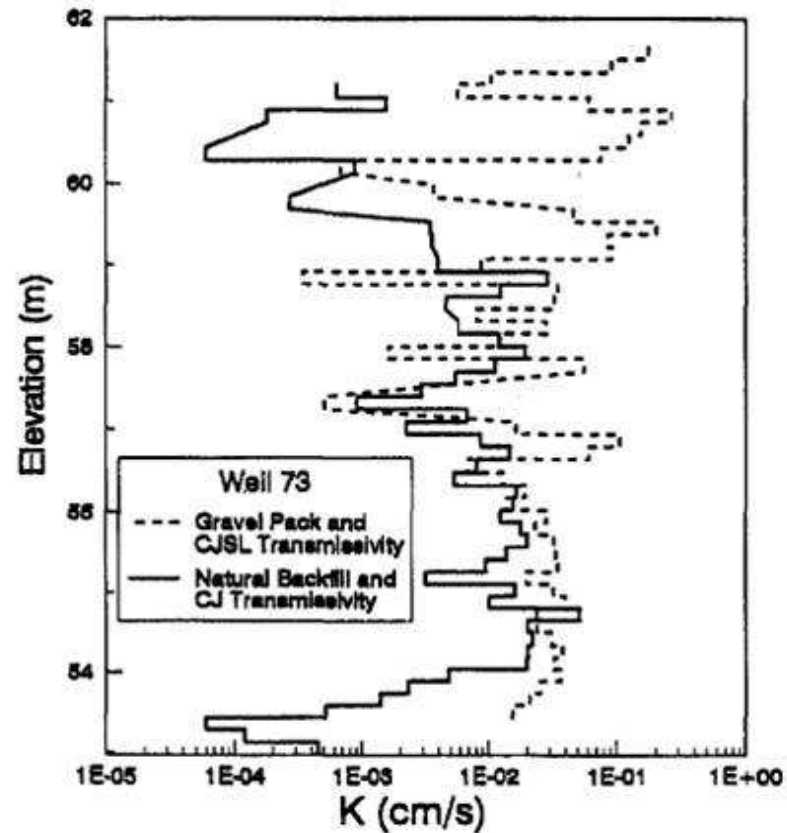

Young, Steve 1998. Groundwater, Vol. 36, No. 1 pp. 67-75

Notes

- ◆ Young (1995, 1998) describes using flowmeters in cased and screened wells in heterogeneous unconsolidated deposits at Columbus Air Force Base. He concludes that flowmeter testing can yield high resolution and reliable data on the distribution of hydraulic conductivity. However, he warns of potentially significant problems arising from skin effects in the wells. It is necessary to know the construction of the wells and to have well developed screened intervals.

Reference

Young, Steven C., 1995. Characterization of High K Pathways by Borehole Flowmeter and Tracer Tests. *Groundwater* Vol. 33 No. 2.

Young, Steven C., 1998. Impacts of Positive Skin Effects on Borehole Flowmeter Tests in a Heterogeneous Granular Aquifer. *Groundwater* Vol. 36. No. 1.

Qualitative Tools for Contaminants

MIP Schematic

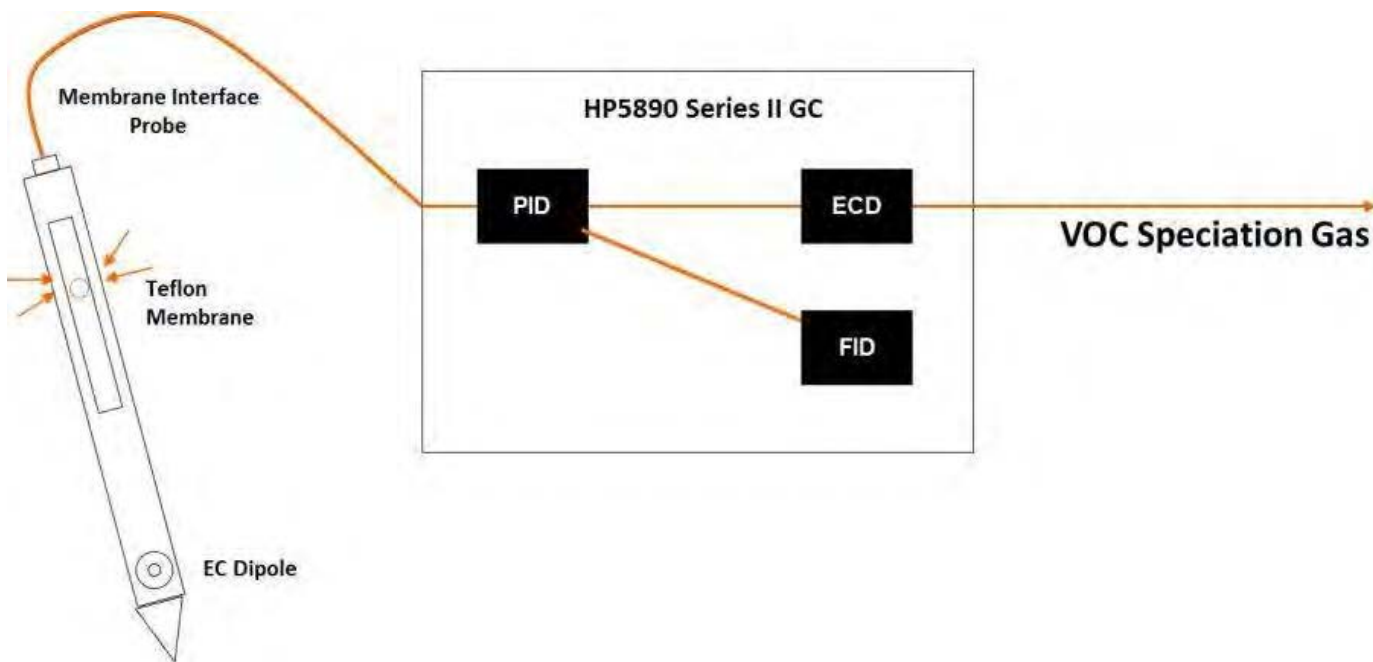

Notes

- ◆ Membrane Interface Probes (MIP) is a semi-quantitative, field-screening device that is capable of sampling volatile organic compounds and some semi-volatile organic compounds from subsurface soil in the vadose and saturated zones. It is typically used to characterize hydrocarbon or solvent contamination. Its ability to rapidly locate and identify contaminants reduces uncertainty in management decisions associated with costly cleanup projects, such as those commonly involving source zones of dense non-aqueous phase liquid (DNAPL) and light non-aqueous phase liquid (LNAPL).

The probe captures the vapor sample, and a carrier gas transports the sample to the surface for analysis by a variety of field or laboratory analytical methods. Additional sensors may be added to the probe to facilitate soil logging and identify contaminant concentrations. The results produced by a MIP at any location are relative and subject to analytic verification.

Internet

For more information on MIPs, see EPA Contaminated Site Clean-Up Information (CLU-IN) online technology resource (<http://www.clu-in.org/characterization/technologies/mip.cfm>)

MIP in Action



Notes



- ◆ The MIP is used in conjunction with a direct push platform (DPP), such as a cone penetrometer testing (CPT) rig or a rig that uses a hydraulic or pneumatic hammer to drive the MIP to the depth of interest to collect samples of vaporized compounds.

MIP technology uses heat to volatilize and mobilize contaminants for sampling. Heating the soil or groundwater adjacent to the MIP's semi-permeable membrane, volatilizes the VOCs, which then pass through the probe's membrane and into a carrier gas for transportation to the ground surface.

MIP Strengths and Limitations

◆ Strengths

- Vertically continuous, real-time data on VOC distributions and soil electrical conductivity
- Can typically complete 150 to 250 linear feet of exploration per day
- Ideal for locating source areas and plume cores

◆ Limitations

- “Delicate” instrumentation and limited depth penetration
- Units (volts) not the same as with soil or water concentration
- Correlations with soil and water concentrations problematic
- Generally does not distinguish between analytes
- Apparent “dragdown” of contamination

Notes

- ◆ MIPs may be used to produce reliable estimates of the contaminated mass, which is crucial to achieving cost-effective cleanups.

MIPs provide screening level data that need to be supplemented with analytical soil or groundwater data to fully support human health risk assessments or remediation decisions. Determining the depth at which the sample was taken when the sampler is in a near-continuous operating mode and the push rate is variable can be difficult. Compounds may be found in the subsurface for which the detectors were not calibrated. As with all direct push devices, MIP is only useful for deployment in unconsolidated matrices.

Source: <http://www.clu-in.org/characterization/technologies/mip.cfm> (page 1)

Recent Study Confirms MIP is Only a Qualitative Screening Tool

- ◆ MIP works well for rapid location of relative high concentration zones such as plume cores or source areas
- ◆ MIP does not work well for estimating contaminant concentration or mass

Groundwater

Membrane Interface Probe Protocol for Contaminants in Low-Permeability Zones

by David T. Adamson¹, Steven Chapman², Nicholas Mahler³, Charles Newell³, Beth Parker², Seth Pitkin⁴, Michael Rossi⁴, and Mike Singletary⁵

Abstract

Accurate characterization of contaminant mass in zones of low hydraulic conductivity (low k) is essential for site management because this difficult-to-treat mass can be a long-term secondary source. This study developed a protocol for the membrane interface probe (MIP) as a low-cost, rapid data-acquisition tool for qualitatively evaluating the location and relative distribution of mass in low-k zones. MIP operating parameters were varied systematically at high and low concentration locations at a contaminated site to evaluate the impact of the parameters on data quality relative to a detailed adjacent profile of soil concentrations. Evaluation of the relative location of maximum concentrations and the shape of the MIP vs. soil profiles led to a standard operating procedure (SOP) for the MIP to delineate contamination in low-k zones. This includes recommendations for: (1) preferred detector (ECD for low concentration zones, PID or ECD for higher concentration zones); (2) combining downlogged and uplogged data to reduce carryover; and (3) higher carrier gas flow rate in high concentration zones. Linear regression indicated scatter in all MIP-to-soil comparisons, including R² values using the SOP of 0.32 in the low concentration boring and 0.49 in the high concentration boring. In contrast, a control dataset with soil-to-soil correlations from borings 1-m apart exhibited an R² of ≥0.88, highlighting the uncertainty in predicting soil concentrations using MIP data. This study demonstrates that the MIP provides lower-precision contaminant distribution and heterogeneity data compared to more intensive high-resolution characterization methods. This is consistent with its use as a complementary screening tool.

Notes

- ◆ This paper, published in the journal *Groundwater*, is focused on optimization of the MIP to identify the presence of contaminant mass in low K zones for assessing the effects of matrix diffusion at porous media sites. However, the authors also present data on the nature of correlations of MIP data with definitive data such as detailed soil core subsampling and analysis. Many MIP users maximize the use of the MIP due to its speed and the continuous nature of the data produced. Often this use is accompanied by collection of only small amounts of definitive data and the users create a correlation relationship between the MIP data and the definitive data and then essentially attempt to convert the MIP screening data to actual concentration data. The assessment of the nature of the correlations between MIP and hard data presented in this paper are the latest in a series of such studies that show that quantitative correlations (e.g., linear regressions) between MIP and soil data are very weak. MIP users should avoid relying on MIP screening data in this way.

Analytical Results from 2 Adjacent Soil Cores: Good Correlation

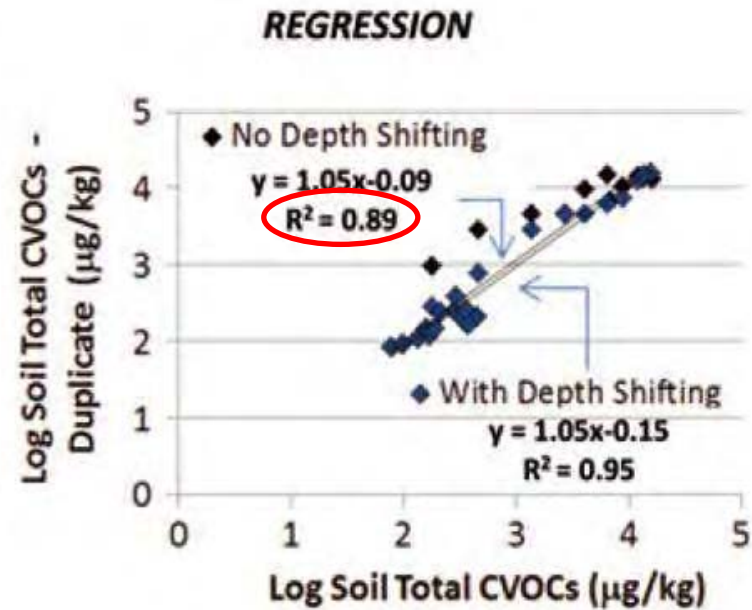
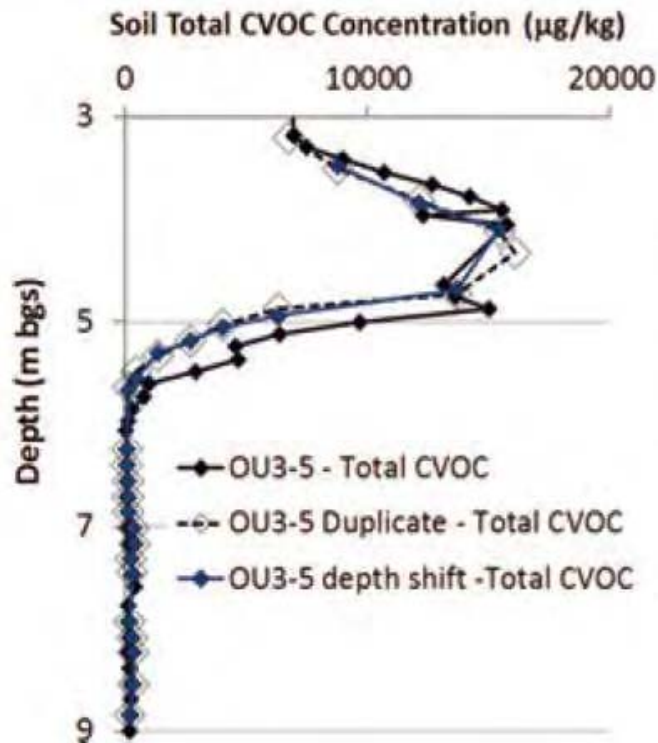

Adamson et al., 2013

Notes

- ◆ At one of the sites at NAS Jacksonville, two soil cores were obtained at adjacent locations. The cores were sampled on a close vertical spacing, placed directly into methanol and samples were analyzed by GC/MS. The figure on the left shows the profiles of total chlorinated volatile organic compounds on the two cores. The profiles show a contaminant peak at about 4 meters bgs. The figure on the right shows a linear regression correlation plot of the two cores. The R squared value for the regression is 0.89, indicating a strong correlation for concentration at two adjacent locations.

MIP and Soil Core High Conc. Location: Reasonably Good ID of Plume Location – Poor Concentration Correlation

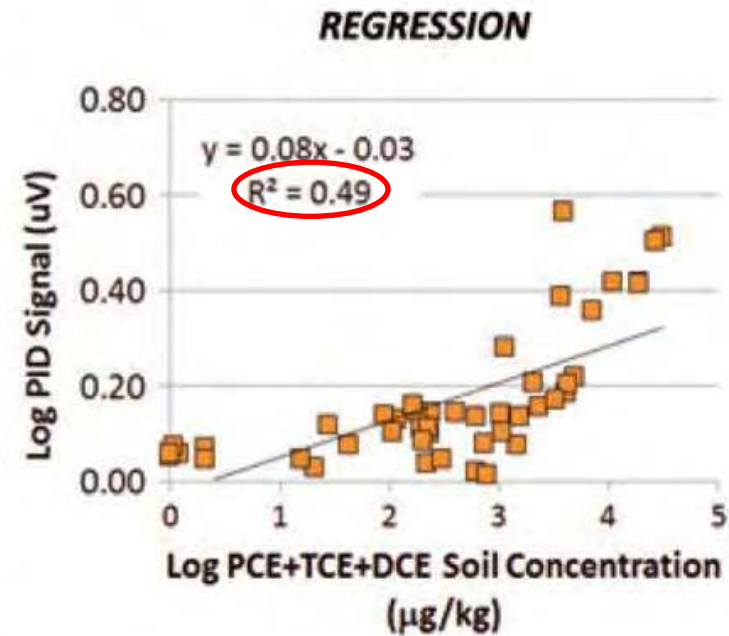
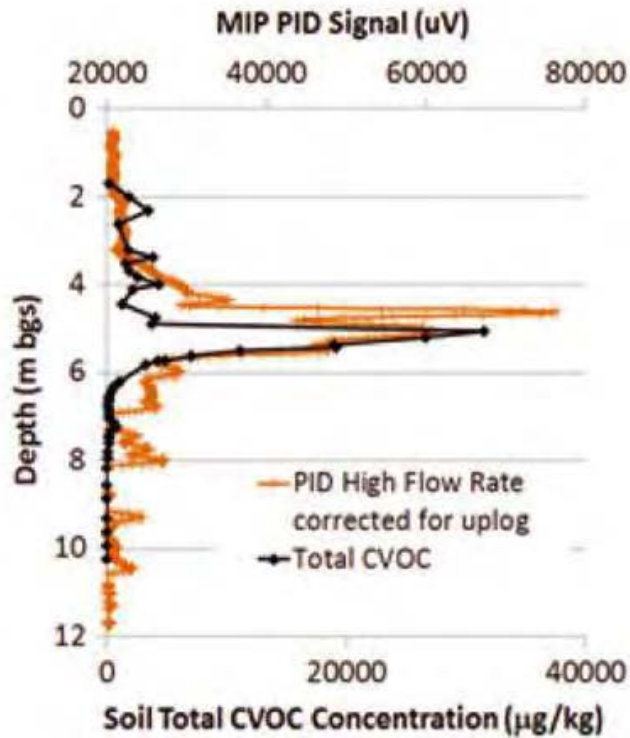

Adamson et al., 2013

Notes



- ◆ Here we compare a soil core profile of total CVOC with a MIP detector (PID) response at adjacent locations. We know from the previous slide that adjacent locations correlate quite well in terms of soil concentration. On the left we overlay the soil profile with the MIP profile and find that they both indicate a sharp peak between 4 and 6 meters bgs. However, when we look at the linear regression between the MIP and the soil profile we see that the R squared is quite low indicating a poor correlation. The MIP works well at identifying the approximate spatial location of a relative hot spot but the data cannot be used to estimate actual concentrations.

MIP and Soil Core Low Conc. Location: Reasonably Good ID of Plume Location – Poor Connection Correlation

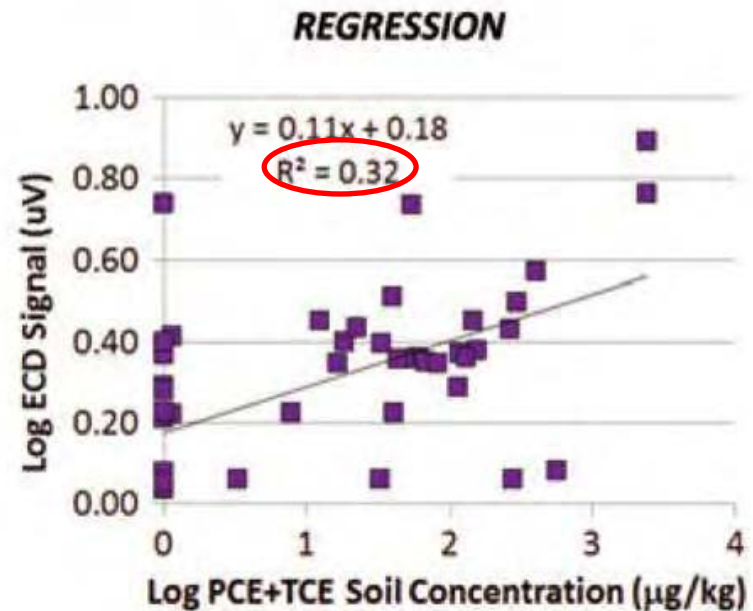
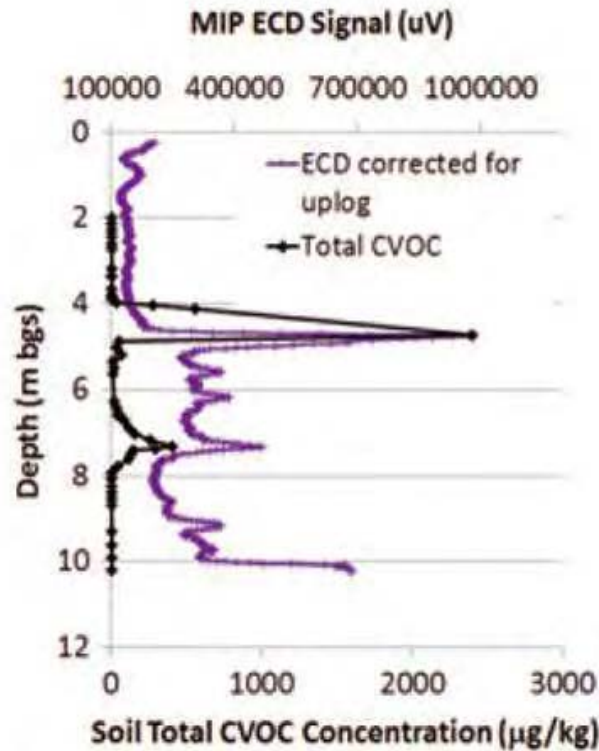

Adamson et al., 2013

Notes

- ◆ This slide shows comparisons of MIP (ECD response) and soil concentration profiles at another site at NAS Jacksonville with lower concentrations than the first one. Again, on the left we see that MIP and the soil profile both indicate a zone of relatively high concentrations between 4 and 6 meters bgs and another smaller one near 7 meters bgs. However, the correlation plot on the right shows that the actual correlations between MIP data and soil concentrations are poor as defined by an R squared of 0.32. The MIP and soil results are really not quantitatively correlative.

Variability in Detector Response

MIP RESPONSE TESTING
TCE and PCE by MIP/ECD

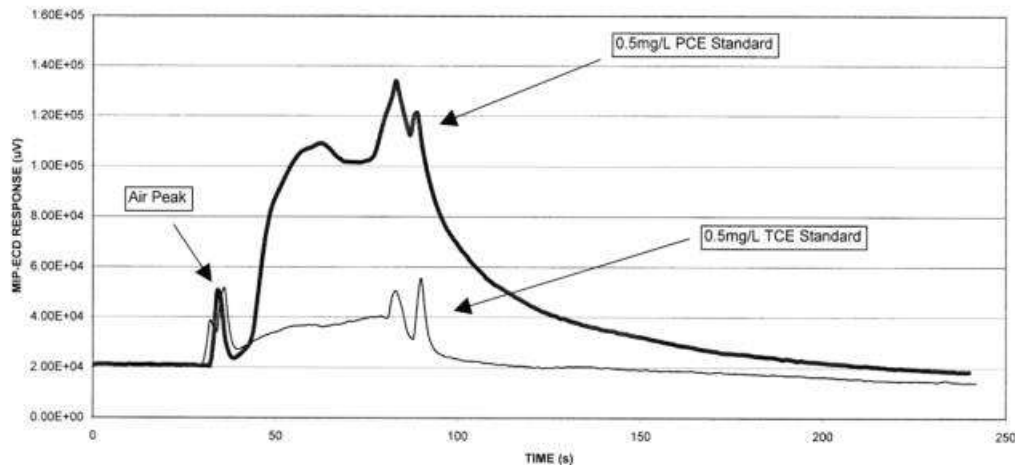

Response Test Results: ECD & PID with PCE, TCE and c-DCE

Compound	ECD Response, mV	PID Response, mV
PCE	1800	16
TCE	690	23
C-DCE	22	19

Annotations: A downward arrow between PCE and TCE ECD responses is labeled 'Dramatic Decrease'. A vertical label 'No Significant Change' is positioned between the PID responses for TCE and C-DCE.

Notes

- ◆ The ECD is the most sensitive detector for chlorinated compounds used in MIP logging. One limitation of the ECD is that the sensitivity of the detector to specific compounds varies strongly with the number of chlorine atoms on the molecule. Approximately an order of magnitude of signal is lost with each chlorine atom. In the plot above the response test curves are shown for 0.5 mg/L PCE and TCE standards. The response of the 0.5 mg/L PCE standard (upper curve) is much stronger than that for the TCE standard (lower curve). Thus, if the makeup of the plume changes spatially (i.e., the ratio of PCE:TCE changes), then the detector response will change significantly even if the overall mass per volume concentration is the same. The travel time for the two compounds is the same.

Factors Impacting MIP Performance

Trip Time Disparity

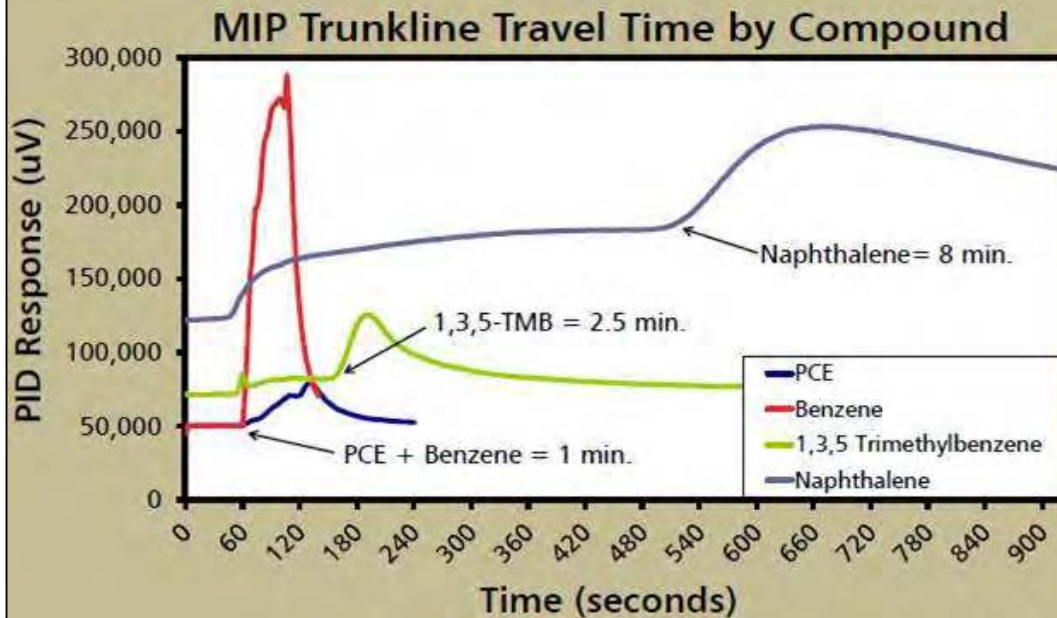

- Different compounds travel at different rates, causing potential inaccuracies in contaminant distribution

Notes

- ◆ In the last slide we saw that the travel time (from membrane, through the trunkline to the detector) was the same for PCE and TCE. However, for more dissimilar compounds, the travel times can be very different. The plot above shows the travel times for PCE; benzene; 1,3,5-TMB; and naphthalene. The travel times vary from 1 minute for PCE and benzene to 8 minutes for naphthalene. Since the depth at which the contamination was encountered is determined in the MIP software on the basis of a single travel time based on a response test, the presence of multiple compounds with different travel times will result in peaks showing up at different depths, when, in fact they all originated at the same depth.

Correlations and Complex Mixtures

Trip Time Disparity

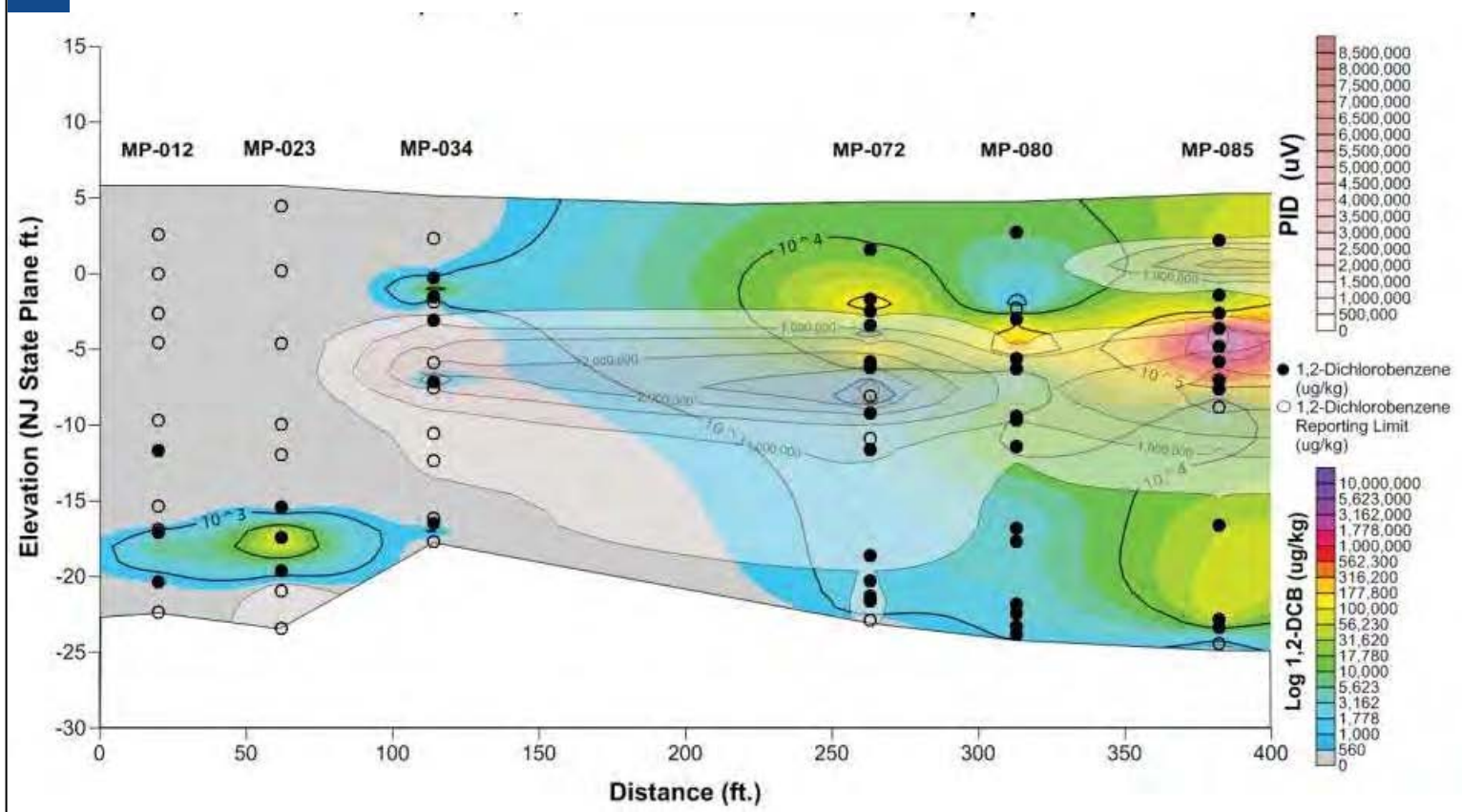

Notes

- ◆ This image is from a transect at a chemical plant in New Jersey. The colored image represents 1,2-dichlorobenzene concentrations in soil with each black dot showing the location of a soil sample. The ghosted image shows the MIP PID response (in micro volts). It is clear that the zones at which the MIP shows peak concentrations are shifted downward relative to the locations of those peak zones as determined by soil sampling. This downward shift is the result of the long travel times of 1,2-DCB relative to the travel times determined during the response test using TCE. In sites with complex mixtures of contaminants, the MIP data may be hard to decipher and can cause some confusion.

Laser Induced Fluorescence (LIF) – Basics of Optical Screening Tools

- ◆ Work for Aromatic Compounds (PAH)
- ◆ Detect NAPL
- ◆ Employ sapphire-windows
- ◆ Direct push
- ◆ Log of depth vs. fluorescence

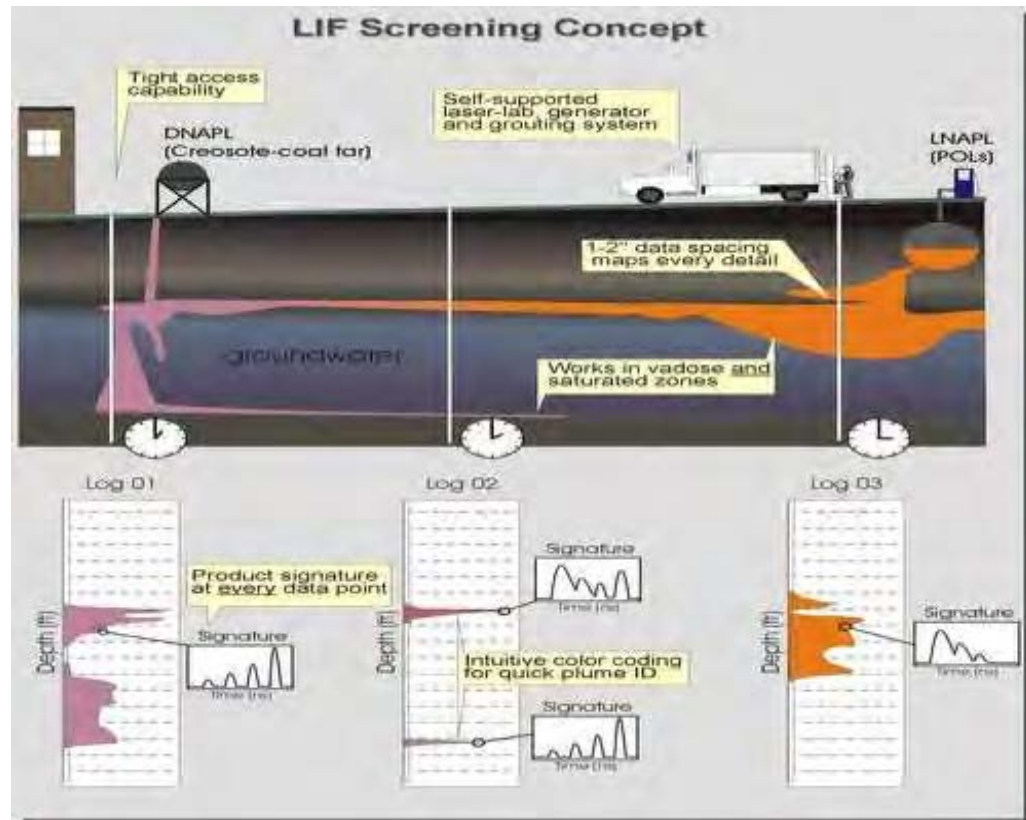

Dakota Technologies, Inc.

Notes

- ◆ Laser-induced fluorescence (LIF) is a method for real-time, in situ field screening of residual and non-aqueous phase hydrocarbons in undisturbed vadose, capillary fringe and saturated subsurface soils and groundwater.

The technology is intended to provide highly detailed, qualitative to semiquantitative information about the distribution of subsurface petroleum contamination containing polycyclic aromatic hydrocarbons (PAHs). Currently available LIF equipment is not designed to detect dissolved-phase contaminants.

LIF instruments provide a relatively fast method for profiling the presence of compounds containing aromatic hydrocarbons in the subsurface. They are especially good at showing the relative concentrations of these compounds with depth so that cleanup activities can be better focused. These technologies do not provide specific contaminant concentrations and cannot be used in subsurfaces that are not amenable to direct push technologies. The instruments do have different compound detection capabilities and it is important for the user to pick the instrument best suited for the aromatic composition of the target compound.

Source: <http://www.clu-in.org/characterization/technologies/lif.cfm> (page 1)

Internet

For more information on MIPs, see EPA Contaminated Site Clean-Up Information (CLU-IN) online technology resource (<http://www.clu-in.org/characterization/technologies/lif.cfm>)

Ultraviolet Optical Screening Tool (UVOST)



Wavelength/time matrix (WTM)

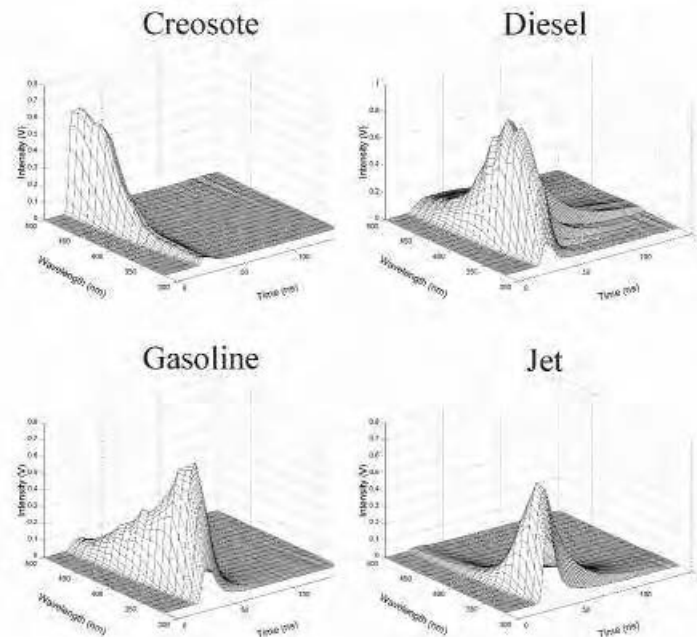

LIF – UVOST and TARGOST

- ◆ Ultra Violet Optical Screening Tools (UVOST)
 - Gasoline, diesel, jet (kerosene), motor oil, cutting fluids and hydraulic fluid
 - Does not see PCBs and straight chain halogenated compounds
 - Can give product class information though use of waveform evaluations
 - 10-500 ppm DLs - From “sheen to neat” - Cannot see dissolved phase PAHs
 - Best for use where presence of NAPL is driver for investigation
 - Matrix effects from soil particle size and color and other things that might be found in soils (sea shells, peat, calcite and calcareous sands)
- ◆ Tar Specific Green Optical TARGOST
 - Coal tar (MGP waste) and creosote and pentachlorophenol (wood treatment)



- ◆ Ultra Violet Optical Screening Tool (UVOST) readily detects gasoline (highly weathered or aviation gas yield is very low to zero), diesel, jet (kerosene), motor oils, cutting fluids, hydraulic fluid, light crude oils and fuel oils. Because of self-quenching, intersystem crossing, photon cycling, UVOST will rarely detect creosote/pentachlorophenol, coal tars and bunker fuel. It does not detect monoaromatics, polychlorinated biphenyls, chlorinated alkenes and alkanes, or explosives.

Matrix effects: the smaller the grain sizes (smaller pore throats) can serve to hide the available NAPL and the darker soils can act as sink for fluorescence.

Tar Specific Green Optical Screening Tool (TarGOST) detects manufactured gas plant coal tars, creosotes, pentachlorophenols and bunker C. It performs poorly in detecting fuels and oils that contain predominately small PAHs. It does not detect monoaromatics, polychlorinated biphenyls, chlorinated alkenes and alkanes, or explosives.

LIF instruments provide a relatively fast method for profiling the presence of compounds containing aromatic hydrocarbons in the subsurface. They are especially good at showing the relative concentrations of these compounds with depth so that cleanup activities can be better focused. These technologies do not provide specific contaminant concentrations and cannot be used in subsurfaces that are not amenable to direct push technologies. The instruments do have different compound detection capabilities and it is important for the user to pick the instrument best suited for the aromatic composition of the target compound. The advantages and limitations of the various technologies are given in the table below.

	ROST	SCAPS	TARGOST	UV LED	UVOST
Advantages					
Abandonment	The sample holes can be grouted as the push rod is pulled from the hole.	The sample holes can be grouted as the push rod is pulled from the hole.		If a CPT is used, the sample holes can be grouted as the push rod is pulled from the hole.	
Accessibility			When mounted on a direct push (DP) platform (non-CPT) can access tight areas and operate inside buildings.	When mounted on a direct push (DP) platform (non-CPT) can access tight areas and operate inside buildings.	When mounted on a direct push (DP) platform (non-CPT) can access tight areas and operate inside buildings.

	ROST	SCAPS	TARGOST	UV LED	UVOST
3-D Data	Data are compatible with 3-D visualization software, which can be used to refine the site conceptual model.	Data are compatible with 3-D visualization software, which can be used to refine the site conceptual model.	Data are compatible with 3-D visualization software, which can be used to refine the site conceptual model.	Data are not compatible with 3-D visualization software.	Data are compatible with 3-D visualization software, which can be used to refine the site conceptual model.
Driving Platform	CPT only	CPT only	The system can be used with a variety of direct push equipment .	The system can be used with a variety of direct push equipment.	The system can be used with a variety of direct push equipment .
Investigation Derived Waste	The system produces little to no investigation-derived waste.	The system produces little to no investigation-derived waste.	The system produces little to no investigation-derived waste.	The system produces little to no investigation-derived waste.	The system produces little to no investigation-derived waste.
Push Rate	Depending upon site geology, depth of probes and general site layout, the system is capable of achieving 200 to 300 feet of pushes a day.	Depending upon site geology, depth of probes and general site layout, the system is capable of achieving 200 to 300 feet of pushes a day.	Depending upon site geology, depth of probes and general site layout, the system is capable of achieving 250 to 500 feet per day.	Depending upon site geology, depth of probes and general site layout, the system is capable of achieving 250 to 500 feet per day.	Depending upon site geology, depth of probes and general site layout, the system is capable of achieving 250 to 500 feet per day.
Real Time	Near-real-time data allow for a dynamic characterization that can lead to fewer mobilizations.	Near-real-time data allow for a dynamic characterization that can lead to fewer mobilizations.	Near-real-time data allow for a dynamic characterization that can lead to fewer mobilizations.	Near-real-time data allow for a dynamic characterization that can lead to fewer mobilizations.	Near-real-time data allow for a dynamic characterization that can lead to fewer mobilizations.
Spatial Resolution	The vertical spatial resolution is about 2.0 cm.	The vertical spatial resolution is about 2.0 cm.	The vertical spatial resolution is about 2.5 to 3.0 cm.	Continuous.	The vertical spatial resolution is about 2.5 to 3.0 cm.
Training			While training is required, personnel need not be highly skilled to operate the system with a DP (non-CPT) platform.	While training is required, personnel need not be highly skilled to operate the system with a DP (non-CPT) platform.	While training is required, personnel need not be highly skilled to operate the system with a DP (non-CPT) platform.

	ROST	SCAPS	TARGOST	UV LED	UVOST
Type of NAPL	The system readily detects most light to medium fuels and oils and can generally identify product type.	The system readily detects most light to medium fuels and oils and can generally identify product type.	The system readily detects most light to medium fuels and oils and can generally identify product type.	The system detects light to medium fuels and oils as well as monoaromatics and may be able to identify product type.	The system readily detects most light to medium fuels and oils and can generally identify product type.
Limitations					
Accessibility	Limited to areas where a 20-ton truck can gain access.	Limited to areas where a 20-ton truck can gain access.			
Aqueous Phase	The system does not detect aqueous-phase contamination.	The system does not detect aqueous-phase contamination.	The system does not detect aqueous-phase contamination.	The system does not detect aqueous-phase contamination.	The system does not detect aqueous-phase contamination.
Depth	Depending upon soils encountered can generally be pushed to 50 m.	Depending upon soils encountered can generally be pushed to 50 m.	If used to a DP rig, generally 50 to 100 feet depending upon subsurface material.	If used to a DP rig, generally 50 to 100 feet depending upon subsurface material.	If used to a DP rig, generally 50 to 100 feet depending upon subsurface material.
Driving Platform	CPT only	CPT only	CPT and DP	CPT and DP	CPT and DP
Quantitation	The system provides relative data rather than quantitative data.	The system provides relative data rather than quantitative data.	The system provides relative data rather than quantitative data.	The system provides relative data rather than quantitative data.	The system provides relative data rather than quantitative data.
Training	The operation of the ROST™/CPT requires considerable experience.	The operation of the SCAPS requires considerable experience.	If used with a CPT rig the operation requires considerable experience.	If used with a CPT rig the operation requires considerable experience.	If used with a CPT rig the operation requires considerable experience.
Type of NAPL	The system does not readily identify coal tars, creosote, or bunker oil, nor does it detect monoaromatics or chlorinated aliphatics.	The system does not readily identify coal tars, creosote, or bunker oil, nor does it detect monoaromatics or chlorinated aliphatics.	The system does not detect light fuels and oils or chlorinated aliphatics.	The system does not readily identify coal tars, creosote, or bunker oil, nor does it detect chlorinated aliphatics.	The system does not readily identify coal tars, creosote, or bunker oil, nor does it detect monoaromatics or chlorinated aliphatics.

Source: <http://www.clu-in.org/characterization/technologies/lif.cfm>

LIF – What's Next

- ◆ Dye-LIF for Halogenated NAPLs
 - Fluorescent hydrophobic dye is injected ahead of sapphire window
 - Dye dissolves into NAPL but not in water
 - LIF detects the dye in the NAPL

This device is currently being tested at a number of field sites

Notes

- ◆ The Dye-LIF tool works by injecting fluorescing, hydrophobic dye through a small injection port located several inches below the detection window of a standard LIF probe as the probe is advanced into the subsurface. The injected dye partitions into the NAPL (if present) and fluorescence in the presence of a light source, allowing the same LIF tooling (lasers, optical reading and processing equipment) to be used to detect chlorinated solvent DNAPLs (SERDP Factsheet, ER-201121).

Source: <http://www.clu-in.org/characterization/technologies/lif.cfm>

Sampling and Quantitative Tools for Contaminants



23rd Annual NARPM Training Program

3-51

Direct Push Groundwater Sampling Tools



- ◆ Geoprobe SP16/SP21
 - Small diameter
 - Variable screen length
- ◆ Removed (tripped) following collection of each sample

Notes

- ◆ Direct push groundwater sampling tools and techniques generally can be divided into three groups: sealed-screen samplers, exposed-screen samplers and open-hole sampling.
 - » Sealed Screen Samplers typically consist of a short screen contained within a sealed, water-tight body. To collect the sample, the tool is driven to the desired depth where the protective outer rod is withdrawn exposing the screen to groundwater. The water flows through the screen and into the drive rods or sample chamber. O-ring seals placed between the drive tip and the tool body help ensure that the sampler is water tight as it is driven to the target depth. The integrity of the seal can be checked by lowering an electronic water level indicator into the sampler prior to withdrawing the outer rod. Because the tool is sealed, the potential for cross contamination is greatly reduced and a true depth-specific sample can be collected. The sample volume collected with some sealed screen samplers is limited by the volume of the sample chamber.

These types of samplers can only sample one interval per push. If the sampler uses the walls of the rod for containing the groundwater until it can be retrieved by bailer or pump, care should be taken to ensure that the target contaminants are not sensitive to interaction with iron (for example, dissolved oxygen, redox potential and trace metals).

- » Exposed-screen samplers are capable of collecting groundwater samples at multiple intervals as the sampling tool is advanced, without having to withdraw the tool for sample collection or decontamination. The terminal end of a typical exposed-screen sampler has a 6-inch- to 3-foot-long screen made up of fine-mesh, narrow slots, or small holes. The screen remains open to formation materials and water while the tool is advanced. This allows samples to be collected either continuously or periodically as the tool is advanced to vertically profile groundwater chemistry and aqueous-phase contaminant distribution.

Exposed-screen samplers can be used to measure water levels at discrete intervals within moderate- to high-yield formations to assist in defining vertical head distribution and gradient. Additionally, some of these tools can be used to conduct hydraulic tests at specific intervals to characterize the hydraulic conductivity of formations to identify possible preferential flow pathways and barriers to flow.

- » Open-hole sampling is conducted by advancing drive rods with a drive point to the desired sampling depth. Upon reaching the sampling depth, the rods are withdrawn slightly which separates them from the drive tip and allows water to enter. The water can be sampled by lowering a bailer into the rods or by pumping. The open-hole method is only feasible within formations that are fairly cohesive, otherwise the formation soil may flow upwards into the rods when they are withdrawn, preventing water samples from being collected. With single-rod systems, open-hole sampling can only be conducted at one depth within a borehole because the borehole cannot be flushed out between sampling intervals and cross-contamination may occur.

Source: <http://www.clu-in.org/characterization/technologies/dpgroundwater.cfm>

Integrated Data Acquisition

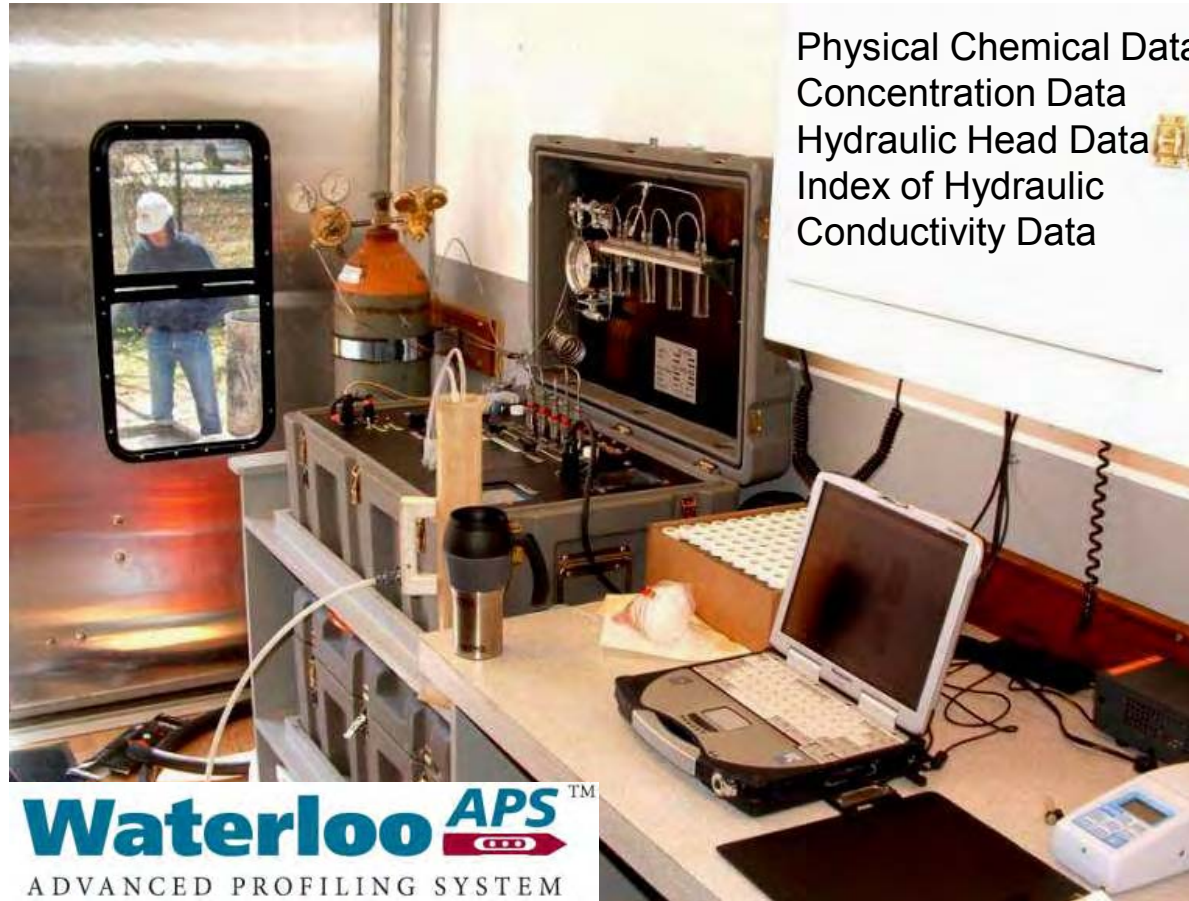

Physical Chemical Data
Concentration Data
Hydraulic Head Data
Index of Hydraulic
Conductivity Data

Notes



- ◆ The original Waterloo Profiler has been modified to allow for the collection of detailed data relative to contaminant concentrations, the distribution of hydraulic conductivity and hydraulic head as well as pH, specific conductance, dissolved oxygen and oxidation reduction potential in a single push.

Source: Stone Environmental, Inc.

Profiler Hardware and Tip Modifications

1994 Waterloo Profiler

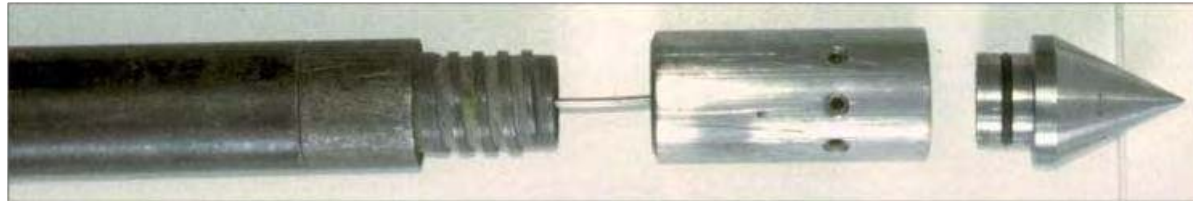

Waterloo Advanced Profiling System (Waterloo^{APST}[™])



Notes

- ◆ A variety of modifications have been made to the profiler in response to a variety of site conditions. The original version shown at the far left did not have a disposable point and was incapable of retraction grouting. It had recessed screens in 5/32 inch diameter ports. The second tip from left was developed to allow for retraction grouting. The middle tip is simply a smaller diameter version of the original which was built to be used with EW drill rod and allow for greater depth penetration under some conditions. The second tip from the right has two rows of 1/4 inch diameter ports and the screens are flush with the profiler surface. The tip has been beveled to provide some relief for soil “rebound” and to protect the screens from being ripped by rocks. These modifications made the profiler less prone to plugging up in fine sediments. The tip of the right has four rows of 1/4 inch ports and was developed to provide faster sampling times in low permeability settings.

Source: Stone Environmental, Inc.

Waterloo^{APS} Sampling Configurations

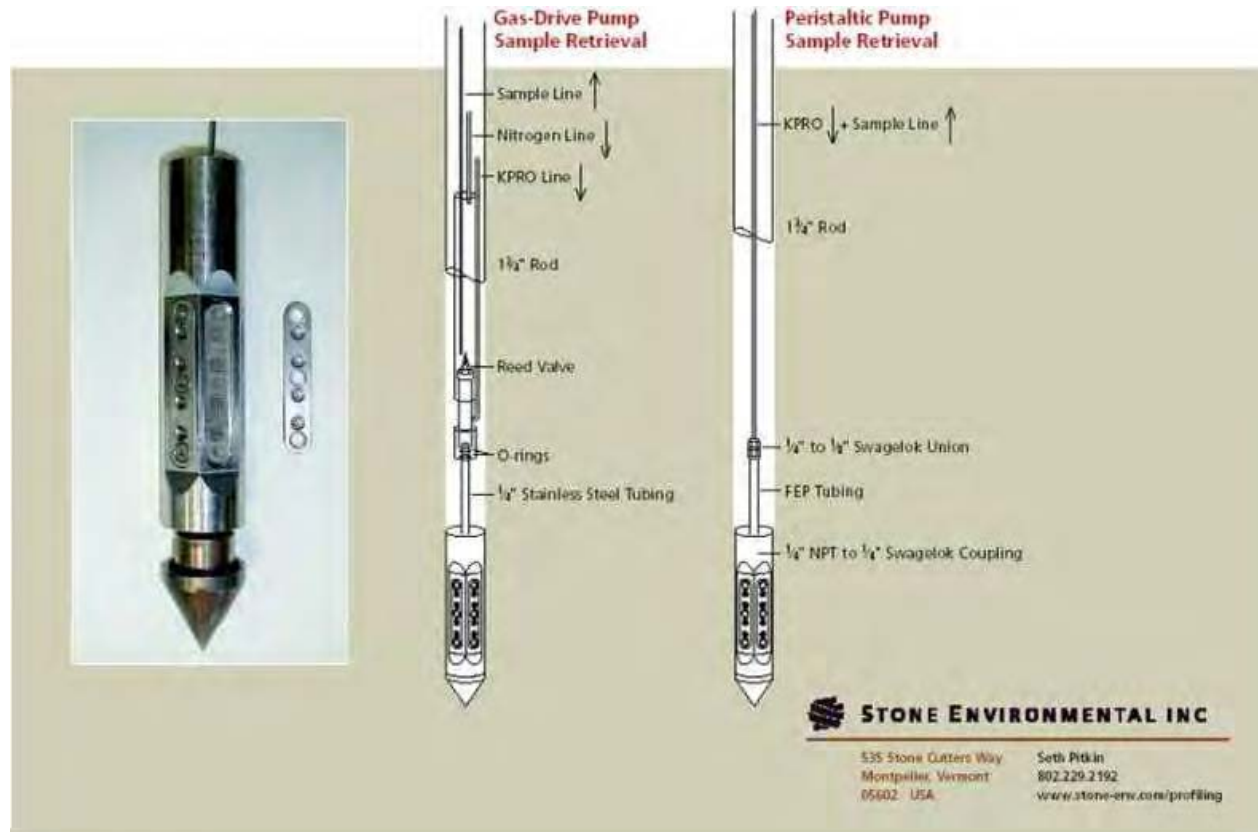

Notes

- ◆ The Waterloo^{APS} has two options for pumping of formation water. On the left is a schematic diagram of a positive displacement nitrogen gas drive pump, which pushes that water up from the bottom of the drill string. On the right is a schematic of a version of the tool used with a peristaltic pump located uphole.

Source:

- » Stone Environmental, Inc.
- » <http://www.clu-in.org/characterization/technologies/dpgroundwater.cfm>

Waterloo^{APS} Data Acquisition Configuration and Process

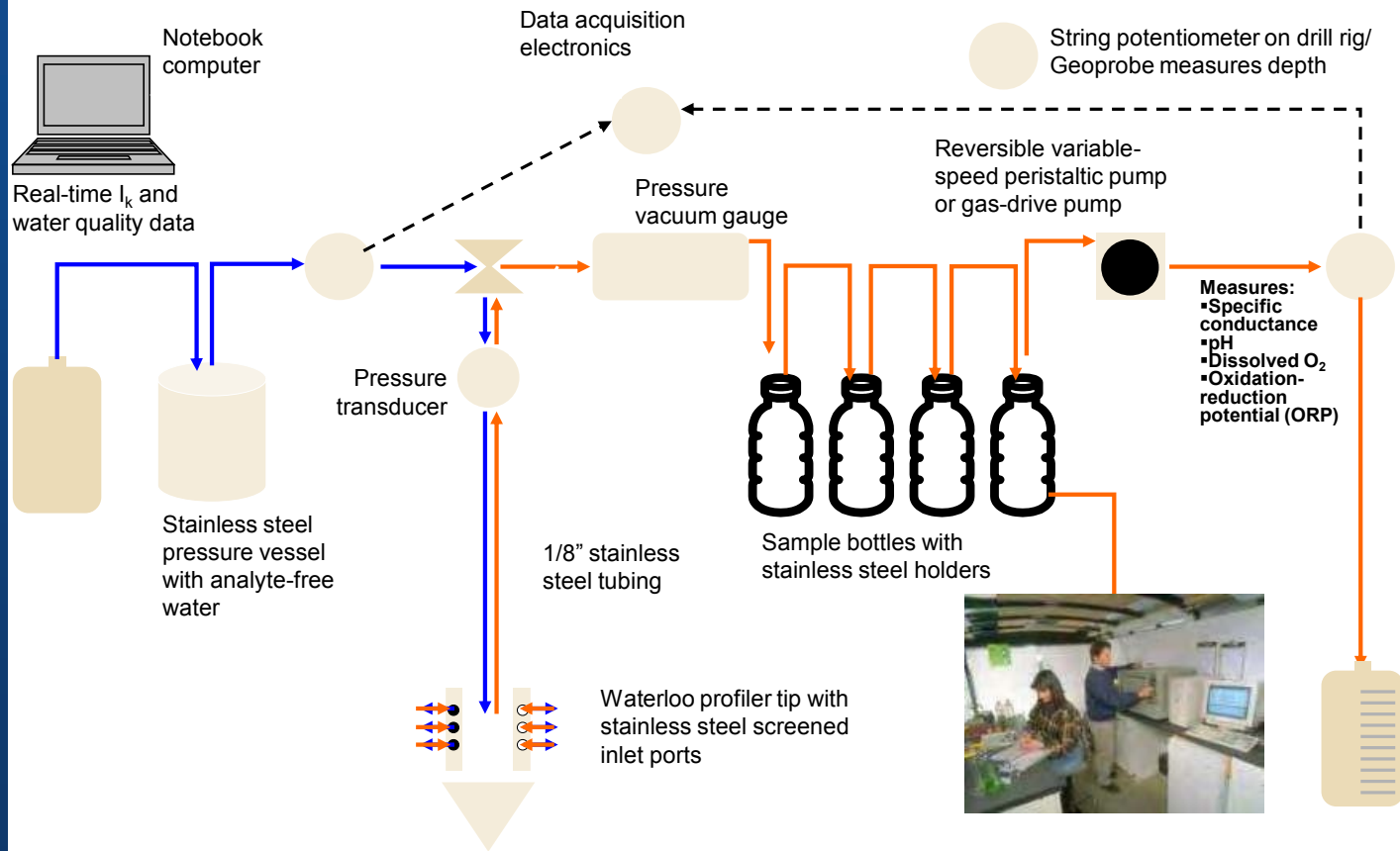

Notes

- ◆ The Waterloo^{APS}TM allows physiochemical data acquisition. The stainless-steel profiling tip has 16 ports arranged in four rows, resulting in an open sampling interval approximately 2.5 inches in length. Each of the rows is recessed and fitted with dual filter screens. The mesh size of the inner screen can be changed to reduce turbidity or optimize sampling productivity. To minimize sorption of contaminants to system materials, stainless steel tubing conveys groundwater from the profiling tip to the sample collection apparatus at the surface. A sacrificial profiling tip allows retraction grouting of completed profiling boreholes. Samples are collected directly into glass, zero-headspace, in-line sample containers that prevent sample contact with system materials and ambient air. The containers are located on the suction side of the peristaltic pump to prevent contact with pump head tubing during use of that sampling method.

Sources:

- » Stone Environmental, Inc.
- » <http://www.clu-in.org/characterization/technologies/dpgroundwater.cfm>

Two Uses of I_K Data

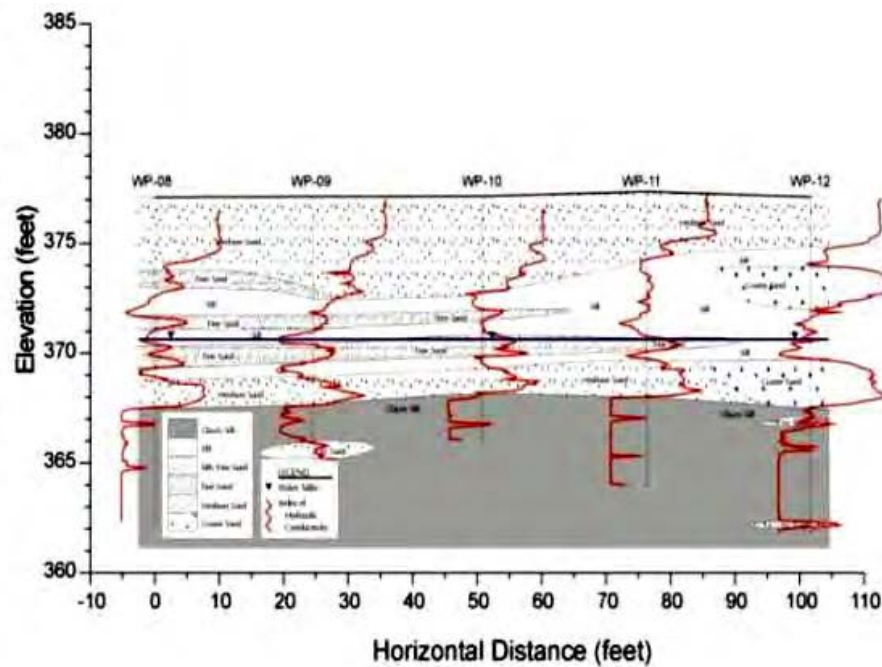
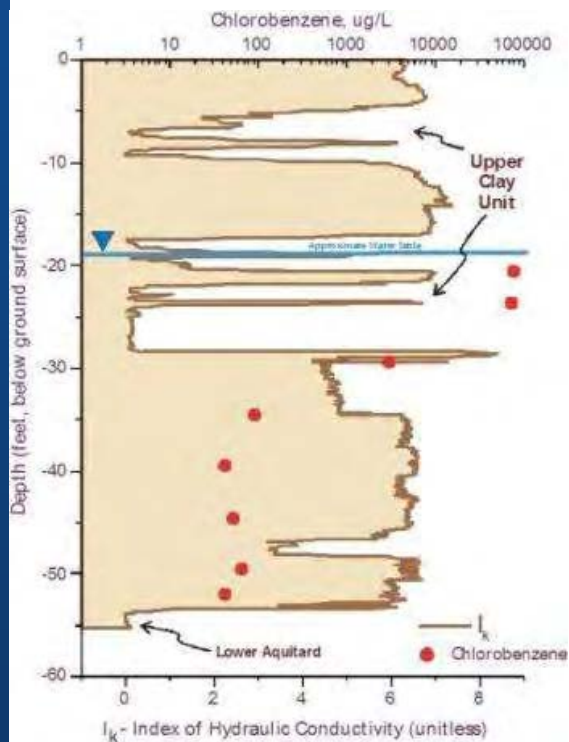

Notes



- ◆ The I_k data generated by the Waterloo^{APS™} can be used to (1) select sample collection depths from a single profiling point and (2) develop detailed stratigraphic interpretations from multiple profiling points.

Source: Stone Environmental, Inc.

Waterloo^{APS} Multiple Data Set

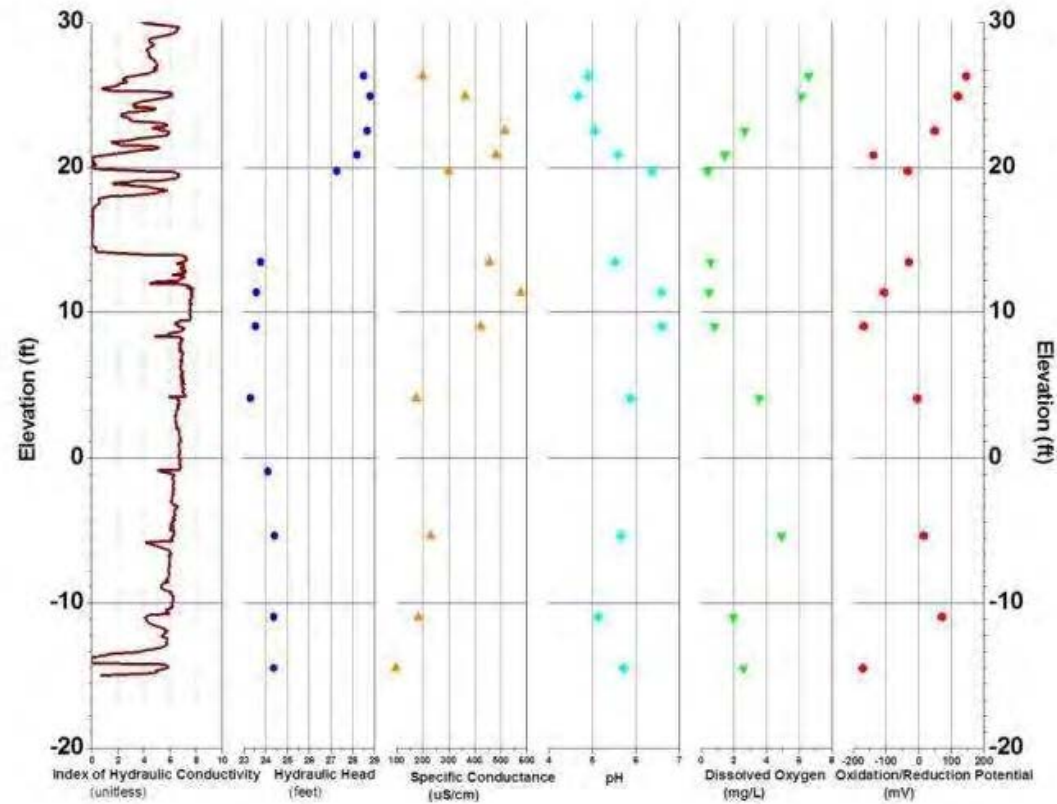

Notes



- ◆ The Waterloo^{APS™} system provides multiple data sets for a single profiling point, including, the distribution of hydraulic conductivity and hydraulic head as well as pH, specific conductance, dissolved oxygen and oxidation reduction potential in a single push. These physical parameters are then correlated with contaminant concentrations.

Source: Stone Environmental, Inc.

MIP and Waterloo^{APS}

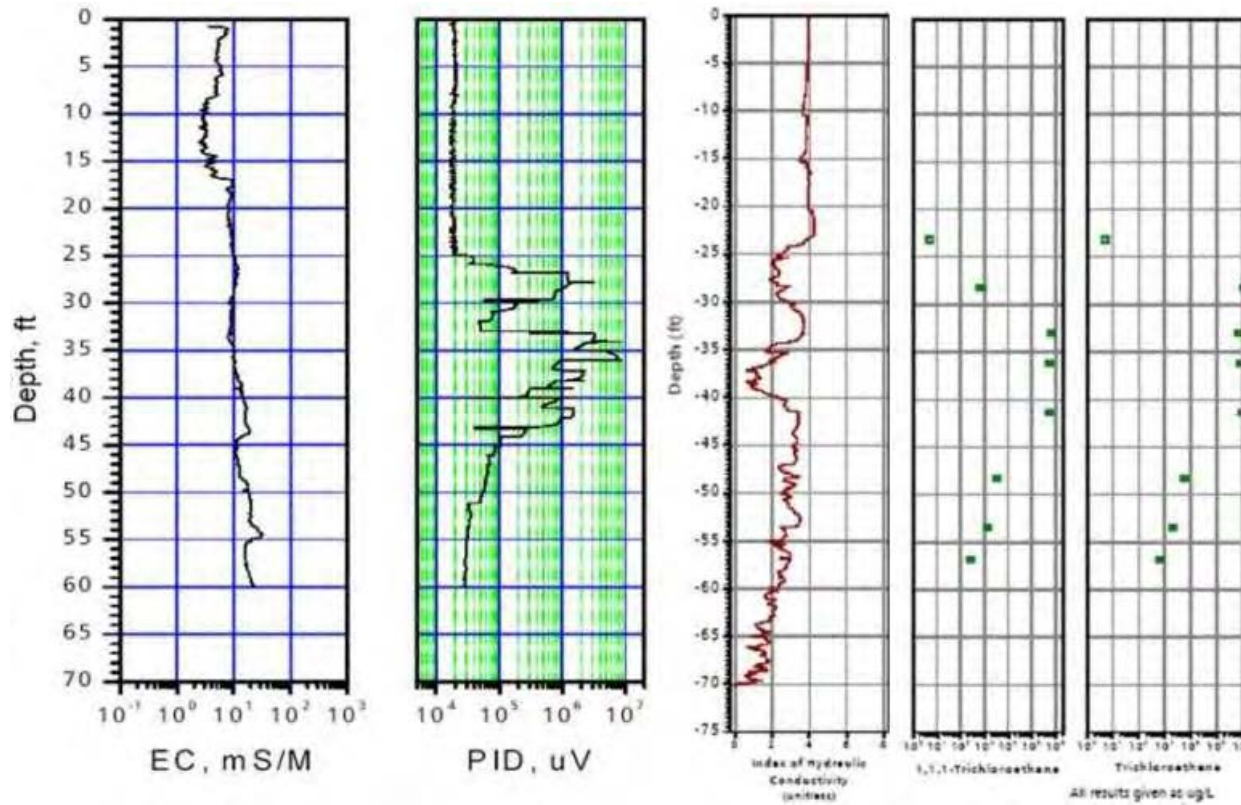

Notes

- ◆ The Waterloo^{APS™} can be used in combination with other direct measuring devices, such as a membrane interface probe. This slide shows two MIP data readouts for electrical conductivity and PID contaminant levels compared to I_K and contaminant concentrations from the Waterloo^{APS™} system.

Source: Stone Environmental, Inc.

Applicability and Data Generated for Some Innovative Overburden Technologies

Geologic Applicability	MIP	LIF	Waterloo APS *	CPT *	Sonic Drilling *
Gravel	1	1			
Sand					
Silt & Clay			2		
Glacial Till	1	1	1	2	
Type of Data Generated					
Geologic Conditions (quantitative)	3	3			4
Hydrogeology Parameters					
Head					
Permeability (quantitative or relative)					4
Contaminants					
DNAPL (chlorinated solvents)	5		6	6	
LNAPL	5		6	6	
VOCs					
Speciation	5		6	6	6
Concentration	5		6	6	6
Vertical Distribution:			6	6	7
Vadose Zone					7
Saturated Zone			6	6	7
High K Matrix			6	6	7
Low K Matrix					7
Other Contaminants			6	6	6
Approximate Cost (USA) **					
Day Rate	\$2,800	\$3,100	\$2,500	\$5,200	\$5,200
Additional Tools (Geoprobe or Field Lab)	\$2,200	\$2,200	\$4,400	\$2,200	\$3,500
ERM Oversight & Field Expenses	\$1,500	\$1,500	\$1,500	\$1,500	\$3,000
Total per Day	\$6,500	\$6,800	\$8,400	\$8,900	\$11,700
Approximate Production Rate ***					
Borehole Advanced (feet per day)	100-250	300-400	50-100	200-400	100-200
Soil samples/data per day	continuous	continuous	NA	NA	50-200
Groundwater samples/data per day	NA	NA	5-10	5-10	5-10

■ tool applicable to this environment
■ tool may be applicable
■ tool is not applicable

© Copyright 2010 by ERM

Notes



- ◆ ERM developed the chart above to compare the applicability and data generated of several innovative overburden technologies.

Source: Taken from “Overburden Tool Matrix.xls”

Hybrid drive platforms
Sampling systems

TOOLS FOR DEEP UNCONSOLIDATED ENVIRONMENTS



23rd Annual NARPM Training Program

3-61



Hybrid Drive Platforms

Profiling to depths > 550 ft

Enhanced Access Penetration System (EAPS) Approach for Drilling in Deep Unconsolidated Geology

- ◆ Implement overburden drilling to penetrate through refusal layers
 - Air rotary drilling combined with an under-reaming feature
 - Used to install casing through refusal layers
 - Casing eliminates sidewall friction, allowing for extremely deep penetration of Wireline
- ◆ Wireline sampling tools
 - Continuous gas sampling in vadose zone
 - Soil sampling at selected depths
 - Groundwater sampling at selected depths

Notes

- ◆ Enhanced Access Penetration System (EAPS) is designed to extend CPT penetration depth, conduct real-time sample collection and analysis, and contain drilling waste material. EAPS consists of four major components:
 - » Wireline CPT and gas sampling probe and wireline soil and groundwater sampling system
 - » Small diameter air rotary drilling system
 - » Environmental sensors that are used to detect and characterize contamination in both real and near-real time
 - » Integral drill spoils collection and filtration system

Source: Applied Research Associates, Inc. 2004. Enhanced Access Penetration System (EAPS) Draft Final Technical Report. January.

http://www.clu-in.org/download/char/enhanced_dp_evaluation_report.pdf

Internet

EPA Contaminated Site Clean-Up Information (CLU-IN) Additional Resources and Documents (<http://clu-in.org/resources/>)

EAPS – Selected Bits and Tools Used With Drill System



Notes



- ◆ EAPS uses various drilling bits in combination with sampling tools, as shown above.

Source: Applied Research Associates, Inc. 2004. Enhanced Access Penetration System (EAPS) Draft Final Technical Report. January.

http://www.clu-in.org/download/char/enhanced_dp_evaluation_report.pdf

EAPS Configured for CPT Overburden and Combination CPT – Rotary

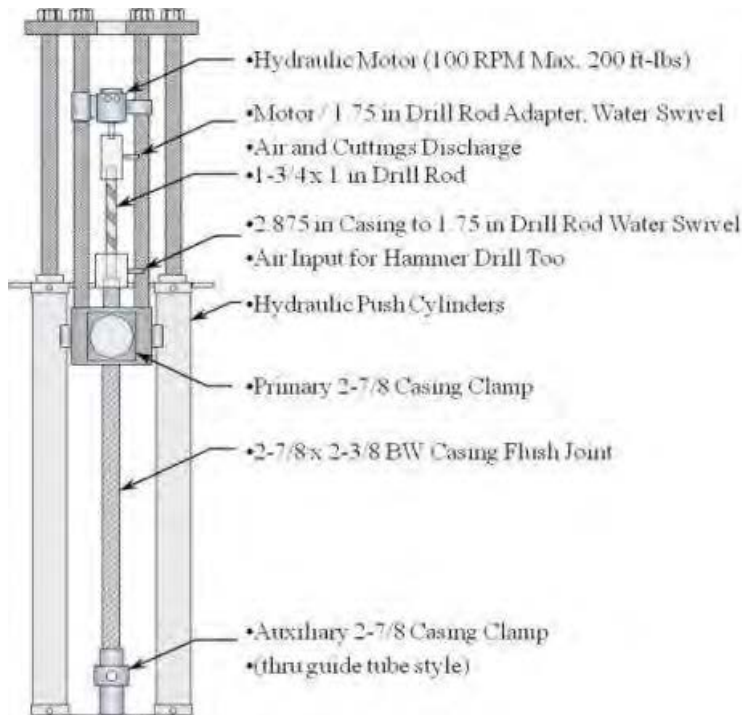



- ◆ EAPS employs a progressively invasive approach to characterization to minimize drilling spoils, potential for personnel exposure, penetration time and costs. Utilizing CPT as its base platform, and resorting to drilling only when necessary to penetrate resistive materials, EAPS maintains all the advantages of conventional CPT. ARA's Wireline CPT technology comprises the heart of EAPS, allowing various characterization tools and drills to be exchanged without removing the advancing rod string from the ground.

Wireline characterization tools provide real time, in situ characterization data in addition to a means of collecting soil and water samples. In the vadose zone a soil gas sampling CPT piezocone can be used. This tool enables profiles of both geotechnical properties and gaseous contaminant concentrations to be obtained simultaneously.

The Wireline soil sampler can be used to obtain physical samples at any depth in the profile. Once the water table is encountered, groundwater sampling can be performed using the Wireline water sampler tool, which incorporates a modified, air-actuated bladder pump.

When a geologic formation is encountered that causes refusal in the primary direct push mode, further advancement is attempted using a small-diameter, wireline deployable drill. Should the small-diameter drill meet refusal in the formation, a larger diameter drill can be deployed to penetrate the refusal layer and set a casing through which the wireline system can telescope to resume characterization below.

As shown in the slide above, the CPT push system was modified to incorporate a rotary hydraulic drill head that can be swung out of the way during CPT sounding. To engage drill mode, the drill head is swung into position and locked into place.

Source: Applied Research Associates, Inc. 2004. Enhanced Access Penetration System (EAPS) Draft Final Technical Report. January.

http://www.clu-in.org/download/char/enhanced_dp_evaluation_report.pdf

EAPS – CPT Wireline Sampling Systems

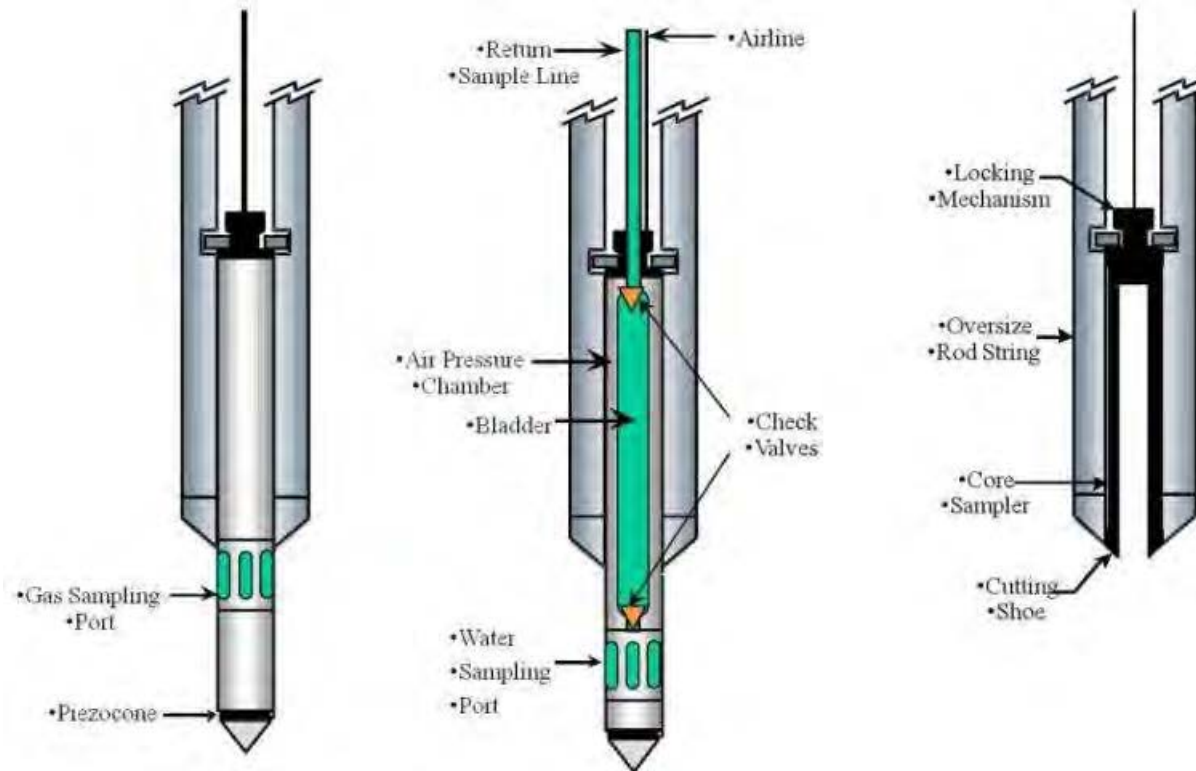

Notes

- ◆ The Wireline CPT/Gas sampling probe is used to determine soil stratigraphy and profile contaminants in real time. Once refusal occurs, the CPT/Gas sampling probe is withdrawn, leaving the push casing in place. A small diameter air rotary drill is then lowered through the casing and locked into the bottom end. This drill is used to penetrate the refusal layer. The return air and drill cuttings are routed through a series of filters to remove the drill cuttings. Volatile organic contaminants in the air stream are retained in a Granulated Carbon Trap ensuring that only clean air is emitted into the atmosphere. Once through the refusal layer, the Wireline CPT/Gas sampling probe sounding is resumed. At any depth of special interest, the Wireline CPT/Gas sampling probe can be removed and soil or water samples collected (again, without removing the casing) for either on-site or off-site testing.

Source: Applied Research Associates, Inc. 2004. Enhanced Access Penetration System (EAPS) Draft Final Technical Report. January.

http://www.clu-in.org/download/char/enhanced_dp_evaluation_report.pdf

Internet

EPA Contaminated Site Clean-Up Information (CLU-IN) Additional Resources and Documents (<http://clu-in.org/resources/>)

Borehole geophysics
Multi-level sampling tools
Packer testing
FLUTE liners
Discrete Fracture Network Approach

TOOLS FOR FRACTURED OR POROUS MEDIA ENVIRONMENTS

Borehole Tool Matrix

Target	Readily Available		Specialty	
	Primary Tools	Secondary Tools	Common	Limited
Lithology and mineralogy	<ul style="list-style-type: none"> Gamma Conductivity / Resistivity Spectral gamma 	<ul style="list-style-type: none"> Acoustic televiewer Video Optical televiewer Magnetic susceptibility Full waveform seismic 	<ul style="list-style-type: none"> Density Neutron Vertical seismic profiling 	<ul style="list-style-type: none"> Temperature ALS FMI NMR
Weathering	<ul style="list-style-type: none"> Full waveform seismic Video 	<ul style="list-style-type: none"> Cross hole seismic Acoustic televiewer Conductivity/Resistivity + Gamma 	<ul style="list-style-type: none"> Magnetic susceptibility Density Neutron 	<ul style="list-style-type: none"> Vertical seismic profiling
Elastic properties	<ul style="list-style-type: none"> Full waveform seismic 	<ul style="list-style-type: none"> Vertical seismic profiling 	<ul style="list-style-type: none"> Cross hole seismic 	
Porosity		<ul style="list-style-type: none"> Active temperature Conductivity / Resistivity 	<ul style="list-style-type: none"> Neutron 	<ul style="list-style-type: none"> NMR Induced polarization
Bulk Fracturing	<ul style="list-style-type: none"> Temperature Acoustic televiewer Video Optical televiewer 	<ul style="list-style-type: none"> Caliper Conductivity / Resistivity Full waveform seismic 	<ul style="list-style-type: none"> Micro resistivity Neutron Density GPR 	<ul style="list-style-type: none"> Tube wave seismic
Individual Fractures	<ul style="list-style-type: none"> Acoustic televiewer Video Optical televiewer 	<ul style="list-style-type: none"> Caliper Temperature passive 	<ul style="list-style-type: none"> Temperature ALS GPR 	<ul style="list-style-type: none"> Tube wave seismic Micro-resistivity
Orientation of fracturing	<ul style="list-style-type: none"> Acoustic televiewer Optical televiewer 		<ul style="list-style-type: none"> GPR 	<ul style="list-style-type: none"> 4 arm dip-meter FMI
Water Flow cross-connected	<ul style="list-style-type: none"> Heat pulse flow meter Impeller flow meter 	<ul style="list-style-type: none"> Temperature open-hole Video 	<ul style="list-style-type: none"> Temperature ALS 	<ul style="list-style-type: none"> FEC with BH dilution Electromagnetic flow-meter
Water Flow ambient	<ul style="list-style-type: none"> Temperature passive lined-hole 		<ul style="list-style-type: none"> Temperature ALS lined-hole 	
Water Quality	<ul style="list-style-type: none"> Conductivity / Resistivity Water Conductivity 	<ul style="list-style-type: none"> Direct sampler 	<ul style="list-style-type: none"> Ph, DO, Redox, Salinity 	
Borehole Properties	<ul style="list-style-type: none"> Acoustic televiewer Caliper 	<ul style="list-style-type: none"> Full waveform seismic 	<ul style="list-style-type: none"> Magnetic (+ tilt-meter) deviation Borehole (gyro) deviation 	<ul style="list-style-type: none"> FMI

Pehme, Parker and Cherry, 2011



23rd Annual NARPM Training Program

3-68

Notes



- ◆ The table above was developed by Peeter E. Pehme, Beth L. Parker and John A. Cherry and presented in the Discrete Fractured Network (DFN) Article 5 in April 2011. DFN Article 5 states,

“Table 1 summarizes the borehole geophysical technologies generally available and indicates the type of insights that each is intended to provide in the context of (i) mineralogy/lithology, (ii) rock matrix porosity and physical properties, (iii) borehole geometric features and fracturing, (iv) groundwater flow, (v) groundwater/fluid chemistry and (vi) borehole properties. There is a subtle but important distinction between the properties measured (e.g., an abrupt, narrow change in borehole diameter) and the inferences from that measurement (i.e., a fracture exists) that requires experience to properly assess. Some geophysical tools can be applied in lined holes while others cannot. The diameters of some tools may prevent their use in some boreholes. As for all measurements done in open boreholes through contaminated zones, including packer hydraulic tests, there is a trade-off between the value of the information obtained and the undesirable potential for cross-contamination occurring over the period of time when borehole data collection is being conducted. One of the methods indicated in Table 1, high resolution temperature profiling, is particularly well suited for applications in lined (sealed) holes and is described in more detail in DFN Article 4. Based on our experience applying the DFN Approach at contaminated sites, some geophysical methods that require an open hole, most notably borehole flow metering and full borehole salinity dilution (FEC) logging, should be avoided or minimized in contaminated areas. Geophysical logging results are used in the DFN Approach in conjunction with other types of borehole information to develop comprehensive interpretations of the hydrogeological conditions at the borehole location, an example of which is shown in Figure 1. Data from the core and the gamma log are used to establish the geological units. The geological log and image logs (acoustic televiewer and video) provide for visual identification of features, including bugs, fractures, fracture zones and lithology contrasts, but cannot indicate whether these features are capable of or presently transmitting groundwater (i.e., open with flow or connectivity versus closed, sealed fractures). The FLUTe™ liner (see Article 3) transmissivity (T) profile provides evidence of permeable fractures, and the high resolution temperature profile (Flow Interp) identifies fractures for which this method indicates detectable groundwater flow under ambient flow conditions. Borehole geophysics plays an important role in the procedure that produces these values because the image logs, the caliper logs and the temperature profiles contribute important evidence used to assign the number of permeable fractures (N) to each hydraulic test interval for which transmissivity (T) values have been produced. The assignment of N to each interval is based on comparing all lines of evidence for what constitutes a permeable fracture. The data sets available depend on the site, mode of contaminant distribution and circumstances of the investigation. However, gathering as much of this data as practical provides essential inputs for planning multilevel installations, modeling contaminant transport and fate, and formulating a DFN conceptual model to guide the decision making process. The degree to which the various borehole geophysical methods add value in the DFN approach can depend on the site-specific conditions, and the assessment of geophysical methods is an ongoing process. Advanced methods of geophysical logging used in the petroleum industry are now being used in the groundwater field; our experience with these methods is in the early phase and therefore will not elaborate upon them further in this article.”

Source: U.S. Department of Energy. Energy Technology Engineering Center. Groundwater Flow. 2011. Appendix. DFN Article 5. April.

http://www.etec.energy.gov/Library/Main/Site_Tour_Appendix.pdf

Some Multi-level Characterization/Monitoring Approaches in Fractured Rock

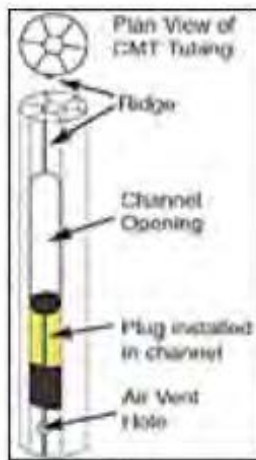

CMT

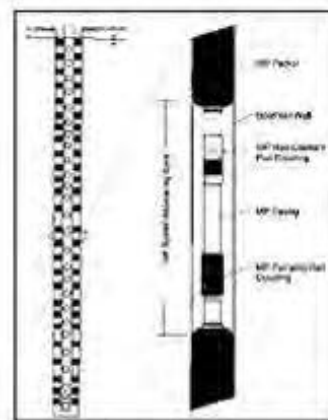

Westbay

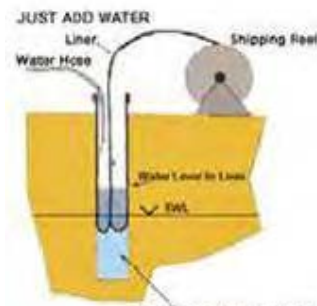

FLUTE

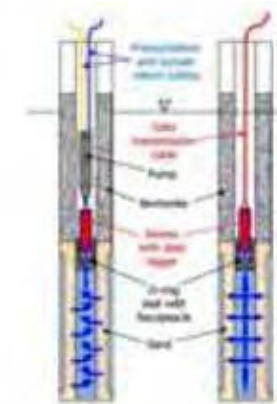

Barcad (ZIST)

Notes



- ◆ Multi-level sampling systems isolate multiple monitoring intervals in a single well. These systems monitor pressure and chemistry. The following systems are available:
 - » **Continuous Multichannel Tubing (CMT) Multilevel System** is a reliable, accurate, easy to use and affordable option to better understand and monitor subsurface groundwater flow and distribution of contaminants. The system provides both vertical and horizontal data.
 - » **Westbay System** design isolates multiple monitoring zones and provides the ability to monitor multiple discrete levels in a single borehole without cross-contamination. This system can be used for broad spectrum of applications associated with environmental, geological, geotechnical and groundwater related projects.
 - » **Flexible Liner Underground Technologies Ltd. (FLUTe)** is an efficient and cost effective tool for measuring the vertical profile of groundwater characteristics from a single borehole. The tool consists of three components: flexible nylon liner, sampling ports (within the liner), and a tubing and valve system.
 - » **BarCad System** is a simple, accurate and cost-effective approach to multipoint groundwater monitoring for characterizing the extent of contamination and for monitoring remediation efforts. The system uses an inert gas drive system to extract samples, eliminating the use of submersible or peristaltic pumps.

Source: Fractured Bedrock Field Methods and Analytical Tools. 2010. Volume II: Appendices. April.

<http://www.sabcs.chem.uvic.ca/May%2024%20Final%20%20SABCS%20Fract%20BR%20Appendices-Vol2.pdf>

Packer Testing



Pat Quinn – University of Guelph

- ◆ Measure hydraulic head
- ◆ Measure hydraulic conductivity
 - Calculate effective fracture aperture
- ◆ Collect water samples from isolated section of borehole

Notes

- ◆ Packer tests isolate sections of a bedrock borehole with bladders (packers) so water-quality samples can be collected and aquifer tests can be performed. These tests define the vertical distribution of water quality and hydraulic conductivity in an aquifer, as well as providing the data necessary to properly place future monitoring wells.

Advantages:

- » Typically less expensive than a collection of wells and gives more continuous record
- » Provides vertical distribution of hydraulic properties and water quality in the aquifer

Disadvantages:

- » Packers may leak
- » Packers can create an open conduit for contaminant movement to depth within an aquifer if left open after drilling without a temporary packer

Cross-Connected

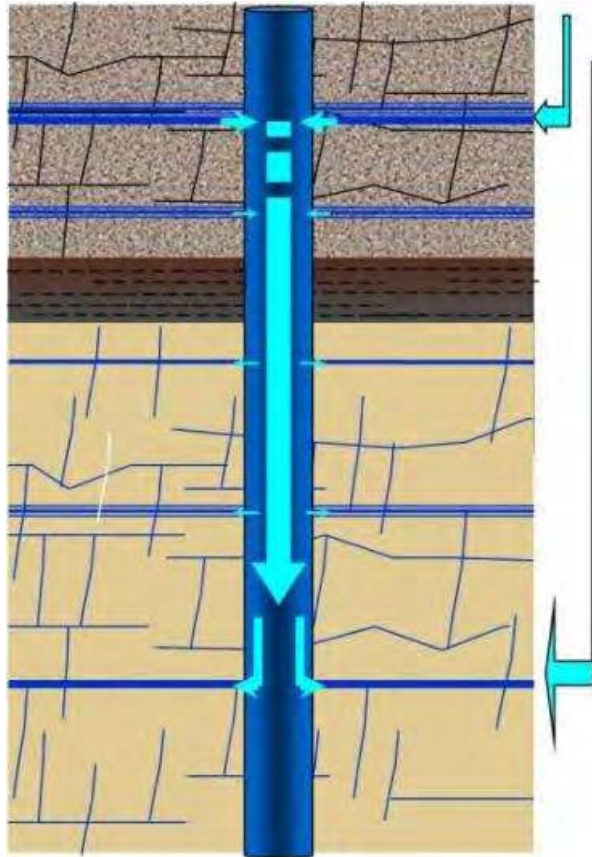

Not Cross-Connected

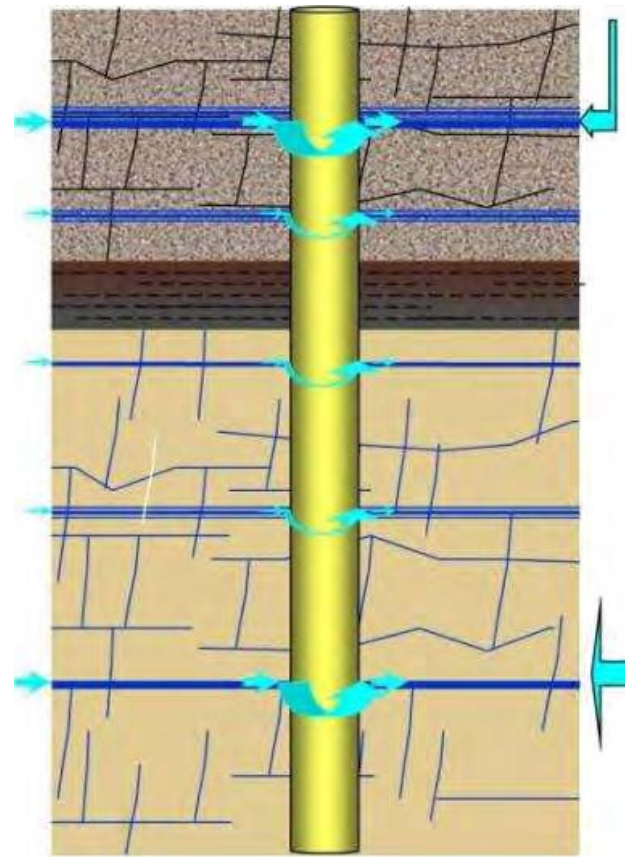

P. Pehme, 2006

Notes

- ◆ This slide shows cross connections between fractures in the open borehole on the left. Water moves into and down the borehole and then horizontally into fractures. The borehole on the right adds a liner to the system to seal the borehole. The water moving through the fractures flows around the liner and not down the borehole annulus.

Source: Pehme, Peeter, Beth Parker, John A. Cherry and John P. Greenhouse. The Potential for Compromised Interpretations When Based on Open Borehole Geophysical Data in Fractured Rock. 2006.

<http://info.ngwa.org/gwol/pdf/070282398.pdf>

FLUTe K – Profiling During Liner Installation

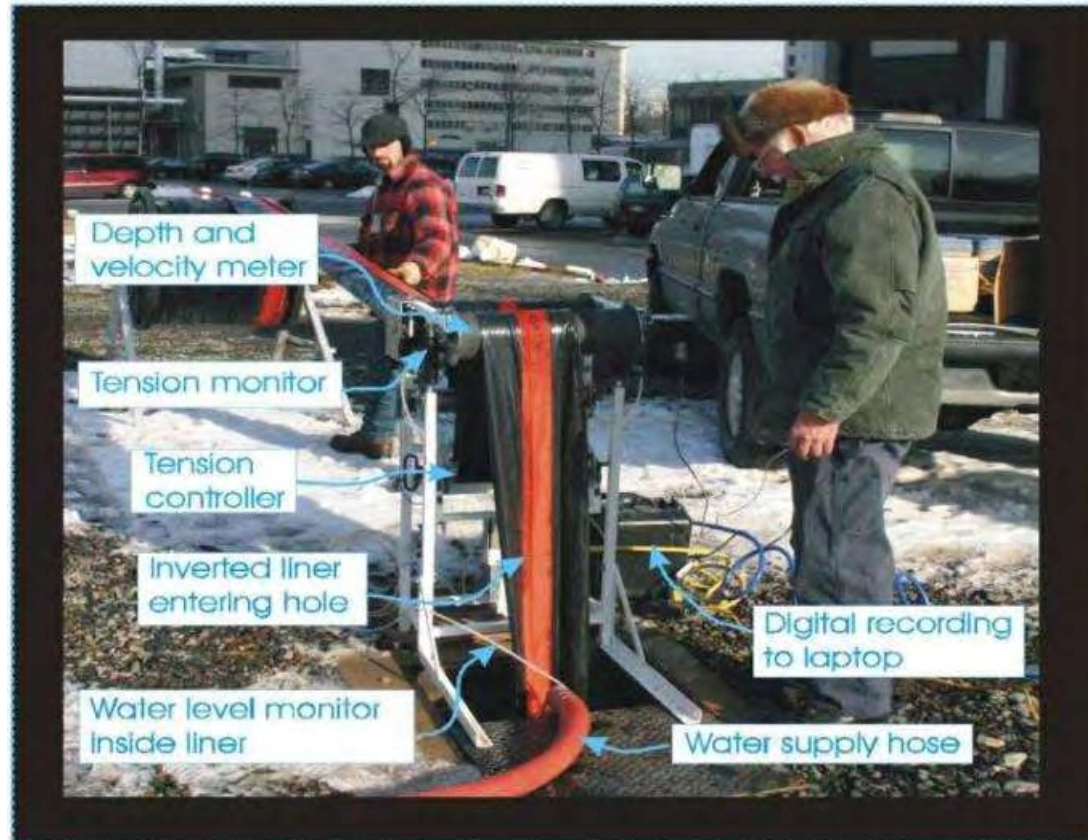

Notes

- ◆ This slide depicts profiling during installation of a FLUTE liner.

Source:

- » http://www.ch2m.com/corporate/services/environmental_management_and_planning/assets/Abstracts/Abstract_129_Ottoson_Poster.pdf
- » http://www.flut.com/sys_1.html
- » http://www.slb.com/services/additional/water/monitoring/multilevel_well_system/multilevel.aspx
- » http://www.haling-associates.com/pdf/BarCad_info.pdf
- » <http://www.hydroterra.com.au/Hydroterra%20PDF/403.pdf>

FLUTe Liner Profile Shows Transmissive Zones

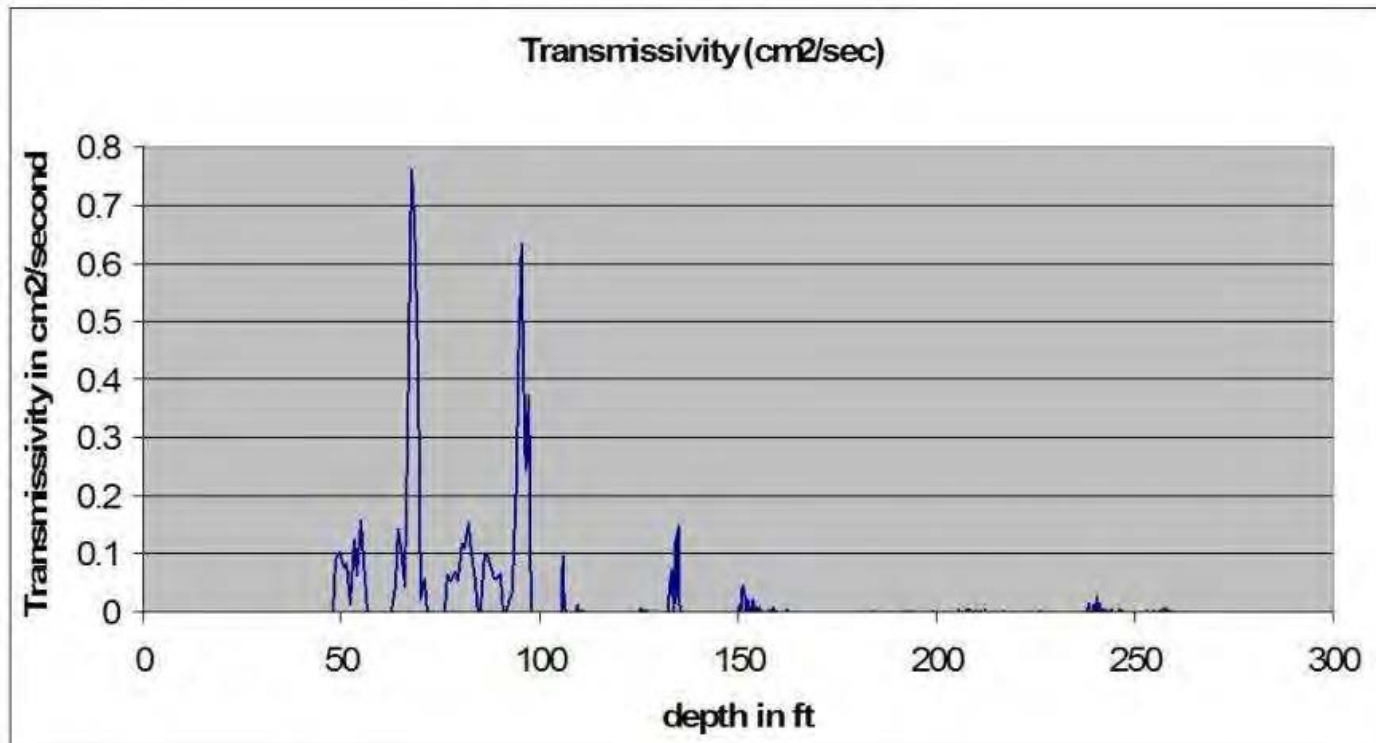

Notes



- ◆ This slide shows the liner profile developed at the Guelph Site MW-26 through work by Beth Parker from the University of Guelph. The profile shows the transmissive zones within the fractured bedrock.

Diffusion Into Rock Matrix

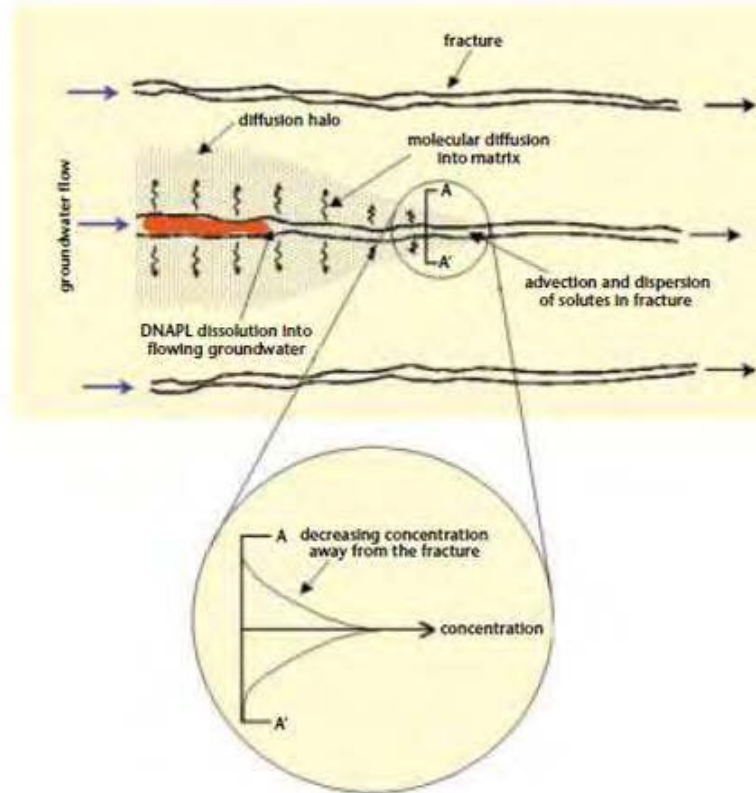

Notes

- ◆ Matrix diffusion is of primary concern in fractured rock systems, especially with regard to DNAPL. The document “An Illustrated Handbook of DNAPL Transport and Fate in the Subsurface,” Environment Agency of the United Kingdom, R&D Publication 133, June 2003, states, “With respect to physical processes influencing plume behavior, there is one fundamental difference between porous and fractured media. Plumes in fractured clay and rock are subject to a process known as matrix diffusion. Matrix diffusion refers to the process whereby solutes dissolved in groundwater diffuse into and out of the rock matrix. If concentrations are higher in the open fracture, the diffusion process will result in dissolved contaminants moving into the rock matrix (forward diffusion). If concentrations are higher in the rock matrix, dissolved contaminants will move out of the rock matrix and into water in the open fractures (back diffusion).”

Source: Kueper, B.H. et al. 2003. An Illustrated Handbook of DNAPL Transport and Fate in the Subsurface. Environment Agency of the United Kingdom. R&D Publication 133, June. www.environment-agency.gov.uk.

Contamination in Fractured Porous Media

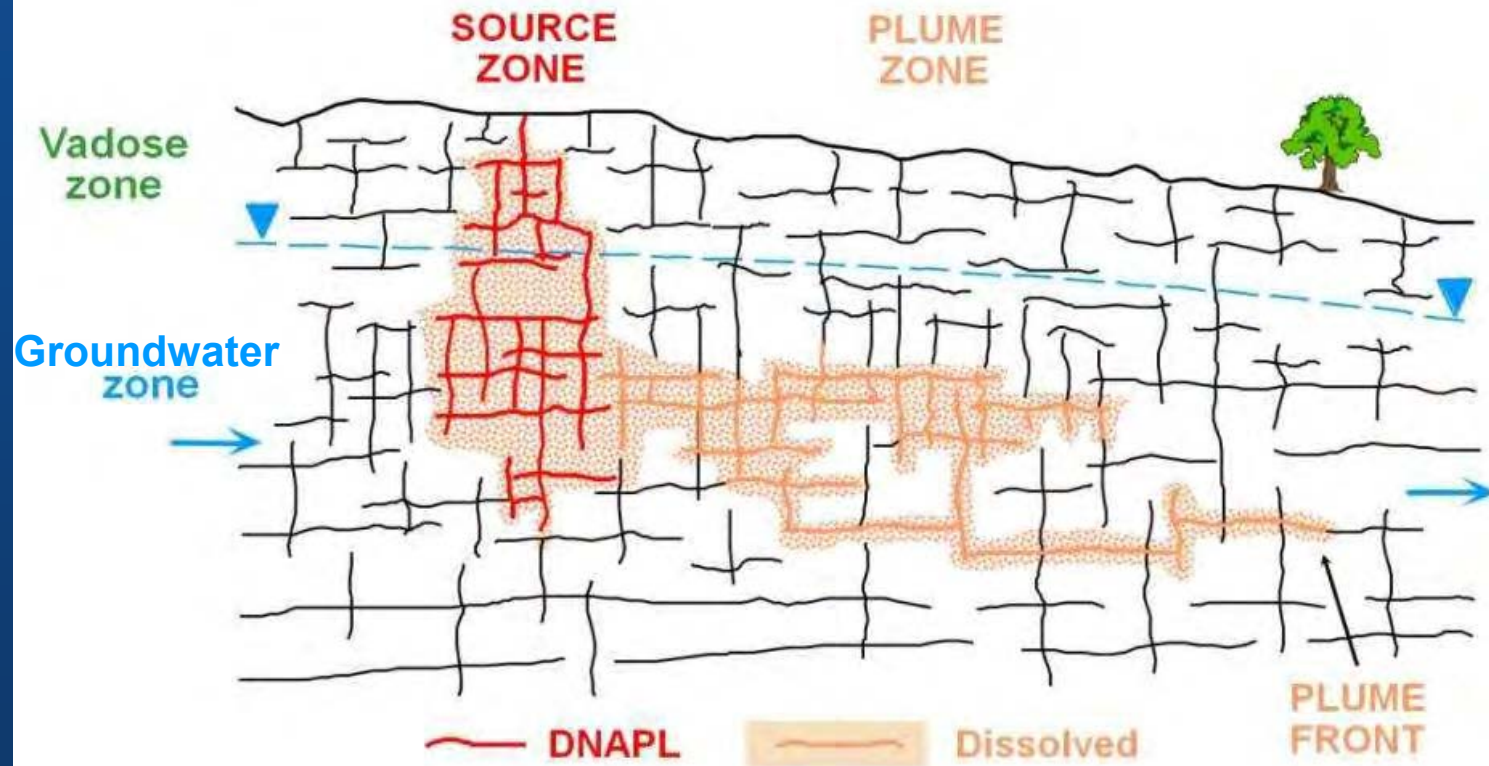

From B.L. Parker



23rd Annual NARPM Training Program

3-75

Notes

- ◆ In Article 2 of the DFN series by Beth Parker, et al. it is stated, “Although nearly all groundwater flow occurs in the interconnected fractures, rock core contaminant analysis from our studies at numerous site shows that nearly all contaminant mass occurs in the low permeability rock matrix (Figure 1) Although drilling does not disturb the contamination in the matrix, we need to be mindful of the extend of dense non-aqueous phase liquid (DNAPL) dissolution and incorporate it into our drilling plans to prevent possible cross-connection/downward mobilization.” The figure above shows that the rock matrix holds most of the contaminant mass.

Reference

Parker, Beth L. 2011. Article 2 – The Discrete Fracture Network (DFN) Approach for Contaminated Bedrock Site Characterization. Center for Applied Groundwater Research. April.

NOTE: This slide can be viewed in color in the Appendix A to this manual.

CORE DFN™

DISCRETE FRACTURE NETWORK APPROACH

DFN Approach Process

Step 1. Core HQ vertical hole

Sample length:
~1-2 inches

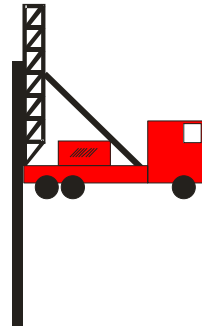

Step 2. Core logging and inspection

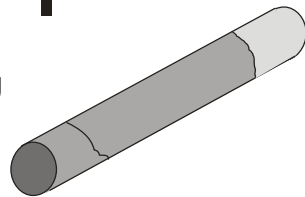

Step 3. Sample removal from core

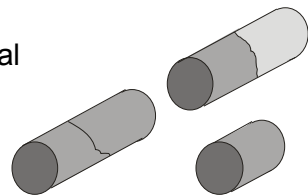

Step 4. Rock crushing

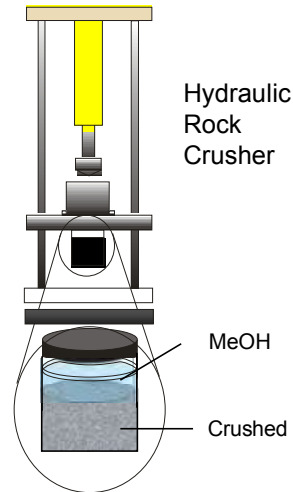

Step 5. Fill sample bottle with crushed rock and methanol

Step 6. Microwave assisted extraction (MAE)



Step 7. Analysis and conversion of results to pore water concentration

B.L. Parker (Modified from Hurley, 2002)

3-76

Notes

- ◆ Discrete Fracture Network (DFN) Approach is a process used to characterize contaminated sites on fractured rock. This approach focuses on two elements – appropriate data acquisition and evaluation of the data. Improvements in rock core analyses using the microwave assisted extraction technique has obtaining made real-time rock core contaminant concentrations a reality.

Source: B.L. Parker (modified from Hurley, 2002)

Reference

Parker, Beth L. 2011. Article 2 – The Discrete Fracture Network (DFN) Approach for Contaminated Bedrock Site Characterization. Center for Applied Groundwater Research. April.

Mass Distribution and Migration Pathway Identification

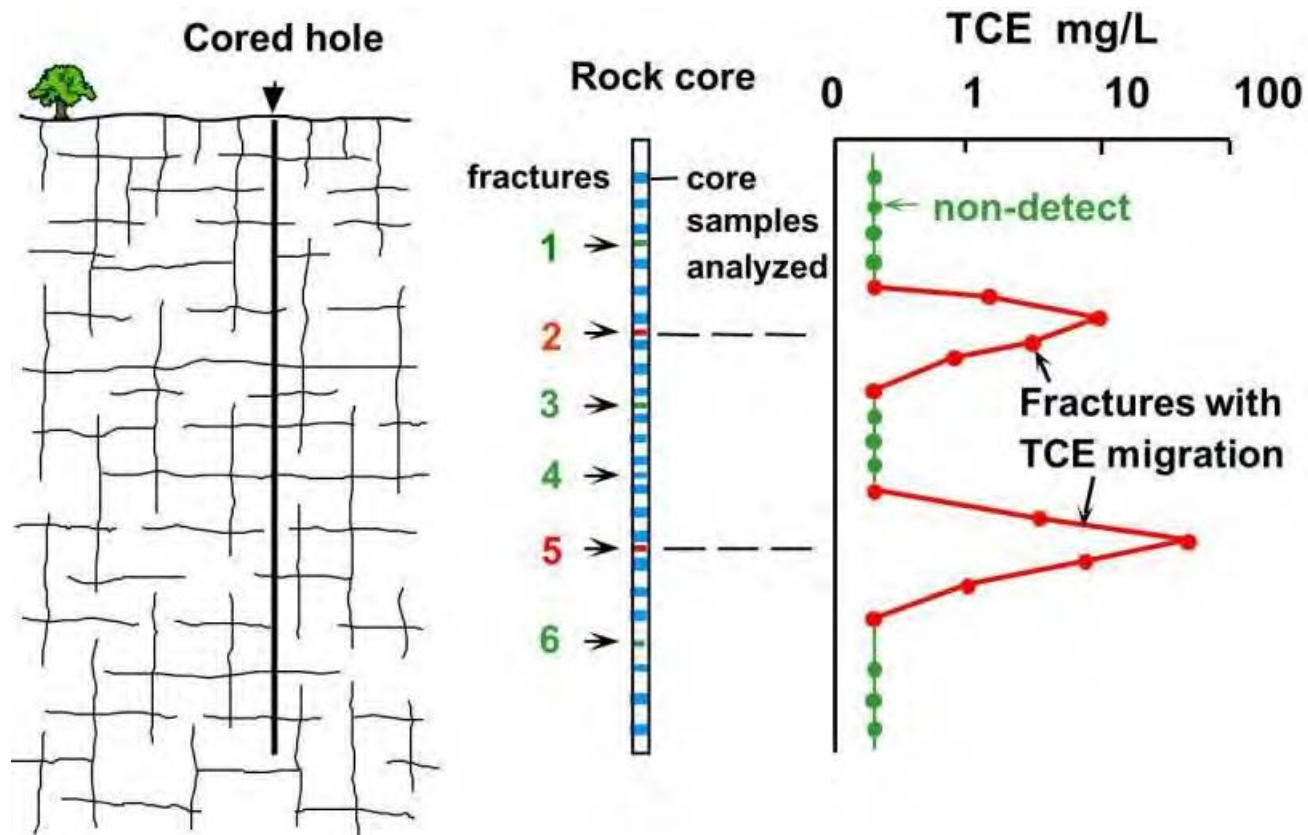

B.L. Parker

Notes



- ◆ This slide, adapted from Beth Parker, shows how rock core contaminant analysis using the DFN approach shows the distribution of contamination in the matrix.

Source: Parker, Beth L. 2011. Article 2 – Rock Core Analyses to Determine Contaminant Mass and Phase Distributions in Fractured Rock. Center for Applied Groundwater Research. April.

http://g360.uoguelph.ca/assets/PDF/Articles_1-9_2011.04.28_Final.pdf

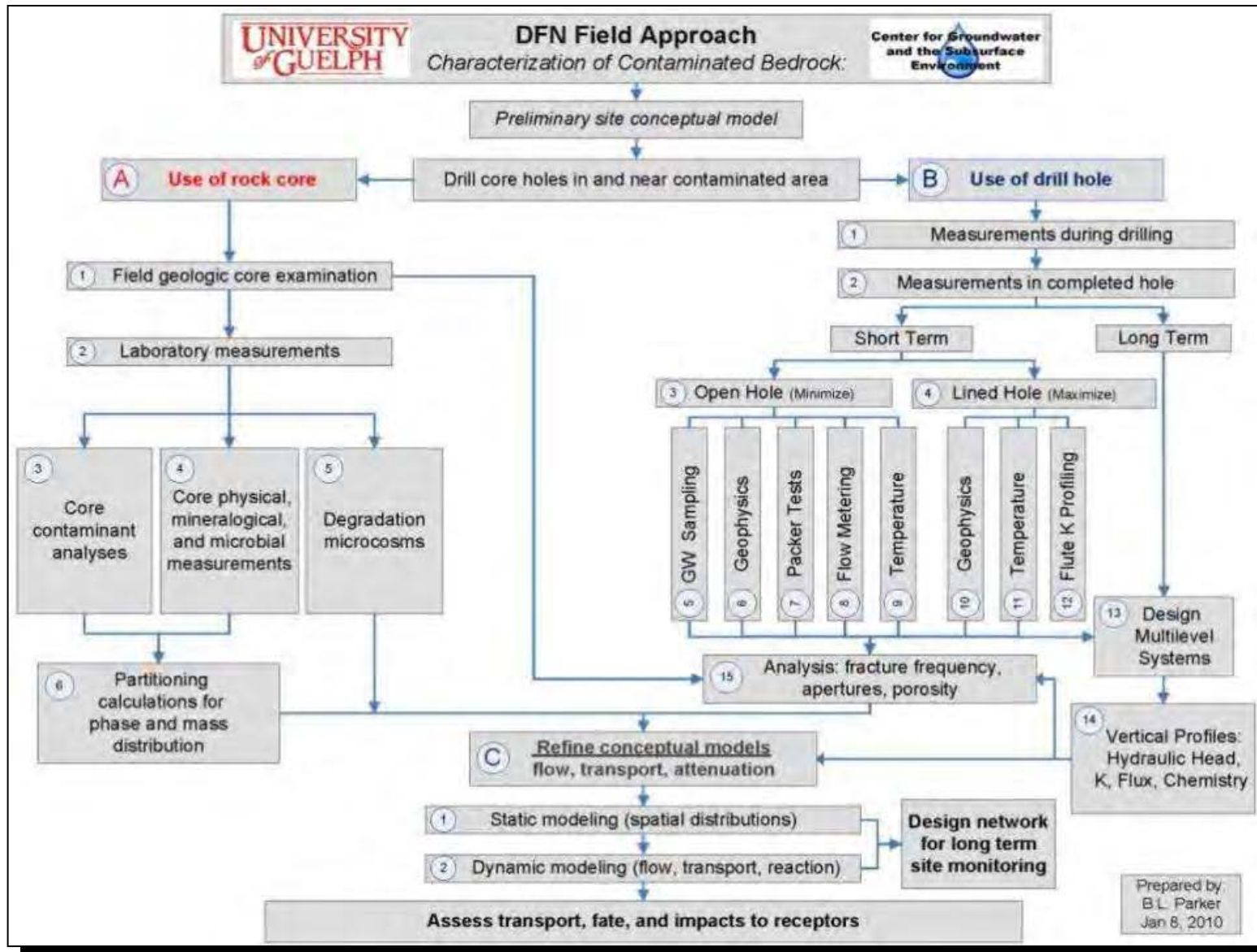

Notes

- ◆ Discrete Fracture Network (DFN) approach was summarized in a chart by Beth Parker and John Cherry from the University of Guelph. As explained in Article 1 of the DFN fact sheets:

“The chart in Figure 1 summarizes the many components of the DFN Approach. Continuous rock core obtained by diamond bit drilling is the key component, because this is used as the primary means of determining the contaminant distribution. The rock core contaminant analyses are done on small pieces of rock collected at 1 ft spacing on average along the core, which is typically drilled to 250 ft or deeper. This method represents high resolution determination of the contaminant distributions. From the starting point of rock core contaminant measurements (i.e., detailed profiles) first applied in 1997, many other high resolution field methods have been added. Each component shown in Figure 1 is a high resolution data acquisition method for improved site characterization that has recently become available.

The left side of Figure 1 displays the components pertaining to observations and measurements made using the rock core; the right side shows the types of measurements obtained from the borehole. Two elements of the DFN Approach clearly distinguish it from conventional approaches to bedrock contaminated site characterization: (1) the use of the rock core for contaminant analyses at a fine scale (Article 2) (i.e., analyses of chemicals in small pieces of the rock core selected at small spacing along the core) and (2) use of flexible-impervious liners first to seal holes to prevent cross-connection, second to measure transmissivity profiles and third to allow high resolution temperature measurements inside the water column of the lined hole to identify hydraulically active fractures without the masking effects of vertical connectivity (Articles 3 and 4).

The borehole is used primarily to collect rock core contaminant data, aimed at development of understanding of the contaminant distribution. In the DFN Approach, emphasis is directed at minimizing the length of time that the hole is left open after completion of drilling. Therefore, although the hole can be used for open-hole geophysical measurements (Article 5), such as geophysical imaging (e.g., acoustic televiewing) and hydraulic tests using straddle packers (Article 6), the time allocated to this open-hole data acquisition is purposefully limited. Furthermore, the DFN Approach avoids using data collected from partially or fully cross-connected open holes as a basis for understanding key features in the natural system.

Immediately after the hole is drilled, a liner is installed in the hole using a procedure that provides a transmissivity profile (Article 3). High resolution passive or active temperature profiling is then done inside the liner (Article 4) as a sensitive tracer of active groundwater flow in sealed (i.e., natural) conditions. The liner is removed for a short period at a later date to allow open-hole geophysical measurements (Article 5) and hydraulic tests (Article 6). Then, after the rock core and borehole data have been compiled and assessed, the liner is removed for the last time so a depth-discrete multilevel system (MLS) (Article 7) or a conventional monitoring well can be installed in the hole, from which data are then acquired. These data are used as part of the site characterization, which includes assessment of various

hypotheses and development of a robust SCM. Application of this approach at eight sites has provided a general conceptual model for the nature of contaminant plumes in fractured sedimentary rock (Article 8). After the site characterization is complete, a long-term groundwater monitoring network is established based on the DFN data sets and the SCM. The groundwater system is monitored at the appropriate locations and depths over long periods of time and provides sentry monitoring relevant to potential contaminant receptors.”

Source: Parker, Beth L. 2011. Article 2 – The Discrete Fracture Network (DFN) Approach for Contaminated Bedrock Site Characterization. Center for Applied Groundwater Research. April.

http://q360.uoguelph.ca/assets/PDF/Articles_1-9_2011.04.28_Final.pdf

In situ characterization

Flow velocity

Temperature

Passive flux

TOOLS FOR NON-DEPTH-SPECIFIC APPLICATIONS



23rd Annual NARPM Training Program

3-79

Flow Velocity Sensors

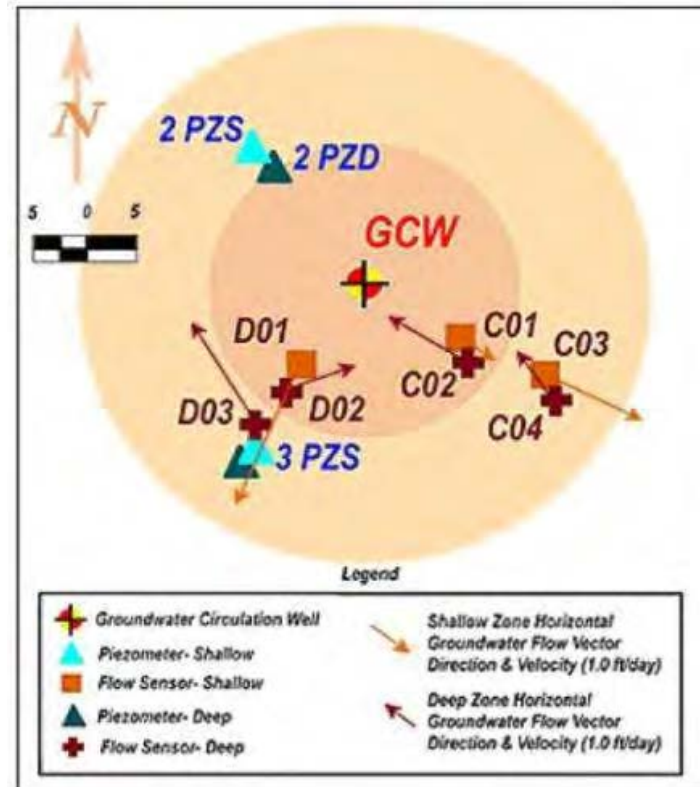
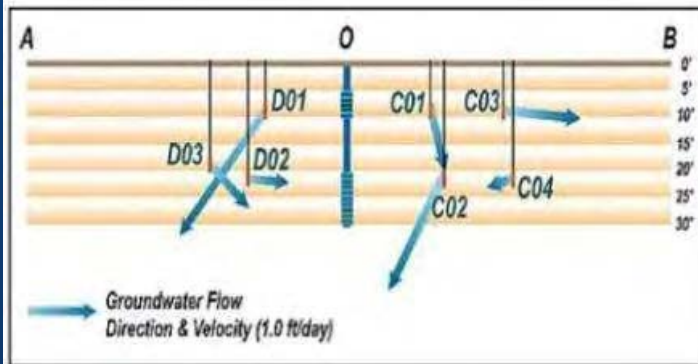
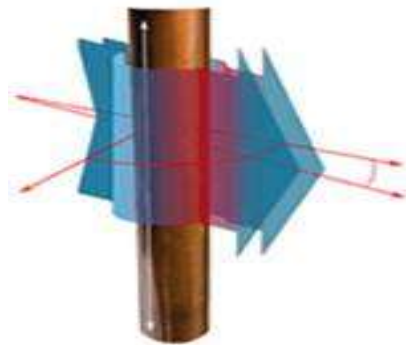

Notes



- ◆ **Aids in design of groundwater remedies:** A detailed understanding of flow direction and velocity in groundwater can aid in the design of in situ groundwater treatment remedies that involve injection of chemicals and for locating extraction and monitoring wells for a pump-and-treat system. Flow velocity sensors have been developed that use temperature to measure flow direction and velocity in groundwater. In the flow sensor shown on this slide, an integrated array of 30 carefully calibrated temperature sensors, or thermistors, records any temperature variations resulting from groundwater flowing, and thus, carrying heat over and away from the surface of the probe. These extremely sensitive thermistors can measure temperature differences to within +/-0.01 degrees Centigrade. In the presence of flowing groundwater, these thermistors will record colder temperatures on the upstream side of the probe.

The precise geometry and sensitivity of the heater/thermistor array and the very large averaged sampling volume (>1 cubic meter) of the probe allows for precision and accuracy in observing both horizontal and vertical flow vectors. Recording the compass heading of the probe reference direction then allows the user to estimate the direction of the groundwater flow to within +/-5 degrees. Of technical importance, the algorithm used to calculate flow velocities assumes several important factors, namely that (1) thermal and hydraulic properties of the surrounding lithology are homogenous and isotropic, and (2) gravitational effects are negligible. Largely because of the former, the probe is not appropriate for use in grossly heterogeneous sediments. The latter dictates that the applied heat must not result in converging groundwater, meaning that the surrounding sediment must allow groundwater to flow past the probe, rendering it useless in clays.

As with many of the techniques described in this module, the information can be used to evaluate natural and induced conditions. For example, in EPA's study under the Superfund Innovative Technology Evaluation (SITE) program, the flow sensor (shown in this slide) was used to evaluate circulation created by an in situ stripping well used to remediate volatile organics. The complete report can be found at <http://www.epa.gov/ord/SITE/reports/540r02500/540R02500prel.pdf>.

- ◆ **Helps characterize contamination horizontally and vertically:**
 - » Constrain source age, location and likely contaminant distribution based on results. Precisely establish optimum (qualitative) chemistry sampling locations for delineating plume extent.
 - » Conduct chemistry sampling using qualitative methods. Refine calculation of age and contaminant areal extent, if necessary.
 - » Establish optimum locations for quantitative chemical analysis of plume.

- » Obtain quantitative chemistry results and further constrain contaminant degradation rates and, with multiple-depth results, the 3-D positioning of density-dependent species within the aquifer.
- » Use groundwater velocity and direction measurements and qualitatively calculate the future position of specific chemistries over time using a simple spreadsheet program.

◆ **Optimizes 3 dimensional zone of influence:**

Flow rate information can be used to optimization of the 3-dimensional zone of influence for poorly performing groundwater circulation wells, air sparging systems, in situ flushing, in-well stripping, and pump and treat systems in unconsolidated, saturated sediments:

- » Refine field parameters and improve model calibration for analyzing aquifer-disturbing technology performance.
- » Directly observe effects on 3-dimensional aquifer motion by changing fluid pumping and injection rates, schedules and even directions.
- » Select optimum sampling locations and intervals based on observed travel time and direction.
- » Monitor field-scale and regional environmental contributions to induced flow vectors. Use in conjunction with existing monitoring wells to directly monitor changes to localized hydraulic anisotropies over time.
- » Optimize monitoring efficiency by performing long-term flow vector monitoring and data downloading remotely via wireless or land-line modem or satellite link.

Sensor Temperature and Flow Rate

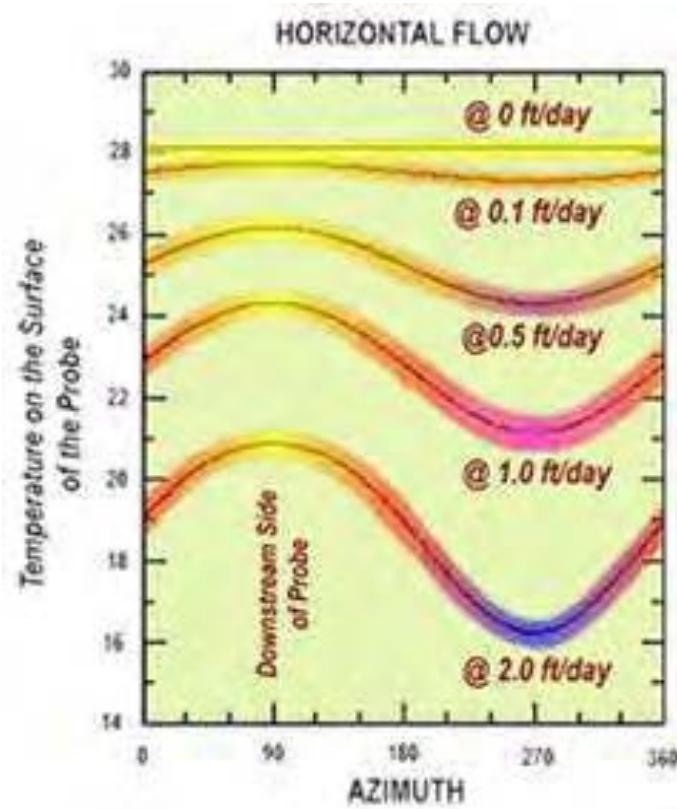

Notes



- ◆ Flow sensors have many potential applications. Some of the limitations and potential applications are shown below. All elements of this technology are made to fit within a polyvinyl chloride (PVC) pipe that is inserted within a drill pipe.
 - » **Minimum Darcy Velocity** = 0.01 ft/day (0.04×10^{-4} cm/sec)
 - » **Maximum Darcy Velocity** = 2.00 ft/day (4×10^{-4} cm/sec)
 - » **Resolution** = 0.001 ft/day (0.003×10^{-4} cm/s)
 - » **Operating Range** = 0.01 to 2.00 ft/day (0.04×10^{-4} to 7.10×10^{-4} cm/sec)
 - » **Minimum Flow Rate Measured** = 0.01 ft/day
(0.04×10^{-4} to 7.10×10^{-4} cm/sec)
 - » **Maximum Flow Rate Measured** = approximately 2 ft/day
 - » **Maximum Depth** = >1,000 feet
 - » **Thermistor Accuracy** = +/- 0.01°C
 - » **Azimuth Accuracy** = +/- 10°

Uses of Point Velocity Probes

- ◆ K is invariably uncertain (n, gradient?)
- ◆ Small areas
- ◆ High permeability aquifers
- ◆ Near boundaries
- ◆ Thin strata – discovery and characterization
- ◆ Flow through NAPL zones
- ◆ Velocity changes over time at selected locations
- ◆ Assessment of hydraulic control

Notes



- ◆ Point Velocity Probes (PVP) were developed by Professor Rick Devlin, now at the University of Kansas. These devices are emplaced directly in the aquifer medium (as opposed to being deployed in wells) for the purpose of directly measuring the direction and magnitude of the groundwater flow velocity. Devlin suggests these reasons for using PVPs or situations in which their use might be beneficial. First, knowledge of hydraulic conductivity is inherently uncertain. Often measurements of K are subject to order of magnitude error. There is also some uncertainty in our measurements of porosity and hydraulic gradient on a small scale. These variables are used to calculate seepage velocity and such calculations may compound the uncertainty of the variables in the result. Measuring the velocity directly avoids some of this uncertainty. Most velocity calculations are done over relatively large areas incorporating many wells and large plume volumes over which small scale variability is averaged out. The PVPs can provide the actual direction and magnitude over a small area of concern in which gradients might be hard to measure. Similarly, near hydraulic boundaries, one expects gradients to change with proximity to the boundary. The scale of the effect of the boundary on the flow can be assessed using PVPs. Since the scale of measurement of the PVPs is very small, they can be used to assess flow in thin strata which may have a large effect on overall transport (e.g., a thin high K layer in a lower K formation).

Devlin, J.F., et. al. Applications and Implications of Direct Groundwater Velocity Measurement at the Centimetre Scale. Journal of Contaminant Hydrology 127 (2012) 3 - 14

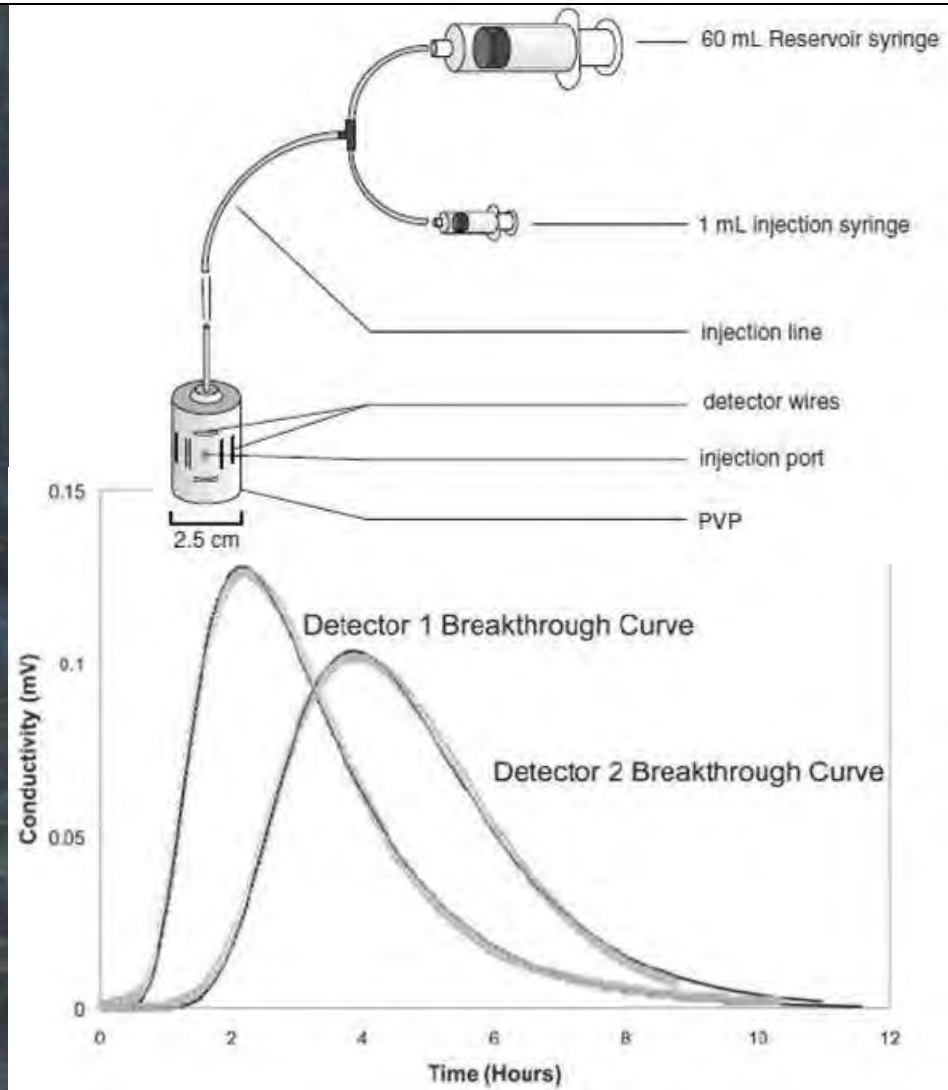

Notes

- ◆ The photo on the left shows a typical PVP monitoring zone. The multiple PVPs can be incorporated into a single 2-inch OD PVC pipe as shown here. The pairs of parallel lines arranged in a square pattern are the electrical conductivity sensors. Each line is a wire which detects changes in electrical conductivity. In the center of the square pattern is the injection port through which the electrolyte solution is injected. Groundwater flow then carries the electrolyte solution from the port and past one of the pairs of sensors where the change in conductivity is detected. The data are shown in the plot on the lower right in which breakthrough curves of electrical conductivity vs. time are shown. These curves are then matched to curves generated with a model to determine the velocity.

Mapping Velocity Changes Over Time during Enhanced Bioremediation

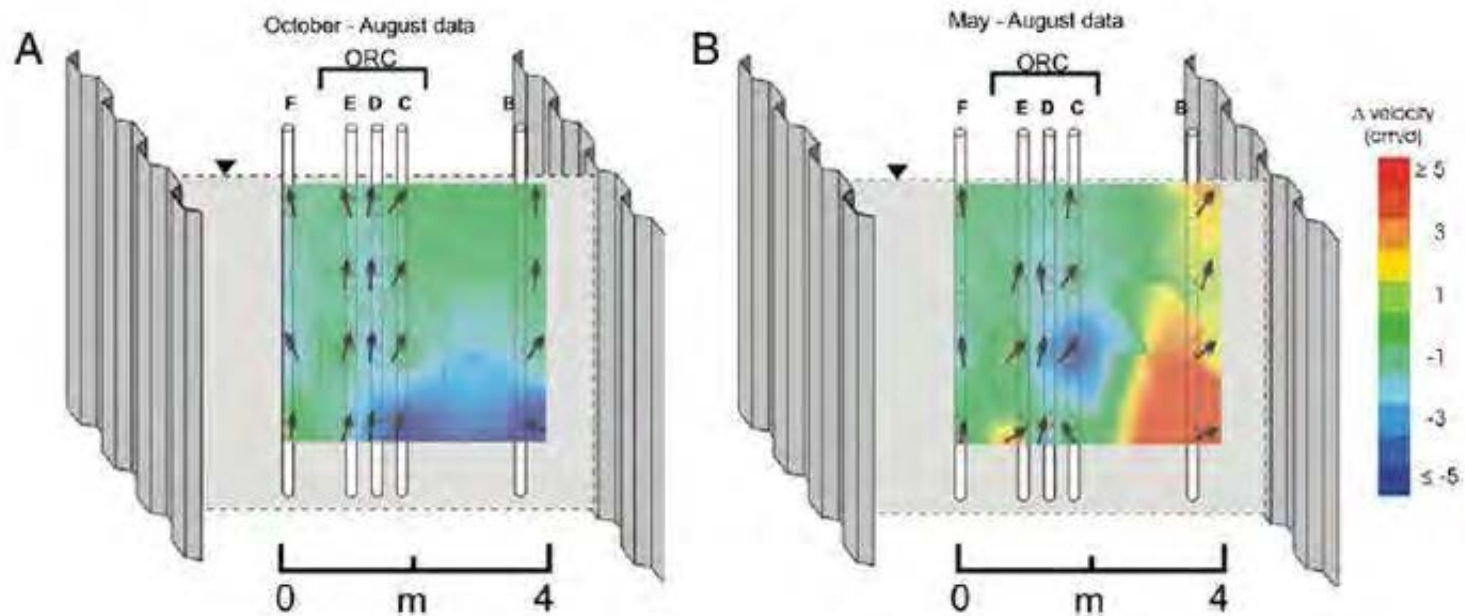

Notes

- ◆ Devlin et al. conducted an experiment on enhanced biodegradation at Canadian Forces Base Borden in Ontario. In this experiment, the groundwater plume and contaminant transport were constrained by the presence of sheet piling on either side of the plume. A transect of PVPs were installed to monitor the small scale flow velocities over time. The panel on the right shows the velocity field prior to initiating biostimulation using Oxygen Releasing Compound (ORC). A high velocity zone is clearly visible as a red area on the lower right side of the flow field. The direction of flow in this area is to the right, toward the barrier on the right. After the ORC had been in place and degradation began different velocities were measured as shown on the left. Here the zone formerly characterized by high flow velocities now has the lowest flow velocities on the transect. Devlin et al found that this change was the result of the growth and accumulation of biomass in this area resulting from the ORC biostimulation. Most of the oxygen traveled through the original high velocity layer and resulted in the growth of biomass in this area. That biomass reduced the hydraulic conductivity in this area resulting in lower flow velocities. PVPs can provide critical data on the actual performance of such remediation systems over time.

NOTE: This slide can be viewed in color in the Appendix A to this manual.

Passive Flux Meter Technology

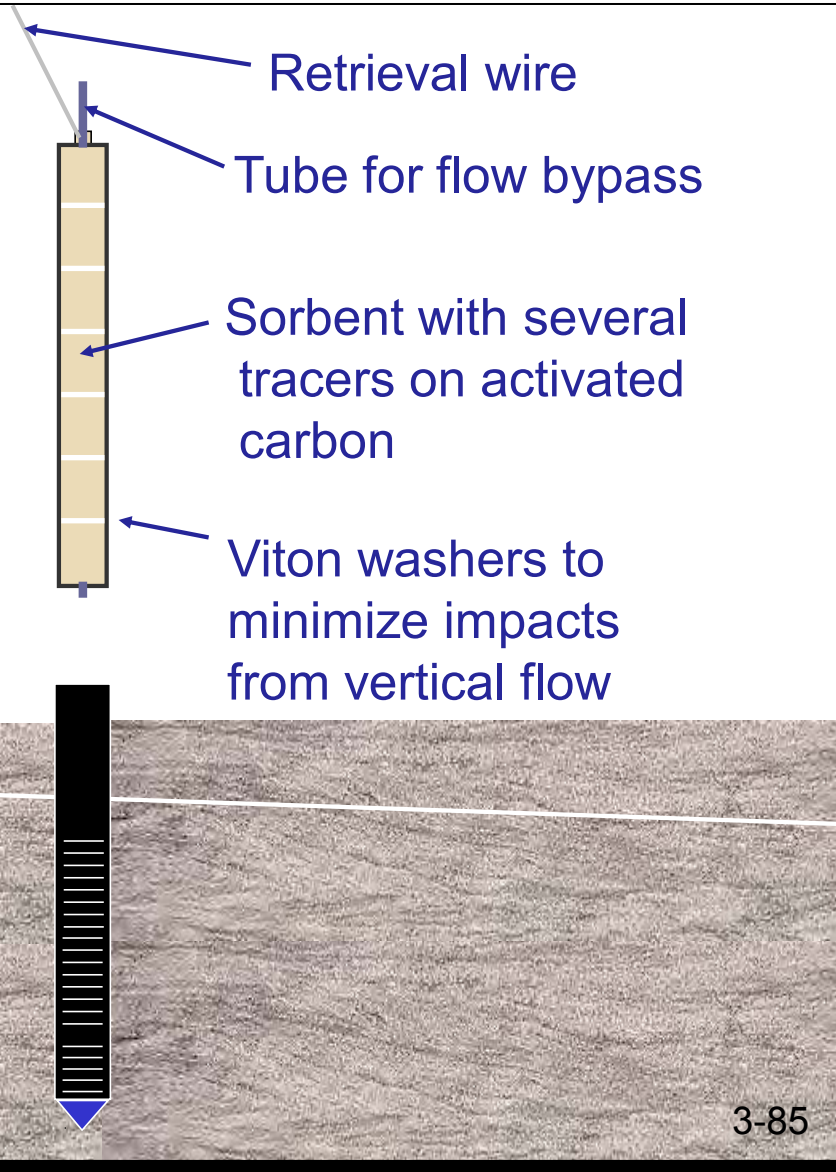

(Hatfield et al., JCH 2004)

3-85

Notes



- ◆ **Passive Flux Meter (PFM)** is a self-contained permeable unit (nylon mesh tube) that is inserted into a well or boring such that it intercepts groundwater flow but does not retain it. The interior composition of the meter is a matrix of hydrophobic and hydrophilic permeable sorbents that retain dissolved organic and inorganic contaminants present in fluid intercepted by the unit. The sorbent matrix is also impregnated with known amounts of one or more fluid soluble “resident tracers.” These tracers are leached from the sorbent at rates proportional to the fluid flux (ESTCP 2006d).

The permeable unit should be the same length as the screened interval. After a specified period of exposure to groundwater flow, the flux meter is removed from the well or boring. Next, the sorbent is carefully extracted to quantify the mass of all contaminants intercepted by the flux meter and the residual masses of all resident tracers. The contaminant masses are used to calculate cumulative and time-averaged contaminant mass fluxes, while residual resident tracer masses are used to calculate cumulative or time-average fluid flux. Depth variations of both water and contaminant fluxes can be measured in an aquifer from a single flux meter by vertically segmenting the exposed sorbent packing, and analyzing for resident tracers and contaminants. Thus, at any specific well depth, an extraction from the locally exposed sorbent yields the mass of resident tracer remaining and the mass of contaminant intercepted. Note that multiple tracers with a range of partitioning coefficients are used to determine variability in groundwater flow with depth that could range over orders of magnitude. This data is used to estimate local cumulative water and contaminant fluxes (taken directly from ESTCP 2007).

Source:

[http://www.clu-in.org/characterization/technologies/default.focus/sec/Passive
\(no%20purge\) Samplers/cat/Integrating Samplers/](http://www.clu-in.org/characterization/technologies/default.focus/sec/Passive(no%20purge)Samplers/cat/IntegratingSamplers/)

Limitations and Applications of Passive Flux Meter

- ◆ Sizing well bores to actual flow conditions
- ◆ Measuring groundwater and contaminant flux

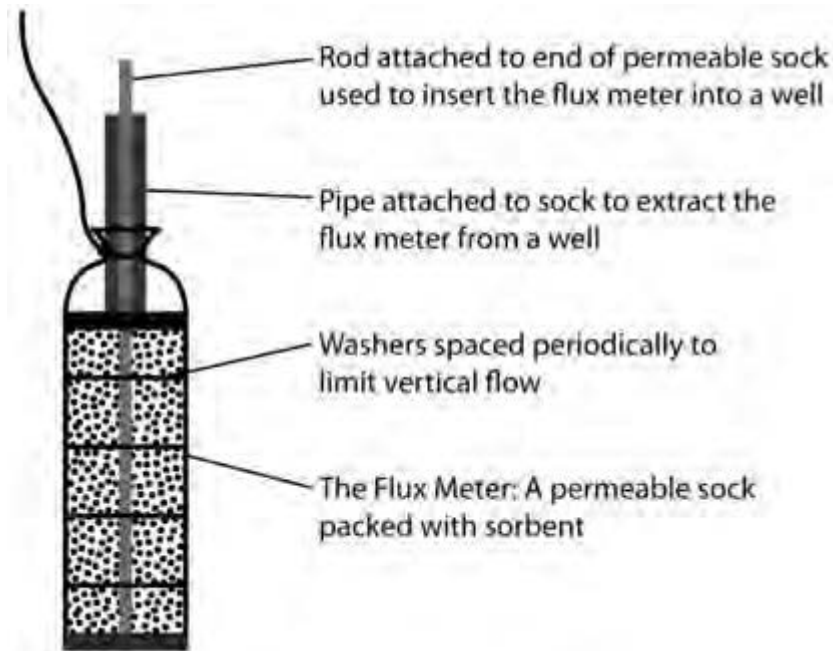

Notes



- ◆ **Sizing well bores to actual flow conditions:** The size of the well bore and the associated PFM may be optimized for the flow conditions present at a site. For example, smaller-gauge wells and longer deployment times may be more desirable in low-flow conditions. Conversely, under higher flow conditions, larger-gauge wells and shorter deployment times may be optimal. The PFM technology is most useful in areas where the horizontal gradient is significantly greater than the vertical gradient because the PFM is installed in a vertical orientation within the well bore, and the direction of flow must be perpendicular to the well orientation so that the tracers and contaminants flow through the PFM (horizontally) rather than along it (vertically). The importance of understanding vertical and horizontal flow gradients is another example of where scale-appropriate, high-resolution site characterization can be beneficial (determining the existence of vertical flow gradients along the proposed length of a monitoring well screen).
- ◆ **Measuring groundwater and contaminant flux:** Several considerations are necessary for accurate measurement of groundwater and contaminant mass flux:
 - » The PFM sorbent must intercept and retain the contaminant from the groundwater flowing through the PFM.
 - » The contaminant must be extractable from the sorbent, or analysis of the sorbed state must be possible, to quantify the mass captured.
 - » The contaminant must not degrade while inside the PFM, either in passing through the PFM membrane or while sorbed to the sorbent material.
 - » Transport must be primarily advective, meaning that the contaminants and tracers move with the solvent as it flows. This type is in contrast to diffusive flow, where the contaminant or tracer may diffuse across a concentration gradient more rapidly than the groundwater flows. Diffusive flow becomes more important at lower groundwater flow rates. Groundwater fluxes may be overestimated in a situation where diffusive flow is significant because tracers may diffuse away from the PFM in all directions rather than being carried away from the PFM in a uniform direction by the advective groundwater flow. Likewise, contaminant fluxes may be overestimated because the contaminants may migrate to the PFM from all directions rather than being carried to it in one uniform direction.
 - » Tracer desorption must be linear, reversible and instantaneous.
 - » The specific discharge within the bounds of the sorbent must be uniform, horizontal and in a direction parallel to local groundwater flow.

Many different contaminants under most common hydrogeologic conditions are expected to meet the conditions stated above. However, verifying the satisfaction of these conditional statements can be a challenge under some conditions (for example, under fractured flow or where vertical gradients are dominant driving forces [such as in carbonate or karsts topography or in mountainous terrains]).

Source: Field Demonstration and Validation of a New Device for Measuring Water and Solute Fluxes at Naval Base Ventura County (NBVC), Port Hueneme, CA ESTCP (Environmental Security Technology Certification Program), 112 pp, 2006d, <http://www.clu-in.org/characterization/technologies>

Case Example – Passive Flux Meter Results

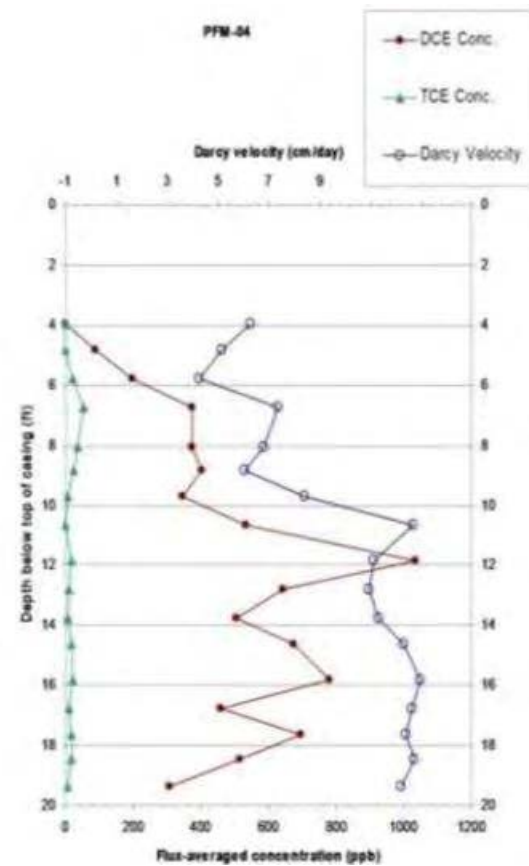
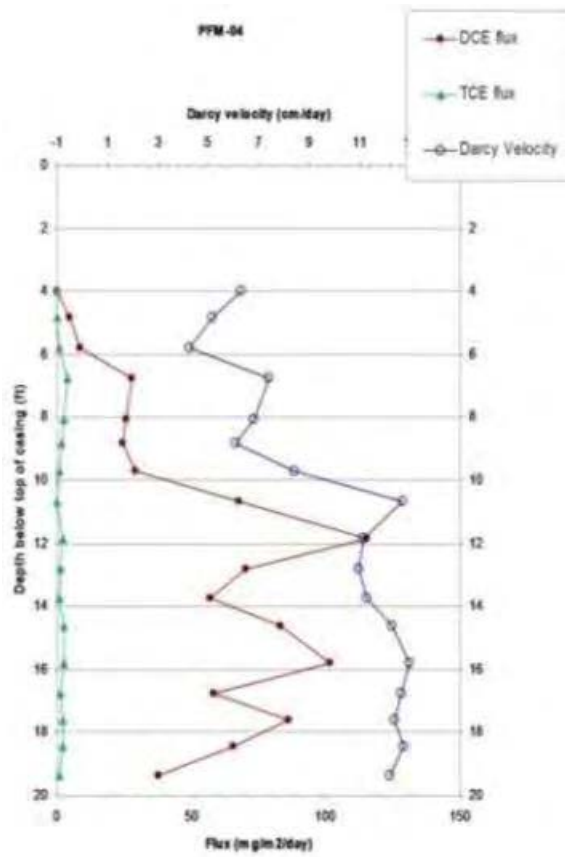

Notes

- ◆ In this slide, results for the flux meter deployments at the Parris Island U.S. Marine Corps training facility are shown. In this study, flux was found to vary dramatically in an apparently homogeneous fine sand environment. It is important not to underestimate hydrogeologic heterogeneity because of its direct relationship on the distribution of contamination. Massively bedded sands are frequently and erroneously assumed to behave in a homogeneous manner, when in fact, significant heterogeneity exists within such formations. As a result, designs that do not address heterogeneity effectively frequently lead to remedies that are less than optimal in their performance.

Various considerations impact the application of PFM technology as presented below.

Polyethylene Diffusion Bag Samplers

- ◆ Uses
- ◆ Advantages
- ◆ Disadvantages



A: Diffusion Bag with Polyethylene Mesh
B: Diffusion Bag Without Mesh
C: Diffusion Bag and Mesh Attached to Bailer Bottom

Notes

- ◆ **Uses:** Flow sensors have many potential applications. Some of the limitations and potential applications are shown below. All elements of this technology are made to fit within a polyvinyl chloride (PVC) pipe that is inserted within a drill pipe.

The suggested application of the method is for long-term monitoring of VOCs in groundwater wells at well characterized sites (Vroblesky 2001). The decision to use PDBs at a site should be done on a well-by-well basis.

PDBs also have been used to sample VOCs in groundwater discharging to surface water (Lyford 2000). Care must be taken to ensure they are placed in a gaining reach of the surface water sediment.

- ◆ **Advantages:** These advantages are adapted from Vroblesky, 2001:
 - » PDB samplers have the potential to eliminate or substantially reduce the amount of purge water associated with sampling.
 - » PDB samplers are inexpensive.
 - » The samplers are easy to deploy and recover.
 - » Because PDB samplers are disposable, there is no downhole equipment to be decontaminated between wells.
 - » A minimal amount of field equipment is required.
 - » Multiple PDB samplers, distributed vertically along the screened or open interval can be used in conjunction with borehole flow meter testing to gain insight on the movement of contaminants into and out of the well screen or open interval or to locate the zone of highest concentration in the well.
 - » Because the pore size of LDPE is only about 10 angstroms or less, sediment does not pass through the membrane into the bag. Thus, PDB samplers are not subject to interferences from turbidity.
- ◆ **Limitations:** These limitations are adapted from Vroblesky, 2001:
 - » Not effective for inorganics, SVOCs and some VOCs.

- » PDB samplers integrate concentrations over time. This can be a limitation if the goal of sampling is to collect a representative sample at a point in time in an aquifer where VOC-concentrations substantially change more rapidly than the samplers equilibrate.
- » VOC concentrations in PDB samplers represent groundwater concentrations in the vicinity of the screened or open well interval that move to the sampler under ambient flow conditions. This is a limitation if the groundwater contamination lies above or below the well screen or open interval, and requires the operation of a pump to conduct contaminants into the well for sampling.
- » If the well screen is less permeable than the aquifer or the sandpack, then under ambient conditions, flow lines might be diverted around the screen. Such a situation might arise from inadequate well development or from iron bacterial fouling of the well screen. In this case, the VOC concentrations in the PDB samplers might not represent concentrations in the formation water because of inadequate exchange across the well screen.
- » In wells with screens or open intervals with stratified chemical concentrations, the use of a single PDB sampler set at an arbitrary (by convention) depth might not provide accurate concentration values for the most contaminated zone.
- » Regulatory agencies may ask for a show of equivalency before approving the use of PDB samplers.

Source:

[http://www.clu-in.org/characterization/technologies/default.focus/sec/Passive
\(no%20purge\)_Samplers/cat/Integrating_Samplers/](http://www.clu-in.org/characterization/technologies/default.focus/sec/Passive(no%20purge)_Samplers/cat/Integrating_Samplers/)

Contaminant flux assessment
Discharge zone evaluation
Sediment characterization

TOOLS FOR THE GROUNDWATER – SURFACE WATER INTERFACE



23rd Annual NARPM Training Program

3-89

Example of GW – SW Interface Characterization

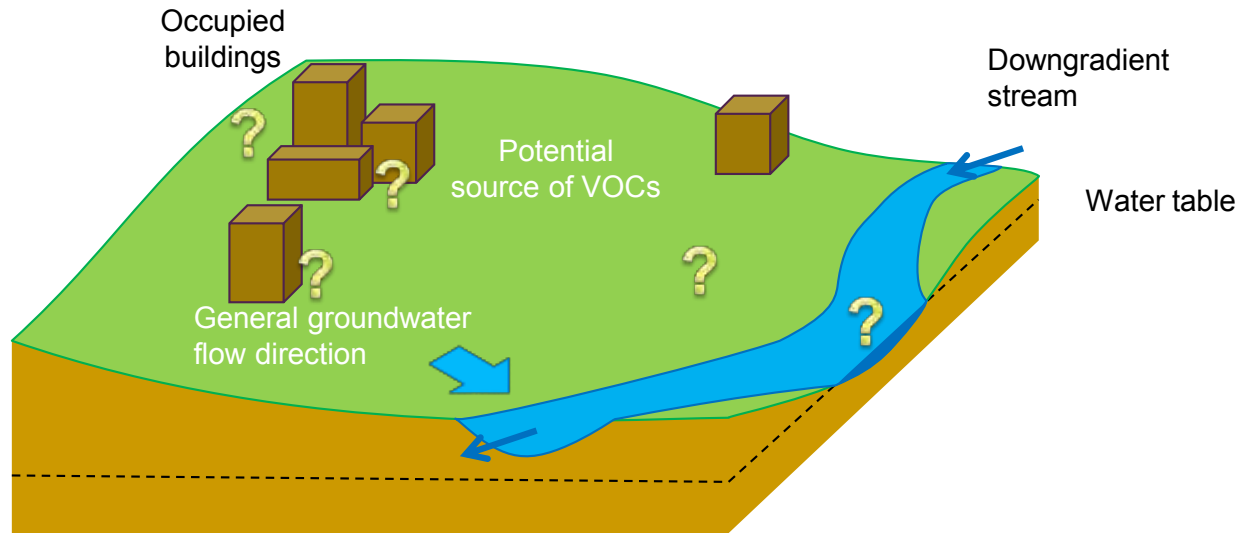

Site Background:

- VOCs in soil and overburden groundwater known, but not characterized
- Possible surface water contamination; indoor air quality concerns
- Site has potential source area, occupied buildings and downgradient stream

Notes



- ◆ This slide shows a fictitious site with the following conditions:
 - » VOCs are present in soil and overburden groundwater, but not characterized.
 - » Possible surface water contamination and indoor air quality concerns.
 - » Site has potential sources, occupied buildings and stream located downgradient of groundwater flow.

Identifying Gaining and Losing Stream Segments

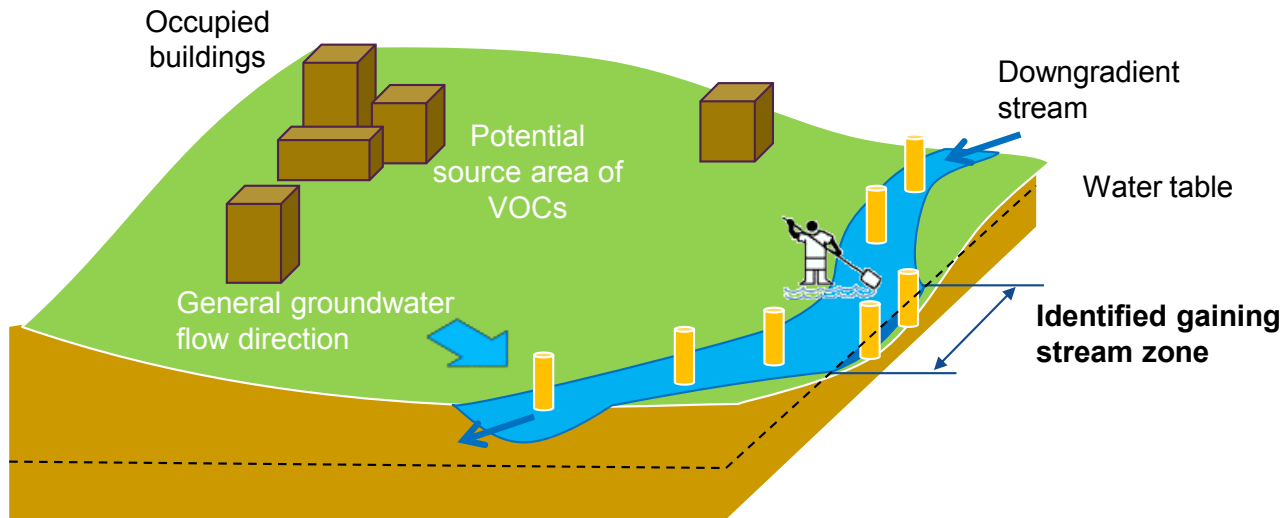

Step 1: Gaining/losing stream assessment

- Determine whether groundwater discharges to stream
- Delineate length of gaining area in stream

 Drive-point piezometer

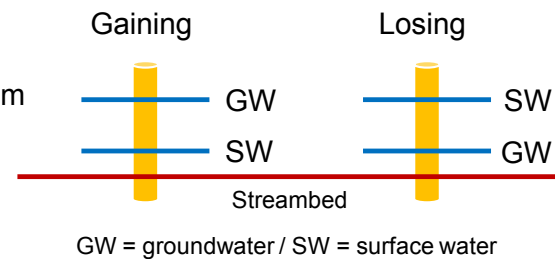

Notes



- ◆ **Mini-piezometers to determine gaining and losing reaches of river:** Mini-piezometers can be used to conduct a simple gaining-losing stream assessment. With this approach, polyvinyl chloride (PVC) piping or push point (Henry) samplers are driven into and below the stream bed. The tests will show where the stream is receiving groundwater contributions by virtue of the hydraulic head differentials between the water inside the PVC pipe and in the immediately surrounding stream. Water quality parameters such as dissolved oxygen, oxidation reduction potential (ORP), pH, conductivity, salinity, resistivity and total dissolved solids (TDS) can be quickly evaluated in the field to ensure that the samplers are in contact with representative groundwater or surface water during this type of assessment.

Measuring Fluid and Contaminant Flux

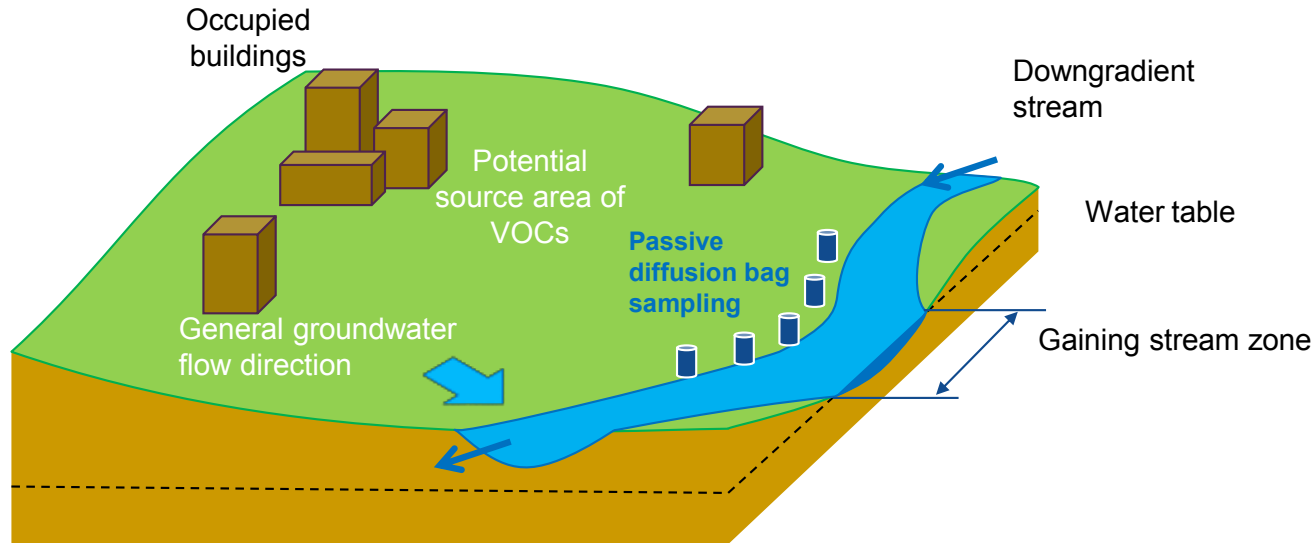

Step 2: Passive diffusion bag sampling and analysis of pore water

- Confirm whether VOCs are discharging to stream
- Focused on gaining area of stream at groundwater-sediment interface

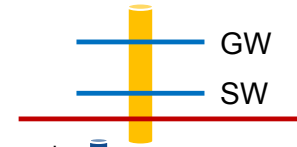

Passive diffusion bag sampler

GW = groundwater / SW = surface water

Notes



- ◆ The seepage rate to gaining streams can be measured using a passive flux meter. The contaminant concentrations in the seepage can be measured using passive diffusion bag samplers. The corresponding analytical results of this testing will identify whether contaminants are entering the stream, and if so, where along the stream they are entering.

Example of Media-Sequenced Site Characterization

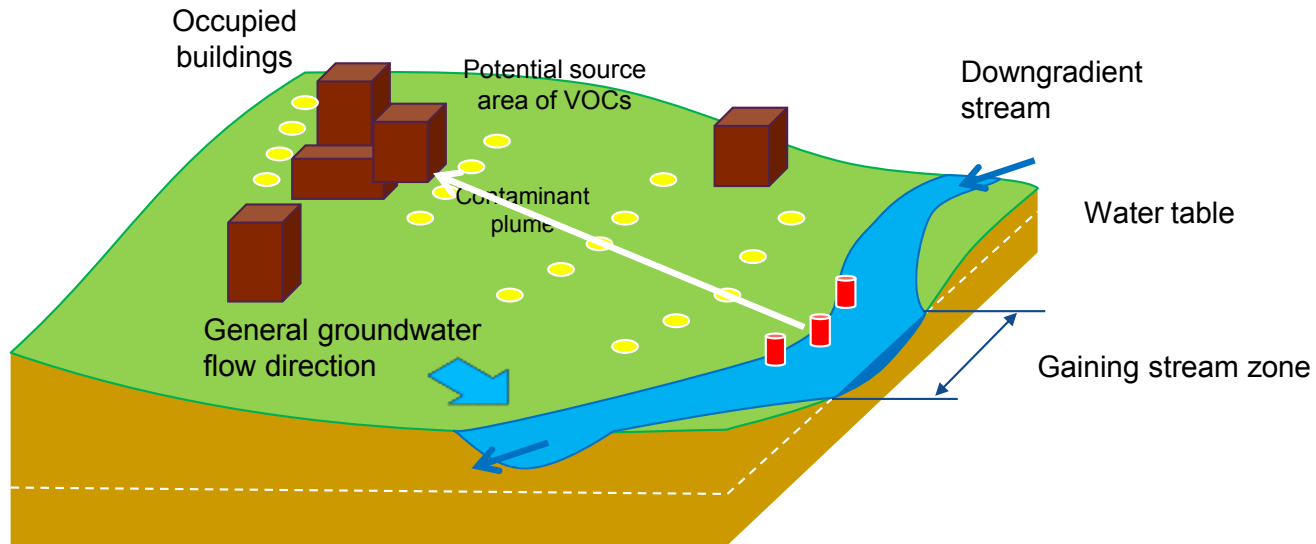

Step 3: Vertical groundwater profiling

- Transects normal to groundwater flow
- Located between stream and suspected sources; also upgradient of suspected source
- Identify plume and plume core
- Project from stream locations through plume and plume core to location of sources

Notes

- ◆ **Step 3 – Vertical groundwater profiling:** Based on the stream assessment results, Step 3 would include one or more transects of vertical groundwater profiling performed in a direction normal to groundwater flow, located between the stream and suspected upgradient sources. Using on-site analytics, data gathered in real time could be used to develop one or more 2-D cross-sections to illustrate the attitude of the plumes and plume cores. Again, updating the Characterization CSM in real-time, correlations could be made between the locations of the plume cores and the gaining stream data to provide directional feedback as to where the sources is or might be.

Example of Media-Sequenced Site Characterization

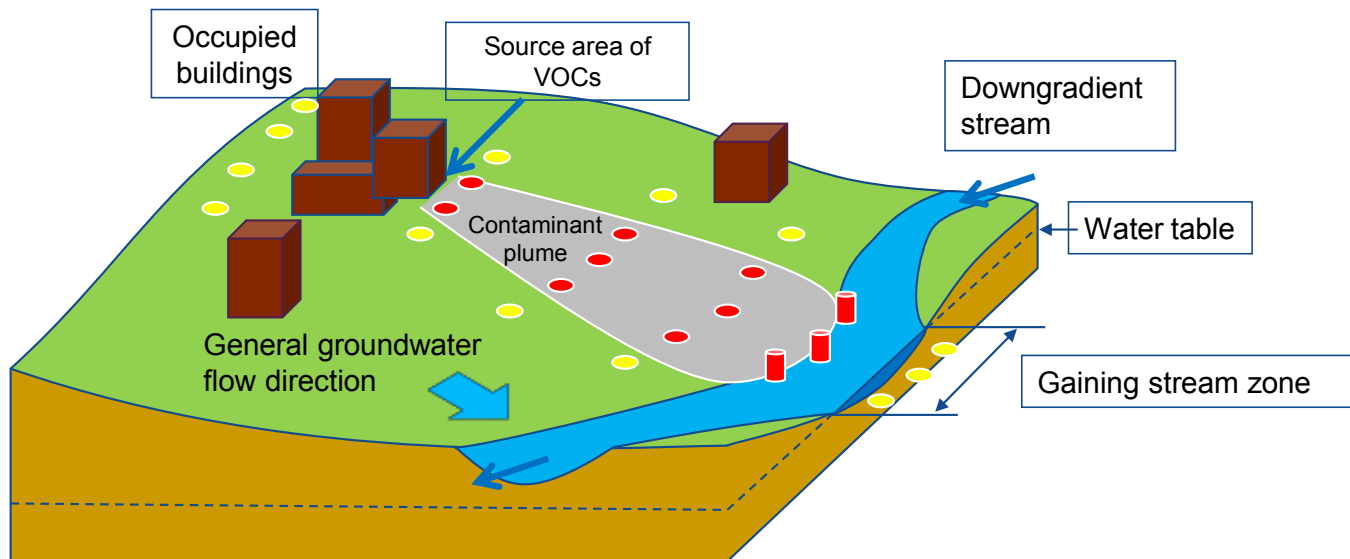

Step 4: Additional vertical groundwater profiling

- Confirm source areas and delineate plume
- Confirm whether plume flows under and past stream
- Continue profiling until downgradient extent bounded
- Update the CSM

Notes



- ◆ **Step 4 – Additional vertical groundwater profiling:** Step 4 would include additional vertical profiling transects to confirm the source and delineate the full extent of the plume, including on the downgradient side of the stream to ensure no contaminant underflow. If underflow is confirmed, additional profiling would be needed to delineate the downgradient extent.

Example of Media-Sequenced Site Characterization

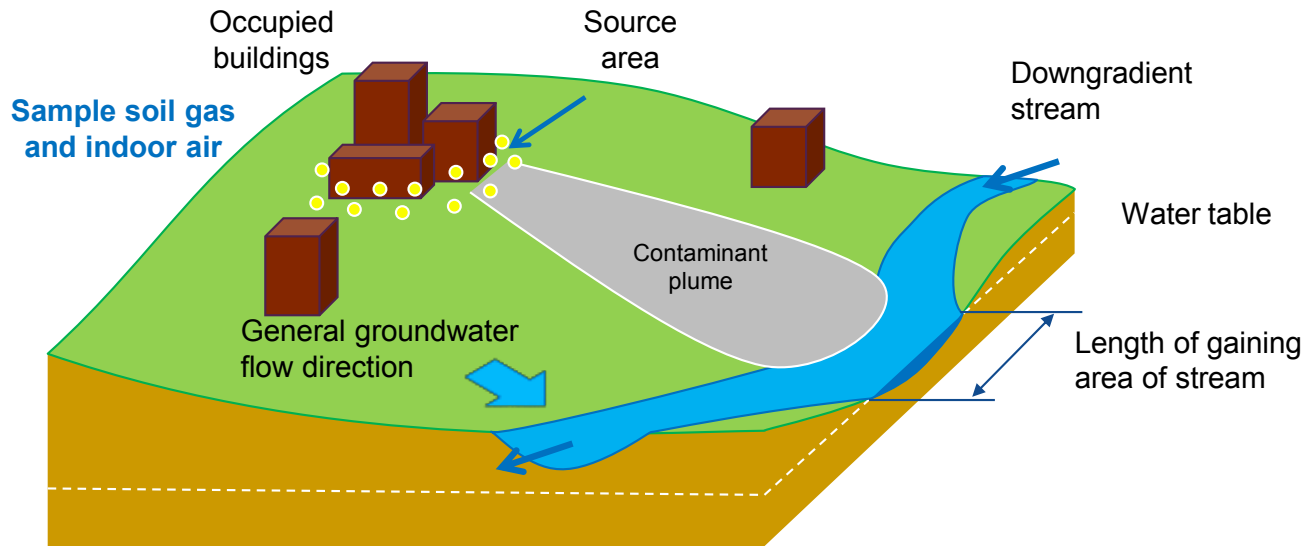

Step 5: Vapor intrusion evaluation

- Sample soil gas adjacent to buildings near sources and plume
- Take appropriate actions to sample indoor air as applicable

Notes

- ◆ **Step 5 – Vapor intrusion evaluation:** If the occupied buildings are located close enough to the delineated plume areas, soil gas sampling could be performed to determine whether there might be vapor intrusion concerns that warrant additional, prescribed actions to decide whether VOCs are entering the buildings and thus pose imminent or long-term risks to the occupants.

Pushpoint Sampler

2 Pushpoint Sampling for Defining Spatial and Temporal Variations in Contaminant Concentrations in Sediment Pore Water

A. Pushpoint sampler. Rod lengths used were 91 centimeters and 183 centimeters.



B. Point head detail. Screen is 4 centimeters wide. Tube diameter is 6.4 millimeters.

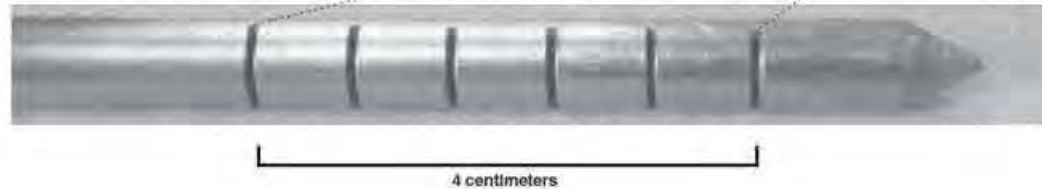

Figure 1. A, the 91-centimeter-long PushPoint Extreme Sampler, and B, closeup of the slotted screen at the tip.

Notes



- ◆ The pushpoint sampler is a small diameter (about 6 millimeters) stainless steel tube with a machined point and a slotted screen zone (about 4 centimeters) at the tip. An internal guard rod positioned through the bore adds rigidity to the sampler during insertion. After setting the pushpoint sampler in the sediment at the desired depth, the guard rod is withdrawn. The PPS is designed to sample pore water with minimal disturbance to the site. A pump can then be used to draw water samples through the pushpoint sampler.

» Advantages:

- Only one site visit is needed to collect one or more samples
- Many samples can be collected easily to define discharge zones laterally and vertically
- No onsite installation of equipment is required
- Substrate disturbance is minimal
- Differential heads (water levels) can be measured easily with a manometer

» Limitations:

- A sample represents conditions at a point in time and space, not an integration of changes over a longer time period
- Without semi-permanent installation (i.e., multilevel sampler), a sample may not be drawn from the identical spot on return visits
- The physical characteristics of the substrate may prevent sample collection
- Low yield can make it difficult to obtain flow sufficient for measurement of field properties.

Source: Zimmerman, M. J., Massey, A.M. and Campo, K.W. 2005. Pushpoint Sampling for Defining Spatial and Temporal Variations in Contaminant Concentrations in Sediment Pore Water near the Ground-Water/Surface-Water Interface. U.S. Geological Survey Scientific Investigations Report 2005-5036, 70 pages.

Sediment and Benthic Organism Assessments

- ◆ Sediment sampling
 - Contaminant concentrations
 - Oxidizing or reducing environment
- ◆ Benthic macroinvertebrate community survey
 - Assess species population and diversity
 - Compare potentially impacted locations to control stations

Notes

- ◆ **Sediment sampling:** Sediment core sampling in the gaining area of the stream will indicate how the sediment is being impacted, and whether the nature of the sediments (oxidizing or reducing) will affect contaminant concentrations. Reducing sediments may attenuate metals concentrations in discharging groundwater.
- ◆ **Benthic macroinvertebrate community survey:** Characterize the potential ecologic receptor impacts at the exposure point for groundwater discharge (if no detectable benthic impact, may obviate the need for extensive characterization).

Enumerate benthic macroinvertebrate community at discrete sampling stations.

Compare species diversity and population to the observed benthic macroinvertebrate community at control stations in areas not impacted by the site. Assess statistically the difference between the site and the control to help assess site impacts.

GROUNDWATER/SURFACE WATER INTERACTION



23rd Annual NARPM Training Program

3-98

Groundwater plume discharge into surface water is spatially complex

Brewster Conant Jr., John A. Cherry, Robert W. Gillham
Journal of Contaminant Hydrology 73 (2004) 249-279*



Available online at www.sciencedirect.com

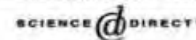

Journal of Contaminant Hydrology 73 (2004) 249–279

JOURNAL OF
**Contaminant
Hydrology**

www.elsevier.com/locate/jconhyd

A PCE groundwater plume discharging to a river: influence of the streambed and near-river zone on contaminant distributions

Brewster Conant Jr.*, John A. Cherry, Robert W. Gillham

Department of Earth Sciences, University of Waterloo, 200 University Avenue West, Waterloo, Ontario Canada N2L3G1

Received 6 November 2003; received in revised form 1 April 2004; accepted 1 April 2004

Abstract

An investigation of a tetrachloroethene (PCE) groundwater plume originating at a dry cleaning facility on a sand aquifer and discharging to a river showed that the near-river zone strongly modified the distribution, concentration, and composition of the plume prior to discharging into the surface water. The plume, streambed concentration, and hydrogeology were extensively characterized using the Waterloo profiler, mini-profiler, conventional and driveable multilevel samplers (MLS), Ground Penetrating Radar (GPR) surveys, streambed temperature mapping (to identify discharge zones), drivepoint piezometers, and soil coring and testing. The plume observed in the shallow streambed deposits was significantly different from what would have been predicted based on the characteristics of the upgradient plume. Spatial and temporal variations in the plume entering the near-river zone contributed to the complex contaminant distribution observed in the streambed where concentrations varied by factors of 100 to 5000 over lateral distances of less than 1 to 3.5 m. Low hydraulic conductivity semi-confining deposits and geological heterogeneities at depth below the streambed controlled the pattern of groundwater discharge through the streambed and influenced where the plume discharged into the river (even causing the plume to spread out over the full width of the streambed at some locations). The most important effect of the near-river zone on the plume was the extensive anaerobic biodegradation that occurred in the top 2.5 m of the streambed, even though essentially no biodegradation of the PCE plume was observed in the upgradient aquifer. Approximately 54% of the area of the plume in the streambed consisted solely of PCE transformation products, primarily *cis*-1,2-dichloroethene (cDCE) and vinyl chloride (VC). High concentrations in the interstitial water of the streambed did not correspond to high groundwater-discharge zones, but instead occurred in low discharge zones and are likely sorbed or retarded remnants of past high-concentration plume discharges. The high-concentration areas (up to 5529 µg/



23rd Annual NARPM Training Program

3-99

Notes



- ◆ This paper by Conant et al., describes very detailed research into the nature of the discharge of a PCE plume from a sandy aquifer into a small river in Ontario, CA. The results of the research show that the discharge of groundwater into the river is spatially very complex and depends on the subsurface geology more than on the stream bed makeup or topography. The research involved the use of many techniques to assess both volumetric flux of groundwater into the stream as well as mass discharge of the plume into the stream.

Pine River Research – Angus, Ont.



Notes



- ◆ This aerial photo shows the location of the dry cleaning establishment where the PCE release occurred along with Pine River reach where Conant did his research. The site is located in the small town of Angus, Ontario near Canadian Forces Base Borden, and was the location of several research projects undertaken by the University of Waterloo.

Pine River Study Site

(a) Site Map

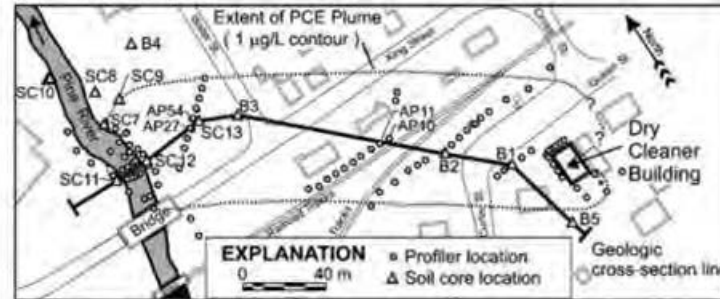

(b) Geological Cross-Section

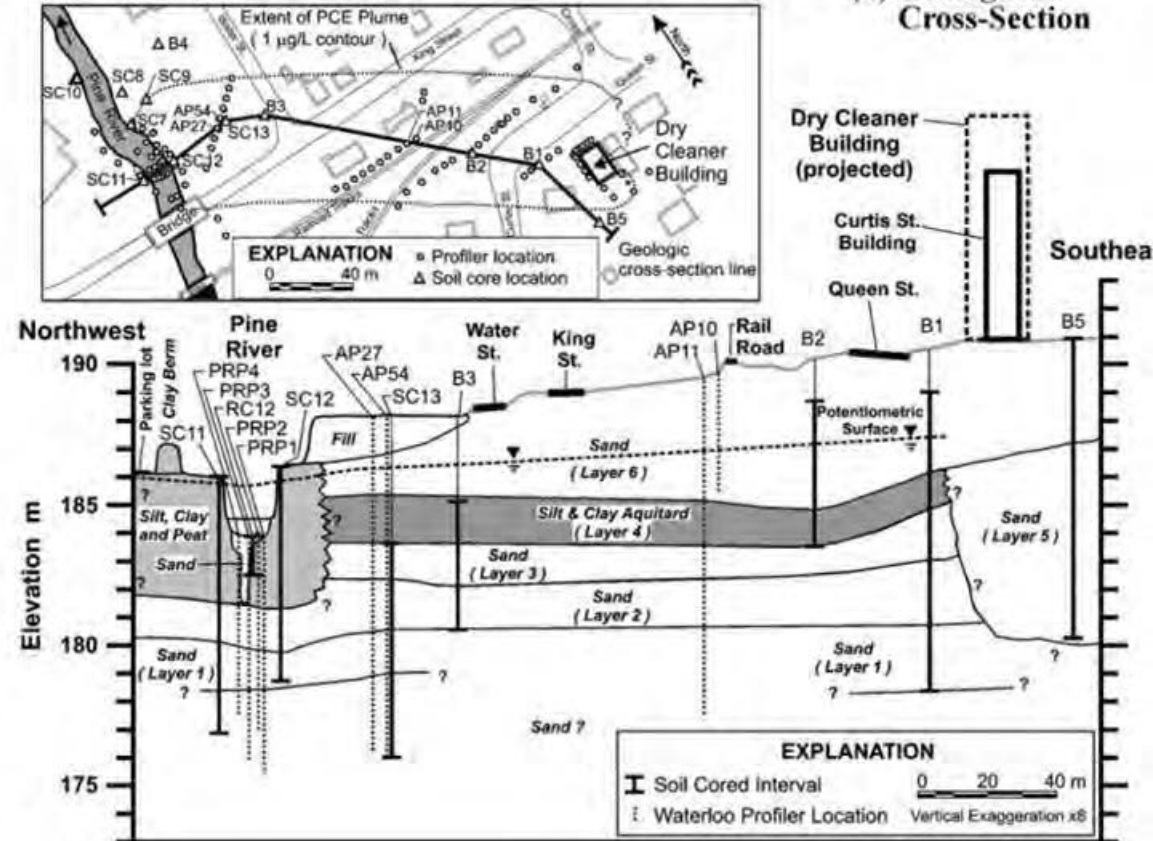

Brewster Conant Jr. *, John A. Cherry, Robert W. Gillham
Journal of Contaminant Hydrology 73 (2004) 249- 279



Notes



- ◆ The upper box shows the site layout including the dry cleaner location, the approximate plume boundary and centerline, several waterloo profiler transects and the reach of the Pine River where the research was undertaken. The lower box is a generalized cross section showing the geology of the aquifer. The release occurred at the dry cleaner building on the right where a stream had cut down through the silt and clay aquitard with sand above and below. The plume existed below the aquitard and ultimately discharged to the Pine River on the left side of the diagram.

Pine River Research Site

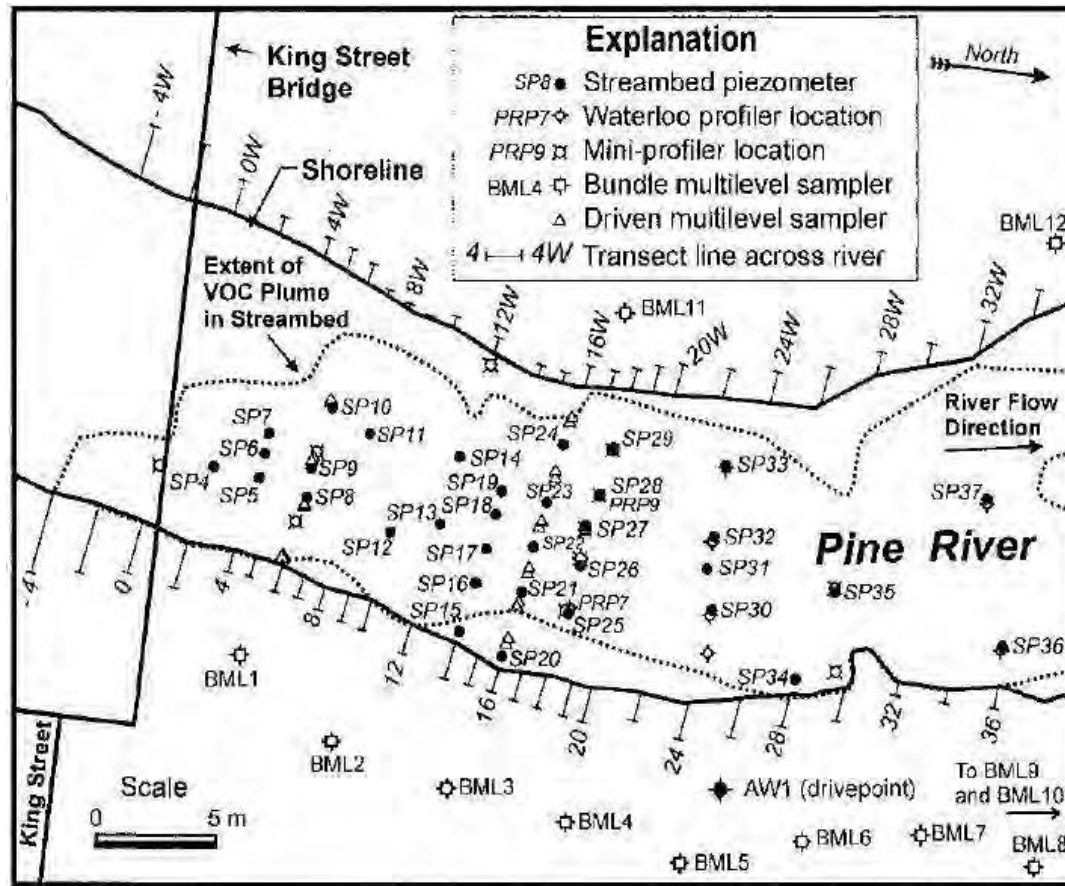

Conant et al., 2004

Notes



- ◆ This Diagram from Conant et al., shows the high resolution network of investigation points over the fairly short reach in which the plume discharged to the stream. Tools used include streambed piezometers, waterloo profiler, mini-piezometers, multi-level bundle piezometers, and driven multi-level piezometers, ground penetrating radar and surface water and multiple depth temperature profiles beneath the streambed were also undertaken.

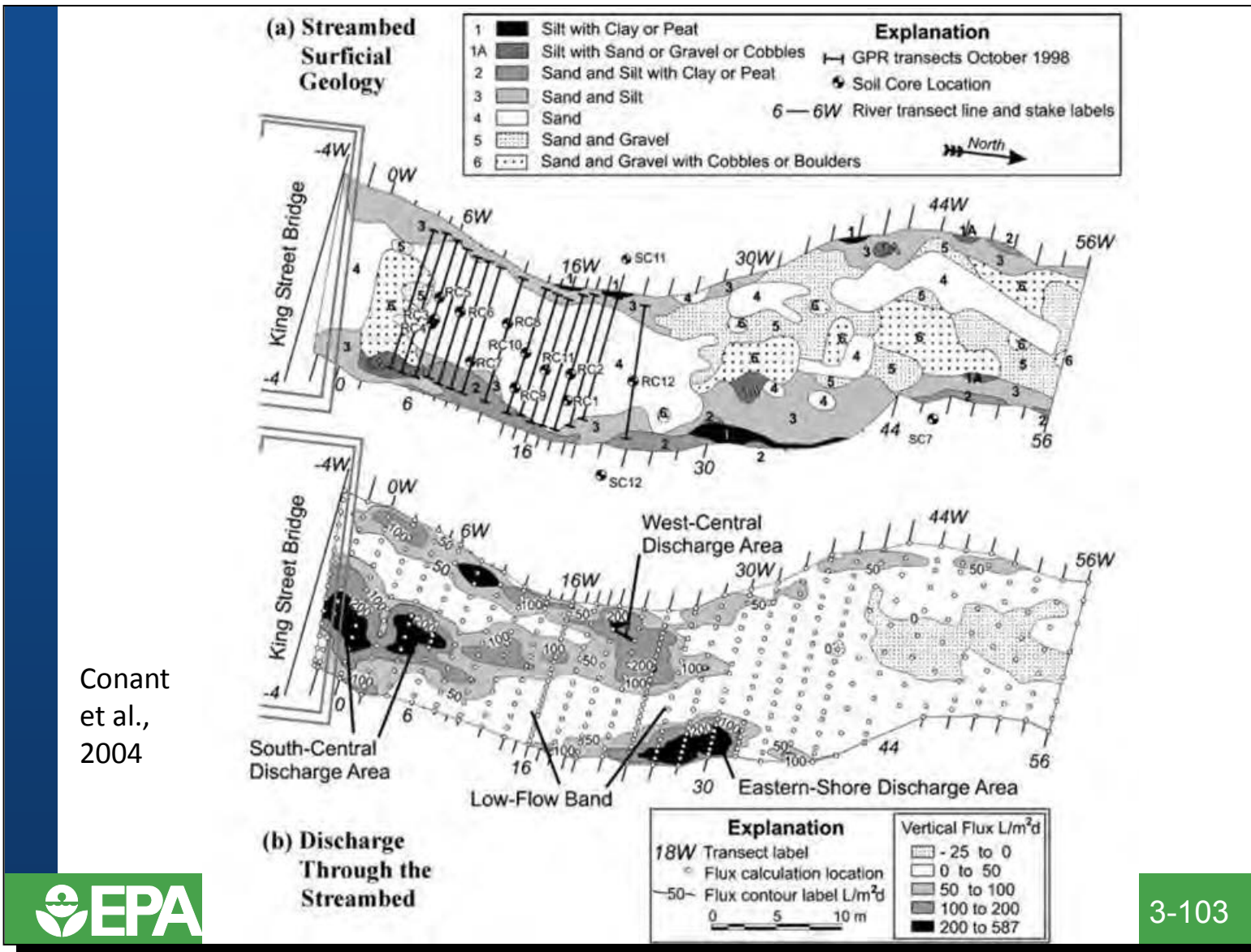

Notes

- ◆ The upper image shows a map of the distribution of the geologic materials making up the streambed, ranging from silt with clay or peat up to sand and gravel with cobbles or boulders. The distribution of geologic materials is very heterogeneous over short distance intervals. The lower diagram shows the vertical volumetric flux of groundwater mapped from many piezometer locations. The flux varies substantially from 0 to over 500 liters per square meter per day. There was even a zone of the streambed along this reach where the stream lost water to the aquifer. The zones of high flux are quite discrete and scattered around the streambed.

Distribution of Streambed Temperature

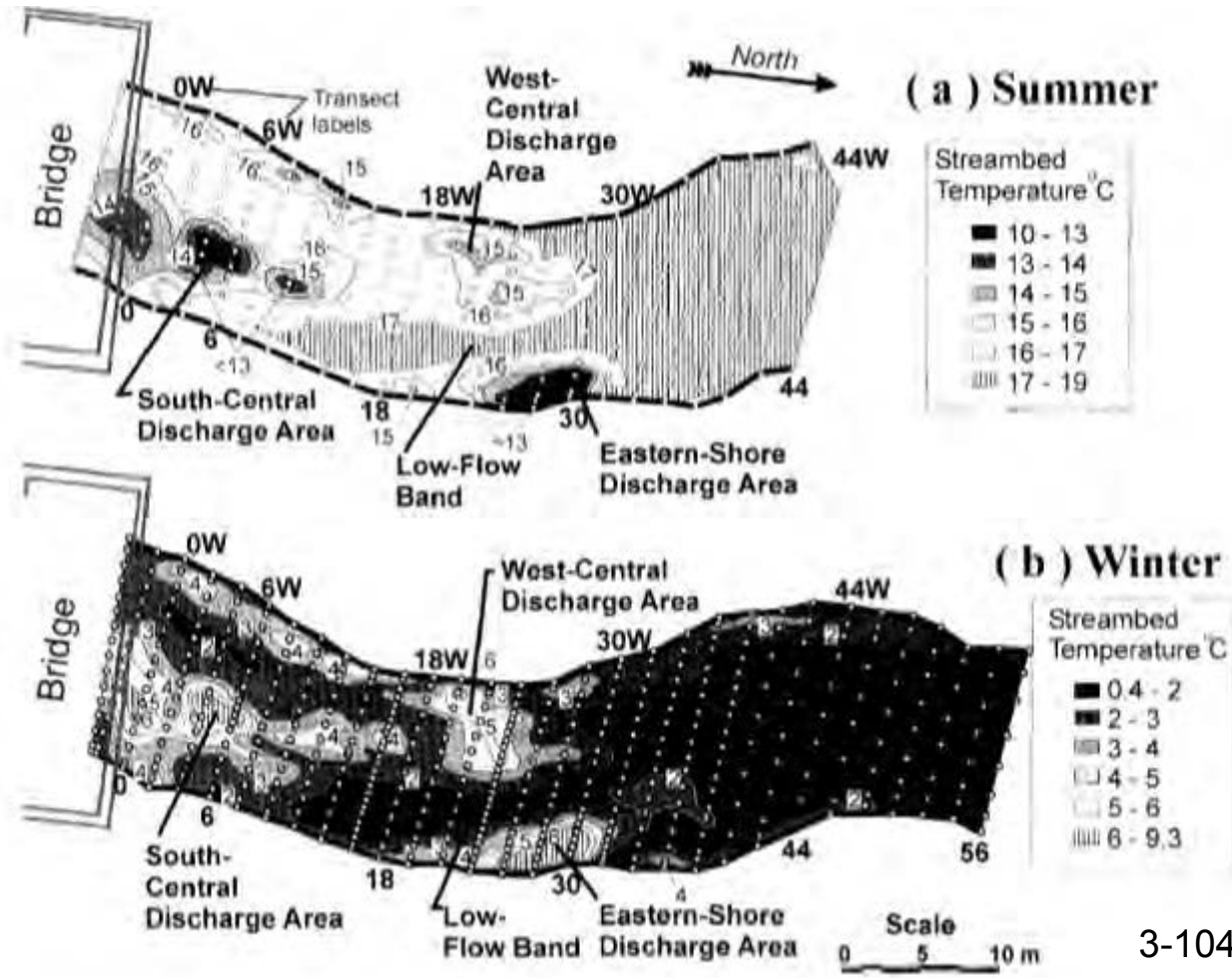

B. Conant Jr.
GROUND WATER 42,
no. 2: 243-257



3-104

Notes



- ◆ The upper diagram shows the distribution of the streambed temperature in the summer while the lower diagram shows the temperature distribution in the winter at the same monitoring locations. The absolute temperatures vary by approximately 10 degrees C, but the locations of the discharge zones as indicated by temperature are in the same places. Note that in the summer the groundwater discharge is cooler than the surface water while in the winter the groundwater discharge is warmer than the surface water.



Delineating and Quantifying Ground Water Discharge Zones Using Streambed Temperatures

by Brewster Conant Jr.¹

Abstract

Streambed temperature mapping, hydraulic testing using minipiezometers, and geochemical analyses of interstitial water of the streambed were used to delineate the pattern of ground water discharge in a sandy streambed and to develop a flux-based conceptual model for ground water/surface water interactions. A new and simple empirical method was used to relate fluxes obtained from minipiezometer data to streambed temperatures. The relationship allowed flux to be calculated at locations where only streambed temperature measurements were made. Slug testing and potentiometer measurements at 34 piezometers indicated ground water discharge ranged from 0.03 to 446 L/m²/day (and possibly as high as 7060 L/m²/day) along a 60 m long by 11 to 14 m wide reach of river. Complex but similar plan-view patterns of flux were calculated for both summer and winter using hundreds of streambed temperatures measured on a 1 by 2 m grid. The reach was dominated by ground water discharge and 5% to 7% of the area accounted for ~20% to 24% of the total discharge, < 12% of the total area consisted of recharge zones or no-discharge zones. A conceptual model for ground water/surface water interactions consisting of five different behaviors was developed based on the magnitude and direction of flux across the surface of the streambed. The behaviors include short-circuit discharge (e.g., high-flow springs), high discharge (e.g., preferential flowpaths), low to moderate discharge, no discharge (e.g., horizontal hyporheic or ground water flow), and recharge. Geological variations at depth played a key role in determining which type of flow behavior occurred in the streambed.

B. Conant Jr. GROUND WATER 42, no. 2: 243-257

Notes



- ◆ This paper by Brewster Conant focused on the use of temperature to detect and quantify zones of groundwater discharge to surface water.

Depth of Measurement in Streambed

- ◆ Temperature measuring points close to the streambed are more affected by air temp variation
- ◆ Deeper locations are groundwater temperatures and show little variation with air temp

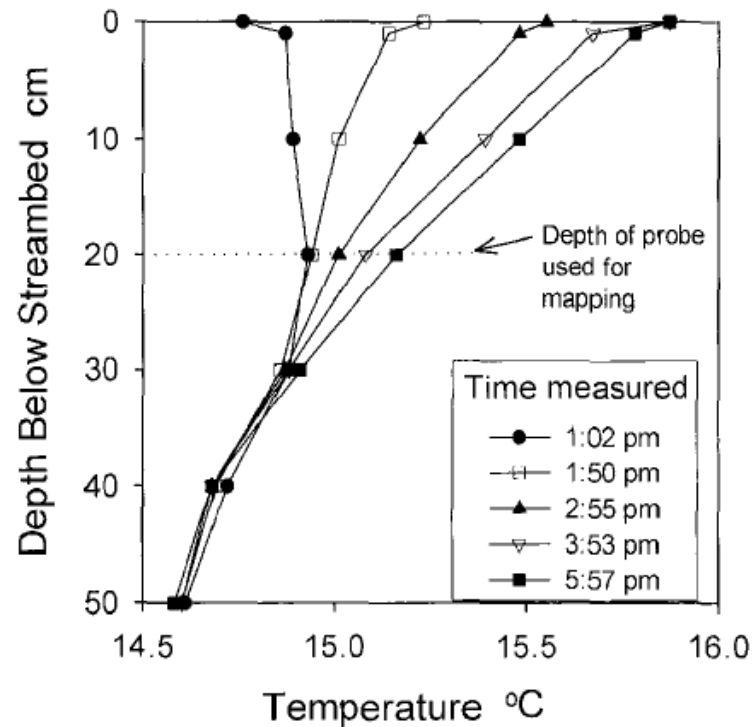

B. Conant Jr. GROUND WATER 42, no. 2: 243-257

Notes



- ◆ This diagram shows a temperature profile of the streambed at 5 different times throughout an afternoon in the summertime. The streambed temperature (0 cm) shows the greatest variation with time (air temperature) while temperatures 30 cm or more below the streambed are essentially groundwater temperatures and do not show much influence by changes in air temperature.

Using Temperature to Estimate Flux

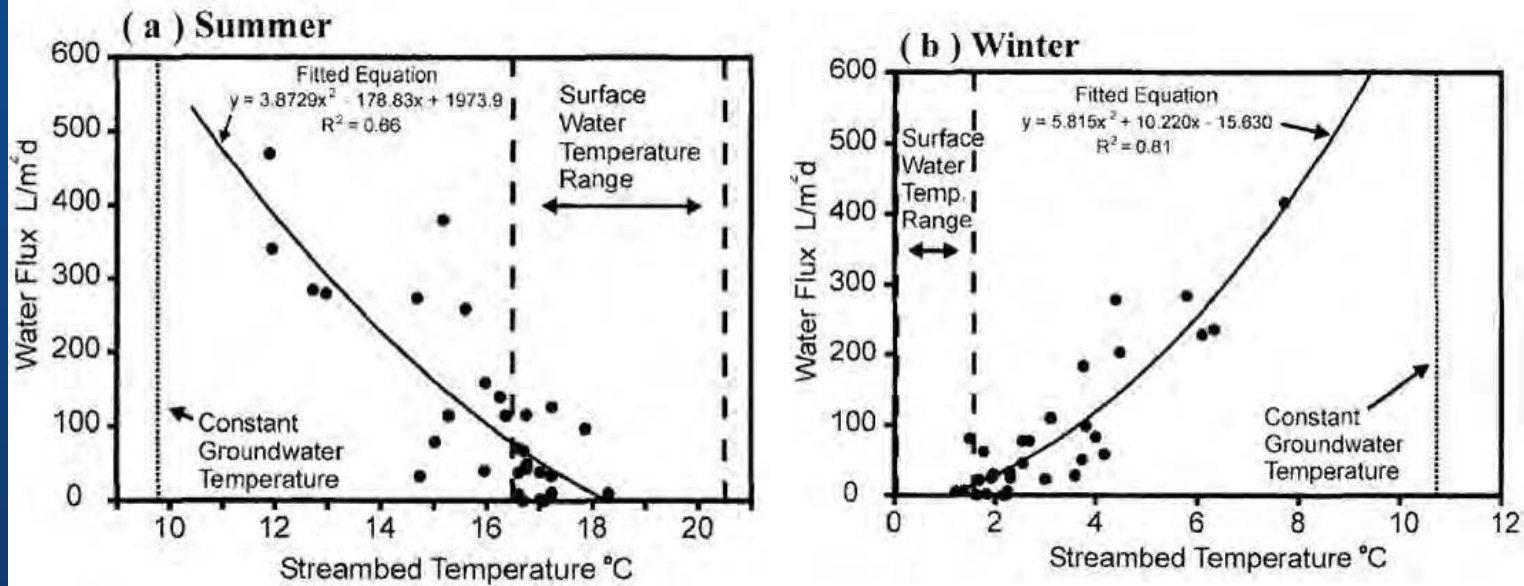

B. Conant Jr. GROUND WATER 42, no. 2: 243-257

Notes



- ◆ Conant et al., calculated volumetric groundwater flux distribution using Darcy calculations and then correlated those fluxes with temperature. The results are shown on the left for summer conditions and on the right for winter conditions. The polynomial fit is reasonably good indicating that once a stream is characterized, volumetric groundwater flux can be estimated using temperature data.

Key Findings

- ◆ “the near-river zone strongly modified the distribution, concentration, and composition of the plume prior to discharging into the surface water.”
- ◆ “Spatial and temporal variations in the plume entering the near-river zone contributed to the complex contaminant distribution observed in the streambed where concentrations varied by factors of 100 to 5,000 over lateral distances of less than 1 to 3.5 m.”
- ◆ “...geological heterogeneities at depth below the streambed controlled the pattern of groundwater discharge through the streambed and influenced where the plume discharged into the river (even causing the plume to spread out over the full width of the streambed at some locations).”
- ◆ “...essentially no biodegradation of the PCE plume was observed in the upgradient aquifer. Approximately 54% of the area of the plume in the streambed consisted solely of PCE transformation products, primarily cis-1,2-dichloroethene (cDCE) and vinyl chloride (VC).”

*Brewster Conant Jr. *, John A. Cherry, Robert W. Gillham
Journal of Contaminant Hydrology 73 (2004) 249-279*

Thermal Imaging

- ◆ IR Camera detects variations in temperature at a moment in time



Notes

- ◆ A rapid way to find temperature anomalies in surface water bodies that may indicate groundwater discharge are thermal imaging methods such as this infrared camera that the USGS uses. The technique is best used when there is a strong contrast between groundwater temperatures and surface water temperatures. Shallow groundwater temperatures are typically quite close to the mean annual air temperature. Therefore the best times to assess discharge are when the air temperatures are not near the mean, such as in summer and winter. In winter the groundwater discharge will typically be warmer than the surface water while in the summer the groundwater will be cooler. The thermal imaging methods measure the streambed temperature which as we saw in an earlier slide varies considerably with air temperature. Thus if creating images all day long, care must be used in comparing them as the streambed temperature likely changes throughout the day.

Forward Looking Infrared (FLIR)



(OU3)
Seep Detection, March 13, 2013

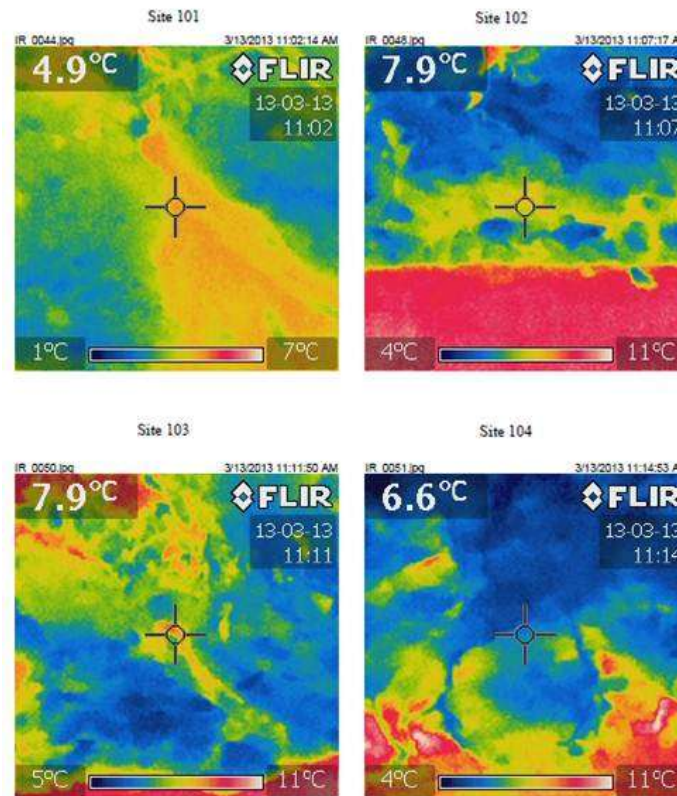

Notes

- ◆ Well known and understood technology originally developed for military and security applications. Used to detect thermal radiation (in the form of heat) to identify potential targets etc. in low light environments.
- ◆ In environmental application we can take advantage of these properties and commercially/widely available tools to use infrared to detect temperature differences. In this manner it is well suited for identifying seeps and other areas where temperature contrasts are indicative of surface water and groundwater mixing.
- ◆ The map photo was taken from EPA.gov and indicates average temperatures of shallow groundwater in the United States. Typical shallow GW temperatures can vary from the low 40s°F to mid-70s°F and are between 50-65°F for much of the U.S.
- ◆ Optimal times to conduct these surveys are in low light conditions where contrasts between groundwater and surface water are greatest. In the winter months when surface water temperatures are expected to be much lower than groundwater or in the summer months when surface water temperatures are expected to be much higher than groundwater.
- ◆ Pictures include average shallow groundwater temperatures taken from EPA.gov, a commercially available FLIR camera, and actual FLIR pictures from a USGS seep detection effort at a landfill site in EPA Region 3.

NOTE: This slide can be viewed in color in the Appendix A to this manual.

Specific Conductance Survey – Surface Water and Sediment

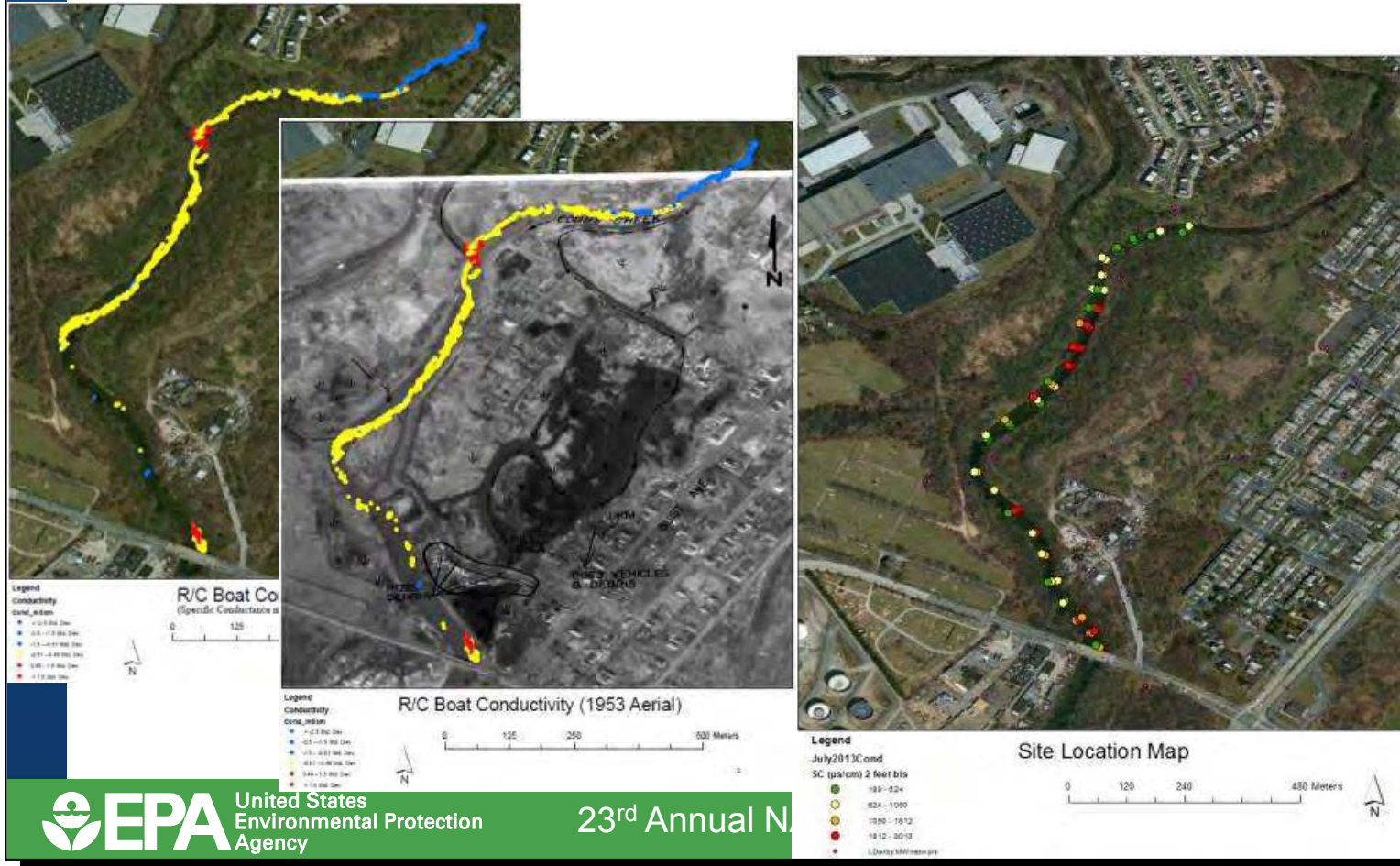

Notes

- ◆ In addition to gaining/losing stream assessments, water quality parameters like dissolved oxygen, oxidation reduction potential (ORP), temperature and FLIR applications, specific conductance is another measurement that can help identify areas of groundwater/surface water interaction at some sites.
- ◆ In the examples shown here from a landfill site in EPA Region 3, USGS used a commercially available conductivity probe mounted on a remote controlled boat to take a series of surface water specific conductance measurements before and after storm events. Data indicated that specific conductance can be used as a proxy for identifying areas where landfill leachate may be reaching surface water. Large variations (> 2 standard deviations) between baseline and storm measurements were potentially indicative of areas where leachate is entering a surface water body as the result of storm flow.
- ◆ For this project USGS also develop a special 6' specific conductance probe (not commercially available at this time) that could be pushed into sediments to identify changes in conductivity at varying depth intervals in stream sediments.

NOTE: This slide can be viewed in color in the Appendix A to this manual.

Distributed Temperature Sensor

- ◆ Distributed Temperature Sensing Systems (DTS) measure temperatures using fiber optics as linear sensors
- ◆ Temperatures are recorded along the optical sensor cable, in continuous profile
- ◆ High accuracy of temperature measurement is achieved over great distances
- ◆ Continuous measurement over kilometers
- ◆ 30 kilometers for each channel (some systems)
- ◆ Spatial resolution of about 1 meter (depends on configuration)
- ◆ Thermal resolution of about 0.01 degree Celsius (depends on configuration)
- ◆ Temporal resolution of seconds to hours depending on the desired thermal precision

Notes



- ◆ Distributed Temperature Sensors are a relatively new approach to temperature measurement/monitoring. DTS uses runs of fiber optic cable laid on the stream/pond bed. Pulses of laser light are sent down the cable and the return signal provides data from which the temperature along the cable can be calculated. This provides a continuous profile of the temperature rather than data at a few specific points. The data are quite accurate and high resolution.

DTS Deployment



<http://water.usgs.gov/ogw/bgas/fiber-optics/>

Notes



- ◆ The image on the left shows USGS personnel layout the fiber optic lines prior to deployment. The photo on the right shows the lines laid out parallel to each other and the shore line along multiple transects in shallow water.

Temperature Profile Along Stream Reach

Streambed Temperature
Stream Temperature = 17.6 deg C

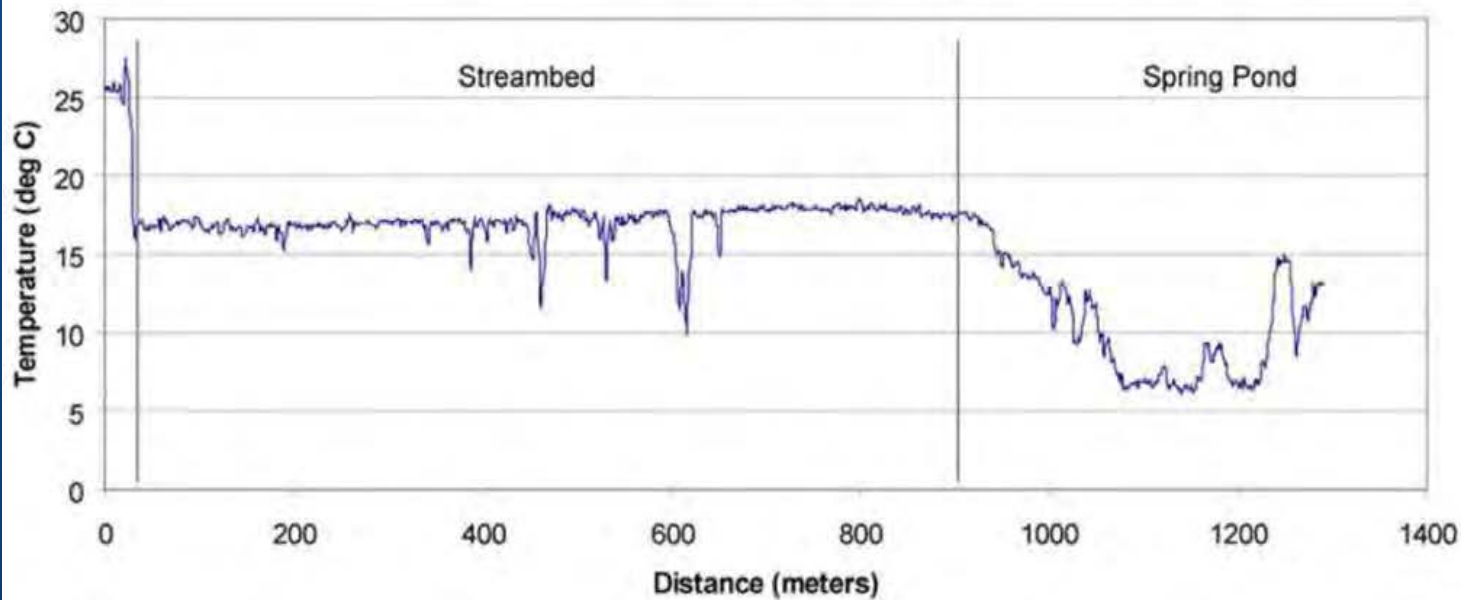

Identifying spatial variability of groundwater discharge in a wetland stream using a distributed temperature sensor. Christopher S. Lowry, John F. Walker, Randall J. Hunt, and Mary P. Anderson. WATER RESOURCES RESEARCH, VOL. 43. 2007

Notes



- ◆ In this diagram, a temperature profiler approximately 1,300 meters long is shown. Large variations are shown between 400 and 600 meters indicate strong groundwater discharge into the surface water. The portion of the diagram to the right of 900 meters shows a different behavior indicating a spring fed pond.

Questions?



Module 4 – HRSC Planning



HRSC Planning and Implementation

 **EPA** United States Environmental Protection Agency

23rd Annual NARPM Training Program

Module Overview

- ◆ Maximizing the use of existing data
- ◆ Obtaining collaborative data through HRSC
- ◆ HRSC planning checklist

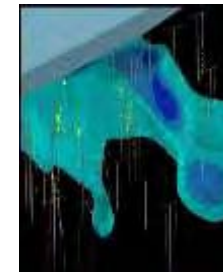

Maximizing the Use of Data

- ◆ Plan for effective use of data in dynamic work strategy
 - Identify stakeholders and engage them
 - Identify core technical team
 - Conduct systematic planning activities
- ◆ Compile and evaluate historical information
 - Basis for development of the preliminary CSM
- ◆ Identify data quality objectives including statistical evaluations
- ◆ Agree to project communications plan

Notes



- ◆ **Plan for effective use of data in dynamic work strategy:** HRSC is best implemented in a dynamic work strategy rather than a static sampling and analysis plan. Implementing an HRSC dynamic work strategy requires proper planning using several best management practices for conducting site characterization:
 - » **Identify stakeholders and engage them:** A stakeholder is any group or person with direct interest in the outcome of the project. Key stakeholders are those who can impose requirements or changes to a project, or whose work or interests are directly affected by information from the project. A key stakeholder usually has “veto” power over major project decisions and may be indispensable to the project because of his or her unique relationship and influence over key project decisions. The first step in developing a project organization is to identify all stakeholders and decision-makers. The level of interest in the site and its reuse plans will affect the number and type of stakeholders and decision-makers. It is important to be inclusive so that all concerns and opinions can be addressed in the CSM and DWS. Stakeholders and decision-makers may include federal and state agency personnel, local agency personnel, local elected officials, developers, community members, potentially responsible parties, environmental consultants, and key real-time technology providers and data end-users.
 - » **Identify core technical team:** The project manager is the leader of the core technical team and the point of contact for stakeholders and decision-makers. The rest of the core team members should have expertise in technical areas that will be necessary for the particular site. Most Triad investigations have core technical team members with expertise in geosciences, chemistry, biology, data management, quality assurance (QA), risk assessment, and engineering because these technical areas are involved in nearly every Triad project. A single person may address more than one area of expertise — for example, a chemist may also address QA. It is important to recognize that not all QA is confined to chemistry-related issues, so individuals with expertise in unique aspects of the project, such as specialty technology providers, need to be engaged in the project at an appropriate level of participation.
 - » **Conduct systematic planning activities:** The core technical team conducts site and technology research before the systematic planning meeting. The team then summarizes that information into a preliminary CSM and submits it to the stakeholders for review before the meeting. These actions increase the effectiveness of stakeholder discussions and improve their ability to reach consensus on a baseline CSM, as well as agree to the primary technologies to be used to execute the DWS.

- ◆ **Compile and evaluate historical information:** The core technical team conducts the following activities well ahead of the systematic planning meetings with the stakeholders: (1) evaluate existing data and summarize and depict current understanding using 3-D visualization if warranted, (2) identify obvious critical data gaps, (3) identify pathway-receptor networks, (4) consider possible reuse options, potential remedies and exit strategies, (5) summarize known project goals, including action levels or decision criteria, (6) identify known and potentially applicable real-time technologies, (7) identify technologies and methods that may require demonstrations of method applicability (DMA), and (8) outline probable data management, visualization, and communication strategy.
- ◆ **Identify data quality objectives including statistical evaluations:** HRSC data sets help to control error sources associated with sampling and measurement. Increased sampling density obtained with field-based technologies controls errors associated with sampling while strategic use of laboratory analysis in collaboration with field-based technologies controls measurement errors. To the extent it is possible, statistical evaluations of existing data can be made to help determine data gaps and to guide the HRSC data collection effort.
- ◆ **Agree to project communications plan:** HRSC has many moving parts and can involve a fairly large project team. The communications plan must address all portions of the project team. Below is a typical HRSC project organization for which a communication plan must be established.

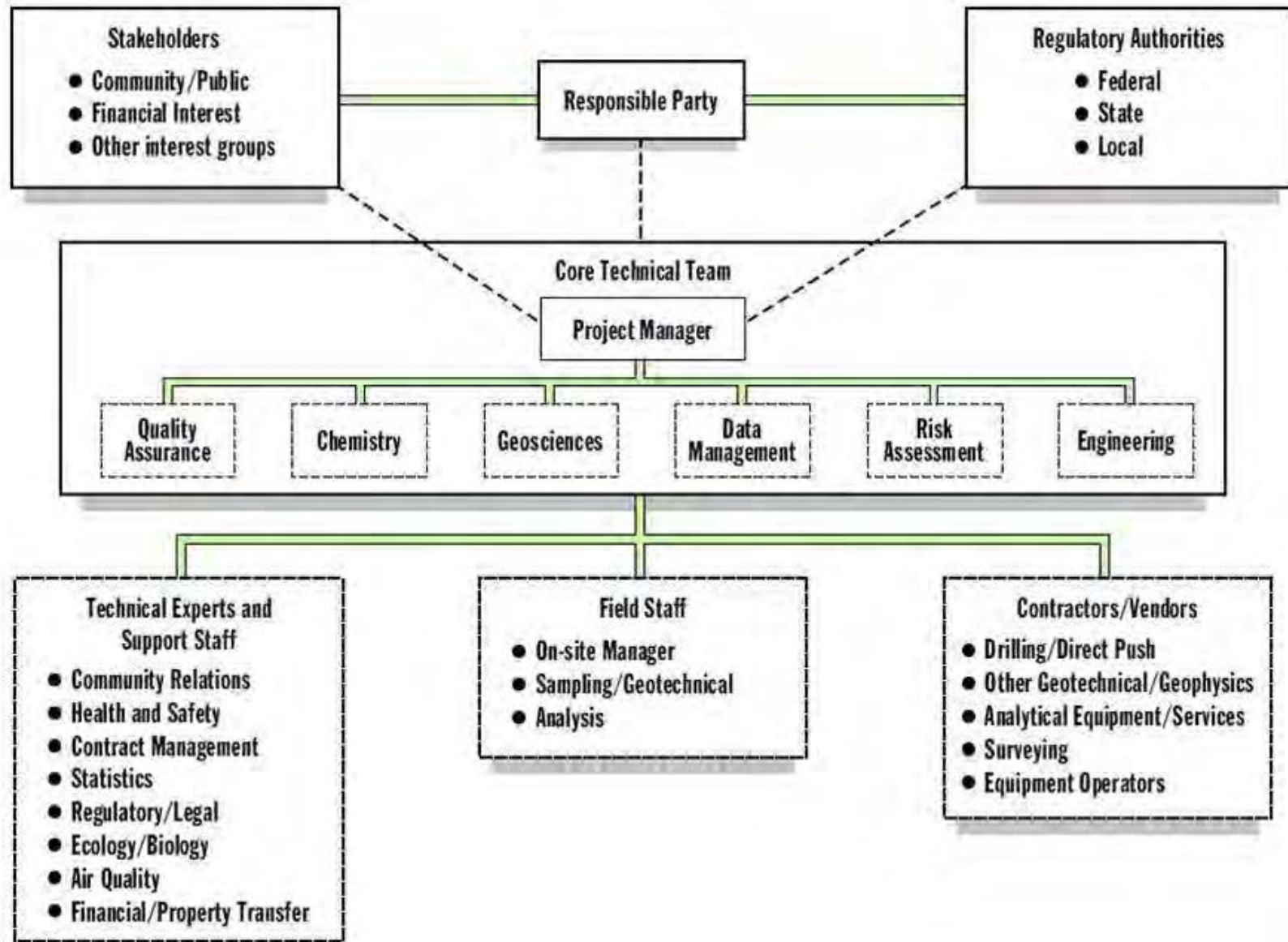

Collaborative Data

- ◆ Different methods for same analyte or suite of analytes
- ◆ Multiple lines of evidence = “weight of evidence”
 - Control project and site decision uncertainties
 - Revises decision criteria in response to data
- ◆ One method indicates when another is required or beneficial
- ◆ Control multiple error sources
 - Sampling design, matrix, prep, analytical
- ◆ Result: increased confidence in the CSM; better decisions, better remedy implementation
 - Characterization of chemistry and physical attributes with adequate data density

Notes



- ◆ **Different methods for same analyte or suite of analytes:** Collaborative data sets leverage the power of high-density real-time information of field technologies and the targeted high-precision and well-documented laboratory data. “Collaborative data sets” or “collaborative methods” refer specifically to the strategy of using two (or more) analytical methods to measure the “same” analyte or a surrogate of an analyte. For example, total uranium can be measured by XRF, gamma spectroscopy, and alpha spectroscopy. Polychlorinated biphenyls (PCBs) can be measured by IA and spectrophotometer, bioassays, GC/ECD, and high-resolution gas chromatography (HRGC)/MS. Collaborative methods are paired so that the strengths of one method can compensate for the limitations of the other. Frequently, a field method is selected for its ability to provide a much higher density of data points to manage the CSM and control small-scale variability or heterogeneity. The laboratory method, however, will generally achieve better detection limits, analyte specificity, and accuracy than the field method. (Note - field methods should not be confused with on-site analysis in an accredited mobile laboratory.) A DMA should be designed to guide the “marriage” of the techniques to produce reliable information that is not biased by the effects of heterogeneity or analytical inaccuracy.
- ◆ **Multiple lines of evidence = “weight of evidence”:** Terms such as “weight of evidence” or “multiple lines of evidence” and “collaborative data sets” have been developed to describe layered data sets. From a Triad perspective, there is a distinction between the two. “Weight (or lines) of evidence” refers to combining information from various different sources into a holistic picture (a CSM). For example, historical information may be used in conjunction with geological, hydrogeological, chemical, and geophysical data to predict contaminant fate and transport.
- ◆ **One method indicates when another is required or beneficial:** Through the use of field-based action levels for collaborative data sets, the data generated by the field method can provide information regarding which samples require off-site analysis or would be beneficial as a split sample to refine the relationship between the field-based and laboratory methods.
- ◆ **Control multiple error sources:** Collaborative data sets help to control error sources associated with sampling and measurement. Increased sampling density obtained with field-based technologies controls errors associated with sampling while strategic use of laboratory analysis in collaboration with field-based technologies controls measurement errors.
- ◆ **Result: increased confidence in the CSM, better decisions, better remedy implementation:** Collaborative data sets result in more accurate and complete CSMs. The decisions made based on the more complete CSMs have more certainty because they are based on a more accurate understanding of site conditions.

Why 3-D, Why Now?

- ◆ Beneficial for developing a more realistic CSM
- ◆ Matches well with dense data sets from HRSC
- ◆ Improves communication and outreach
- ◆ Integrates multiple data types into unified representations
 - 2-D visualizations have limited capability to integrate chemical, geologic and hydrogeologic information
- ◆ Aligns with EPA's National Optimization Strategy and Community Engagement Initiative
 - Renewed emphasis on high quality characterization in support of remedy selection, design and optimization
 - New focus on more meaningful and effective community engagement

Notes



- ◆ **Beneficial for developing a more realistic CSM:** By definition, the CSM is 3-D in nature. Therefore, to effectively understand the CSM and its associated data, it should ideally be viewed three dimensionally.
- ◆ **Matches well with dense data sets from HRSC:** During HRSC, a large volume of data is generated over a relatively short period of time. Because results are used on a real-time basis to optimize subsequent activities, data of all types need to be processed and presented quickly for evaluation.
- ◆ **Improves communication and outreach regarding site conditions:** 3-D visualizations are a powerful communication and outreach tool because they depict site conditions in a much more understandable way than tradition plan view maps or cross-sections.
- ◆ **Integrates multiple data types into unified representations:** Viewing the site and various data sets three dimensionally allows all stakeholders and project staff, regardless of technical background, to obtain a complete understanding of the site, proposed investigations, and results. Placing field data within the 3-D framework as a dynamic investigation allows for rapid assimilation of changes and needed adjustments. Although this is not a required component of building the database and outputting the displays for the site, the 3-D visualization concept is presented as an optional recommendation. When incorporating estimate distributions, volume, mass, and behavior over time in high resolution, the visualization becomes 4-dimensional (4-D).

In the past, these visualizations were expensive, time-consuming, and required extensive training to implement. Now, these services are available at a fraction of the cost and operate in a relatively short timeframe commensurate with a DWS. In addition, some of these services can be procured to download visualizations to free media players so that all stakeholders can easily view and understand with no cost for software purchase and no software training.

- ◆ **Aligns with the EPA's National Optimization Strategy and Community Engagement Initiative:** HRSC and 3-D visualization will assist the EPA in implementing its National Optimization Strategy for Superfund, which renews the EPA's emphasis on high quality characterization in support of remedy selection, design, implementation and optimization. In addition, the power of 3-D visualization as a communication tool will help the EPA to engage the communities affected by contaminated sites in a more meaningful way.

Data Interpretation

- ◆ Separating data from interpretation
 - Data should lead the approach
 - Identify variables
 - Evaluate relationships of variables
 - Identify key drivers
 - Strive for spatially correct correlations
 - Expand DQOs from focus on analytical quality to consider uncertainty of spatial and temporal variations
- ◆ Addressing “outliers”
 - Outliers provide insights into sampling procedures and CSM
 - Few cases where throwing out data makes sense
 - Justification needs more basis than “because its an outlier”

Data Visualization Tools

- ◆ Tools are available for visualizing and evaluating subsurface data in 2-D and 3-D

Typical 2-D map of plume based on 7 wells

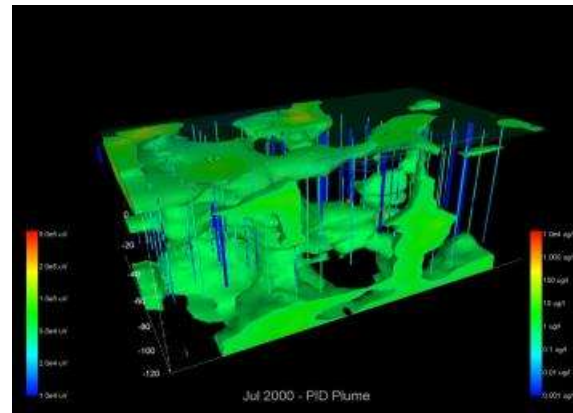
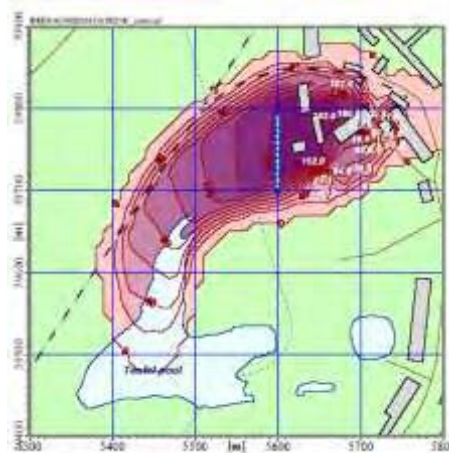

3-D plume visualization based on over 50 sampling locations

- ◆ Estimate distributions, volume, mass, and behavior over time in high resolution (4-D)

HRSC Planning Checklist

◆ Addresses

- Hydrostratigraphy
- Flow System
- Mass Flux at Distal Portion of Plume
- Plume Fringe or Terminus
- Location of Plume Core
- Source Zone Definition

◆ Checklist is part of PDF manual

Groundwater High-Resolution Site Characterization Checklist

1) **Hydrostratigraphic data available?** Such as stratigraphy, grain size distribution, permeability (hydraulic conductivity), porosity, etc. Are these data distributed in 3 dimensions and has their variability been assessed?

- Yes:** Fill data gaps with other tools but ground truth against existing core logs.
- No:** Perform full-depth continuous soil cores and borings.

Applicable tools: Direct push soil coring tools (single rod, dual tube), rotary rig methods (split barrel sampling), sonic methods.

Other tools: HPT, Waterloo^{APS}, Electrical conductivity profiling, CPT, surface geophysics (wide variety depending on geology and information needed).

Strategy: Start at location with known geology to “ground truth” other methods.

2) **Flow system understood?**

- Yes:** Review flow system data needs and if still Yes, *Go to 3)*
- No:** *Continue.*

i) **Flow system is steady state or transient?**

This requires either existing time series hydraulic head data or suspicions of things like tidal influences, seasonal variability in recharge, etc.

- Steady State:** Permanent piezometers not necessary initially.
- Transient:** Install "permanent" piezometers early in the process. Understand what conditions are while you are investigating.

Applicable tools: Direct push piezometers, piezometers installed with drill rigs, pressure transducers, staff gauges, mini piezometers.

ii) **Dual porosity flow system (low K zones with high K matrix or vice versa)? A relatively small difference (such as, two orders of magnitude) in K values can create dual porosity systems.**

- Yes:** Groundwater sampling in high K zones and soil sampling in low K zones
- No:** Groundwater sampling only

iii) Significant vertical components of hydraulic gradient?

- Yes:** Make multiple water level measurements and install multi-level piezometers at various locations around the investigation area to understand contaminant transport.
- No:** Make head measurements at single elevation

iv) Flow system isotropic?

- Yes:** Re-evaluate as this is rarely the case.
- No:** Perform a detailed profiling-style investigation with transects.

***Note:** The plume itself is probably the best indicator of the anisotropy and it will be necessary to use it as a tracer. Understanding the hydraulic gradient in anisotropic systems will not be sufficient to figure out where the plume is headed (or where it came from).*

3) Plume fringes/terminus understood?

- Yes:** Track boundaries with temporal monitoring points.
- No:** Groundwater sampling required.

***Note:** MIP and LIF are not suitable tools for finding plume fringes due to lack of sensitivity to low concentrations.*

4) Mass flux at distal end understood?

- Yes:** *Go to 5)*
- No:** Complete transect across flux boundary.

***Note:** The information along this boundary needs to include concentration, hydraulic conductivity, and hydraulic gradient. In addition to normal sampling tools, passive flux meters can be used to determine flux across a plane.*

5) Plume core(s) located?

- Yes:** *Go to 6)*
- No:** Use screening tool such as MIP to find plume core; follow up with more definitive methods.

6) Source zone well defined?

- Yes:** Additional source sampling not needed.
- No:** *Continue.*

i) Overall source volume defined?

- Yes:** Use current volume estimates .
- No:** Evaluate zone using screening tool such as MIP or LIF; follow up with more definitive methods.

ii) NAPL likely in source zone?

- No:** *Go to iii)*
- Yes:** *Continue.*

(a) DNAPL found/delineated?

- Yes:** Transect sampling to address any data gaps.
Applicable tools: *FLUTe NAPL Ribbons; MIP; Coring; Vertical Groundwater Profiling; Dye LIF*
- No:** Primary concern will be dissolved concentrations.

(b) Source material in vadose zone, saturated zone, or both?

- Vadose zone only:** Grid sampling based on likely source locations.
Applicable tools: *Soil gas sampling; FLUTe NAPL Ribbons; MIP; LIF (aromatics only), Coring*
- Saturated zone only:** Transect sampling at right angle to direction of hydraulic gradient or longitudinal plume axis.
Applicable tools: *FLUTe NAPL Ribbons; MIP; LIF (aromatics only) Coring; Waterloo^{APS} or other vertical profiling*
Note: *Start with MIP or vertical profiling to provide a “window” into likely source positions. Then use direct methods like NAPL ribbons and soil coring (with hydrophobic dye, subcore sampling and phase portioning equations etc.) to determine actual DNAPL presence/absence.*
- Both vadose zone and saturated zone:** Combined grid and transect-based sampling (see vadose zone only and saturated zone only above).

iii) Mass distribution within source zone defined?

- Yes:** Evaluate confidence in definition.
- No:** *Continue.*

(a) Flow system is dual porosity system?

- Yes:** Sample both in permeable and low K zones.

Applicable tools: MIP; coring, vertical profiling (for example, Waterloo^{APS})

Note: Begin with a screening tool such as the MIP which can provide data in both high and low K zones. Then use definitive tools such as coring in low K zones and groundwater profiling in high K zones to determine mass distribution.

- No:** Sample pore fluids in permeable zone only.

(b) Mass flux out of source area understood?

- Yes:** *Finished!*
- No:** Conduct transect across flux boundary.

Note: The information along this boundary needs to include concentration, hydraulic conductivity, and hydraulic gradient. This can be accomplished with vertical profiling tools, slug testing, and water level measurements. In addition to normal sampling tools, the U of Florida Passive Flux Meters can be used to determine flux across a plane.

A note on proper horizontal and vertical sample spacings:

If possible use a continuous screening tool such the MIP to determine spatial variability, and then base your subsequent sampling depths on the MIP results. It is best to start with close horizontal spacings if the spatial structure of the plume is unknown. As you acquire data you can increase the spacings to match the degree of spatial variability in the plume.

Checklist – 1) Hydrostratigraphy

- ◆ **Hydrostratigraphic data availability**
 - Are there measurements of stratigraphy, grain size distribution, permeability (hydraulic conductivity), porosity, etc. Are these data distributed in 3 dimensions and has their variability been assessed?
- ◆ **Yes:** Fill data gaps with other tools but ground truth against existing core logs
- ◆ **No:** Perform full-depth continuous soil cores and borings

Hydrostratigraphy Tools

- ◆ **Applicable tools**: *Direct push soil coring tools (single rod, dual tube), rotary rig methods (split barrel sampling), sonic methods*
- ◆ **Other tools**: *HPT, Waterloo^{APS}, electrical conductivity profiling, CPT, surface geophysics (wide variety depending on geology and information needed)*

Hydrostratigraphy – Strategy

- ◆ **Strategy**: Start at location with known geology to “ground truth” other methods

Checklist – 2) Flow System

- ◆ **Flow system understanding**
 - **Steady state or transient?**
 - **Dual porosity system?**
 - **Significant vertical components of hydraulic gradient?**
 - **Is flow system isotropic horizontally?**
- ◆ **If Yes: *Go to 3) Plume fringe/terminus***
- ◆ **If No: *Continue.***

Flow System Steady State or Transient?

- ◆ This requires either existing time series hydraulic head data or suspicions of things like tidal influences or seasonal variability in recharge
 - **If Steady State:** Permanent piezometers not necessary initially
 - **If Transient:** Install "permanent" piezometers early in the process. Understand what conditions are while you are investigating

Flow System Tools

- ◆ **Applicable tools:** Direct push piezometers, piezometers installed with drill rigs, pressure transducers, staff gauges, mini piezometers

Flow System – Dual Porosity

- ◆ **Dual porosity flow system (low K zones with high K matrix or vice versa)**
 - Differences of two orders of magnitude in K can create dual porosity systems
- ◆ **Yes:** Groundwater sampling in high K zones and soil sampling in low K zones
- ◆ **No:** Groundwater sampling only

Flow System and Vertical Hydraulic Gradient

- ◆ **Significant vertical components of hydraulic gradient?**
 - **Yes:** Make multiple water level measurements and install multi-level piezometers at various locations around the investigation area to understand contaminant transport
 - **No:** Make head measurements at single elevation

Flow System and Isotropy

◆ Flow system isotropic?

- **Yes:** Re-evaluate as this is rarely the case
- **No:** Perform a detailed profiling-style investigation with transects

Note: *The plume itself is probably the best indicator of the anisotropy and it will be necessary to use it as a tracer. Understanding the hydraulic gradient in anisotropic systems will not be sufficient to figure out where the plume is headed (or where it came from).*

Checklist – 3) Plume Fringe or Terminus

- ◆ **Understanding of plume fringe or terminus**
 - **Are concentrations at the plume terminus correlated with depth and hydraulic conductivity?**
- ◆ **Yes:** Track boundaries with temporal monitoring points
- ◆ **No:** Groundwater sampling required

Note: MIP and LIF are not a suitable tools for finding plume fringes due to lack of sensitivity to low concentrations

Checklist – 4) Mass Flux at Distal Portion of Plume

- ◆ **Is the mass flux at the distal portion of the plume well understood?**
 - **Yes:** Go to 5) Location of Plume Core
 - **No:** Complete transect across flux boundary

Note: *The information along this boundary needs to include concentration, hydraulic conductivity and hydraulic gradient. In addition to normal sampling tools, passive flux meters can be used to determine flux across a plane*

Checklist – 5) Location of Plume Core

- ◆ **Is the plume core location adequately defined?**
 - **Yes:** *Go to 6) Source Zone Definition*
 - **No:** Use screening tool such as MIP to find plume core; follow up with more definitive methods

Checklist – 6) Source Zone Definition

◆ Is the source zone well defined?

- **Yes:** Additional source sampling not needed
- **No:** *Continue.*

Source Zone Definition – Volume and NAPL

- ◆ **Overall source volume defined?**
 - **Yes:** Use current volume estimates
 - **No:** Evaluate zone using screening tool such as MIP or LIF; follow up with more definitive methods
- ◆ **NAPL likely in source zone?**
 - **No:** *Go to 6(iii) Mass Distribution*
 - **Yes:** *Continue.*

Source Zone Definition – DNAPL

- ◆ **DNAPL found and delineated?**
- ◆ **Yes:** Transect sampling to address any data gaps
 - **Applicable tools:** *FLUTe NAPL Ribbons; MIP; Coring; Vertical Groundwater Profiling; Dye LIF*
- ◆ **No:** Primary concern will be dissolved concentrations

Source Zone Definition – Location

- ◆ **Source material in vadose zone, saturated zone, or both?**
 - **Vadose zone only:** Grid sampling based on likely source locations
 - **Applicable tools:** Soil gas sampling; FLUTE NAPL Ribbons; MIP; LIF (aromatics only); Coring
 - **Both vadose zone and saturated zone:** Combined grid and transect-based sampling (see vadose zone only and saturated zone only above)

Source Zone Definition – Location

◆ Source material in vadose zone, saturated zone, or both?

- **Saturated zone only:** Transect sampling at right angle to direction of hydraulic gradient or longitudinal plume axis
- **Applicable tools:** *FLUTe NAPL Ribbons; MIP; LIF (aromatics only); Coring; Waterloo^{APS} or other vertical profiling*

Note: *Start with MIP or vertical profiling to provide a “window” into likely source positions. Then use direct methods like NAPL ribbons and soil coring (with hydrophobic dye, subcore sampling and phase partitioning equations) to determine actual DNAPL presence or absence*

Source Zone Definition – Location

- ◆ **Source material in vadose zone, saturated zone or both?**
 - **Both vadose zone and saturated zone:** Combined grid and transect-based sampling (see vadose zone only and saturated zone only above)

Source Zone Definition – Mass Distribution

- ◆ **Mass distribution within source zone defined?**
 - **Yes:** Evaluate confidence in definition
 - **No:** *Continue.*

Source Zone Definition – Mass Distribution

◆ Flow system is dual porosity system?

- **Yes:** Sample both in permeable and low K zones
 - **Applicable tools:** MIP; coring, vertical profiling (for example, Waterloo^{APS})

Note: Begin with a screening tool such as the MIP which can provide data in both high and low K zones. Then use definitive tools such as coring in low K zones and groundwater profiling in high K zones to determine mass distribution.

- **No:** Sample pore fluids in permeable zone only

Source Zone Definition – Mass Flux from Source Area

◆ Mass flux out of source area understood?

- **Yes:** *Finished!*
- **No:** Conduct transect across flux boundary

Note: *The information along this boundary needs to include concentration, hydraulic conductivity and hydraulic gradient. This can be accomplished with vertical profiling tools, slug testing and water level measurements. In addition to normal sampling tools, the passive flux meters can be used to determine flux across a plane.*

Proper Sample Spacing

- ◆ **A note on proper horizontal and vertical sample spacings:**
 - *If possible use a continuous screening tool such the MIP to determine spatial variability*
 - *Base your subsequent sampling depths on the MIP results*
- ◆ *It is best to start with close horizontal spacings if the spatial structure of the plume is unknown. As you acquire data you can increase the spacings to match the degree of spatial variability in the plume.*

Questions?



Module 5 – Wrap Up

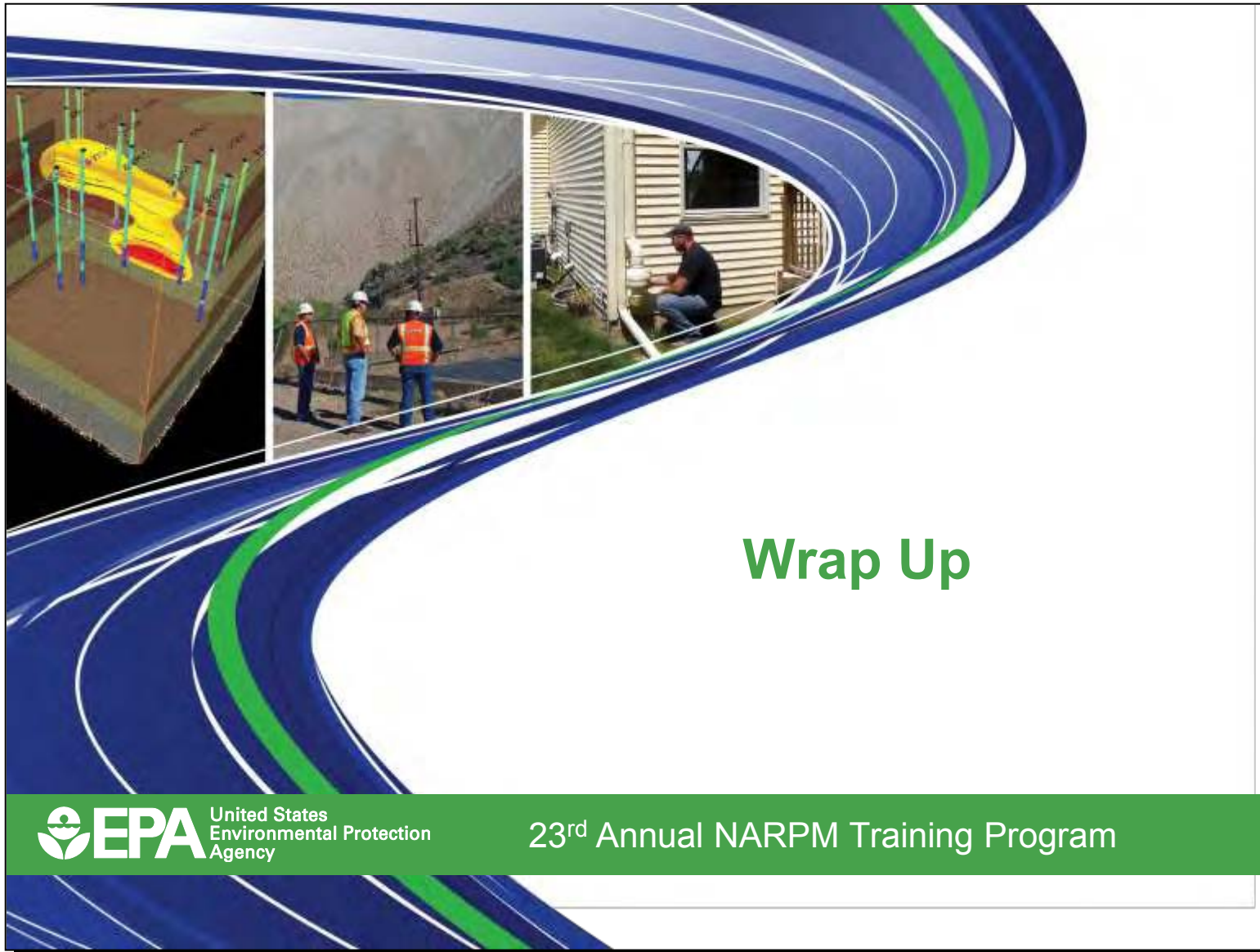

Wrap Up

 **EPA** United States Environmental Protection Agency

23rd Annual NARPM Training Program

Course Review

- ◆ HRSC uses transects of vertical profiles to overcome challenges of subsurface heterogeneity
 - Improved tools allow this approach for shallow and deep unconsolidated environments
 - Monitoring wells are not optimal characterization tools because they are making measurements at too large of a scale
- ◆ HRSC results provide the detailed information necessary to design and implement targeted in situ and ex situ remedies
 - HRSC can find the 75% to 95% of contaminant mass discharging in 5 to 25% of an unconsolidated aquifer, allowing the selected remedial action to target those zones

(continued)

Course Review

- ◆ The Triad Approach should be used to plan and implement HRSC
 - Systematic project planning
 - Dynamic work strategies
 - Real-time measurement technologies
- ◆ 3- and 4-D visualizations are useful for seeing existing data as well as newly generated HRSC data
- ◆ HRSC is applicable to the characterization of shallow and deep unconsolidated environments and fractured bedrock environments

Course Evaluations

PLEASE

Fill Out The Course Evaluation Form – Your Input is Valuable

And

Go Forth and Properly Characterize Groundwater!!!

Case Study

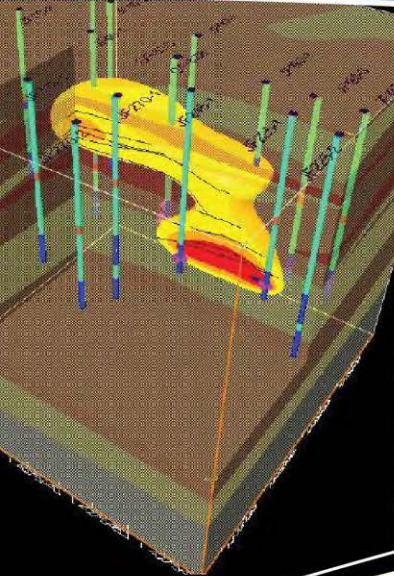

Lower Darby Creek Area Superfund Site

Clearview Landfill Groundwater Investigation

June 16, 2014

Josh Barber, RPM

Lower Darby Creek Area (LDCA) Superfund Site

- ◆ Clearview and Folcroft Landfills
- ◆ Philadelphia & Delaware County, PA
- ◆ Folcroft in John Heinz NWR
- ◆ Clearview LF 2 miles upstream of Folcroft LF
- ◆ NPL - 6/14/2001

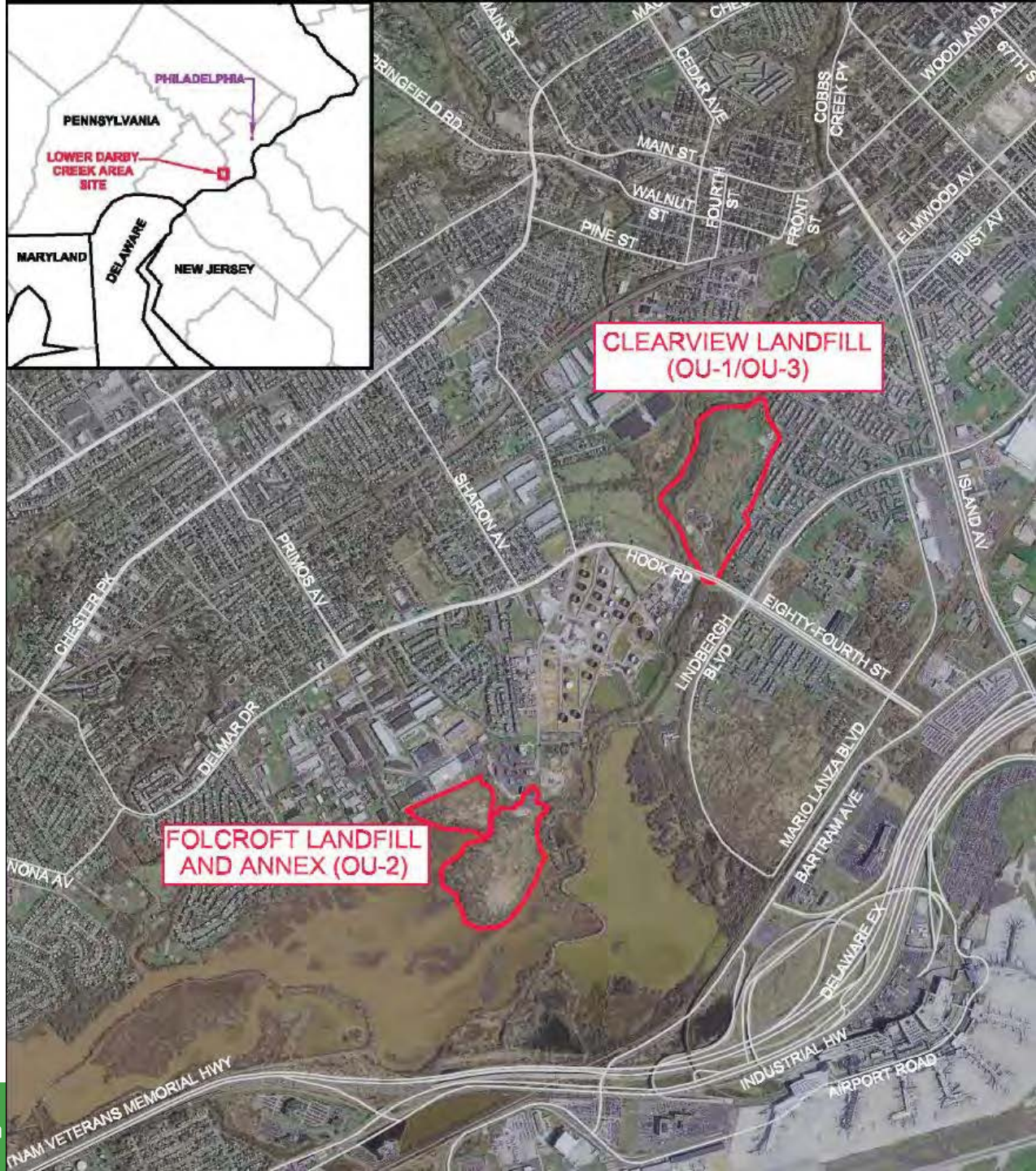

Clearview Landfill Historic Photos



Source: USEPA, 1984

Clearview Landfill (Fund Lead) Site Map & HHRA Soil Zones

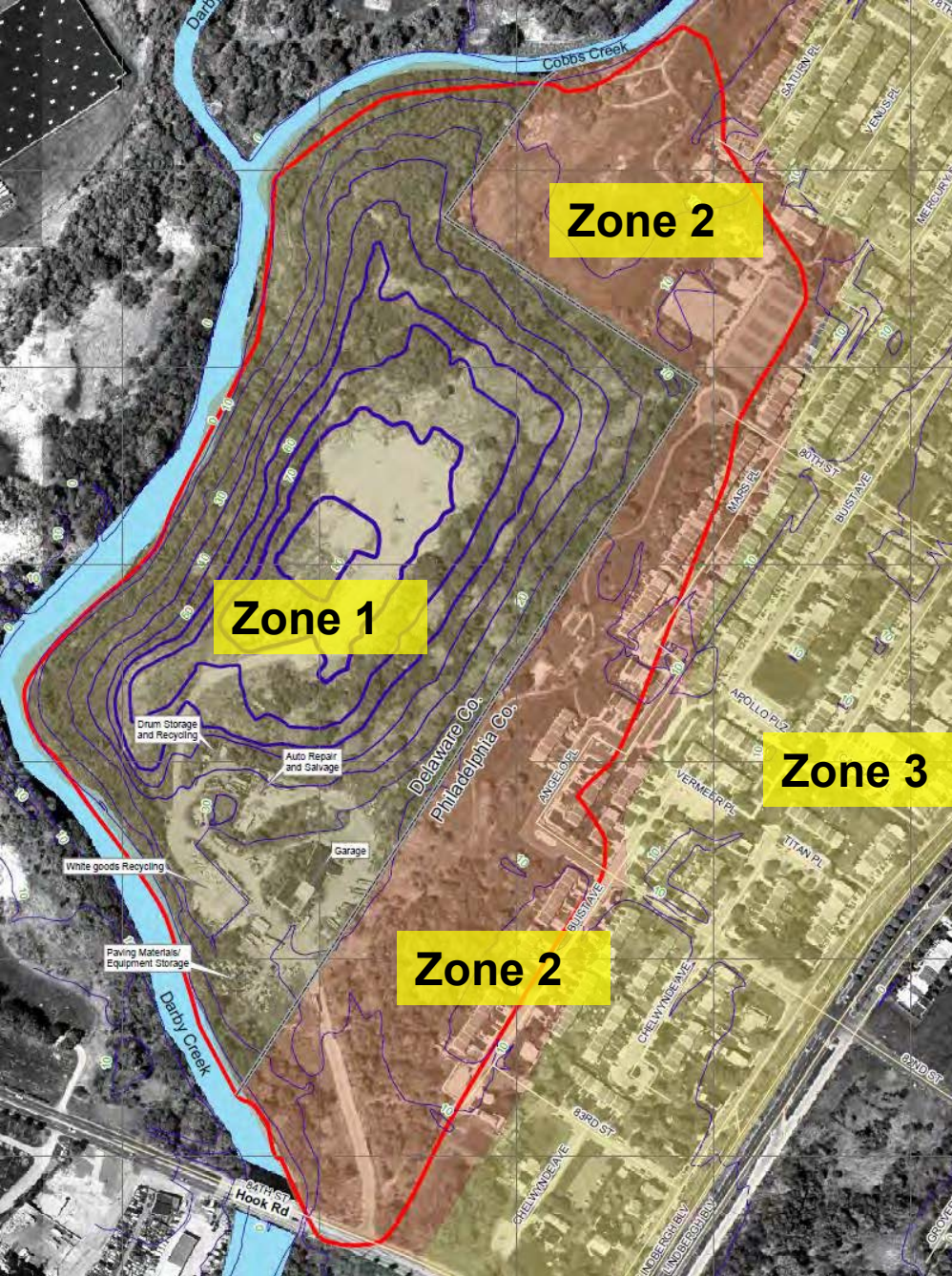

- ◆ Philadelphia (Eastwick) & Darby Township
- ◆ Former Open Dump
 - OU-1: Soils and Waste
 - OU-3: Clearview Groundwater (formed 2012)
- ◆ OU1 COCs
 - PAHs, PCBs, Cd, Cu, Pb, Zn
- ◆ OU1 Remedy
 - Evapotranspiration Cover (~50 acres)
 - Excavation & Consolidation
 - Leachate Collection Trench
 - Engineered Treatment Wetlands
 - ICs & LTM

Clearview Landfill OU-3 Groundwater Investigations



◆ 2002-2006 – MWs 1-12

- No bedrock

◆ 2011 – MWs 13-18

- Overburden/Bedrock pairs

← Estimated extent of landfill leachate based on specific conductivity (August 2011)

◆ Groundwater/Surface Water Interaction not well understood

- Leachate samples collected during RI

◆ 1,4-Dioxane at eastern edge of MW network

◆ TCE, daughter products, 1,4-D in MW-13 bedrock cluster

Shallow Aquifer Groundwater Contour Map (August 2011)



Deep Aquifer Groundwater Contour Map (August 2011)

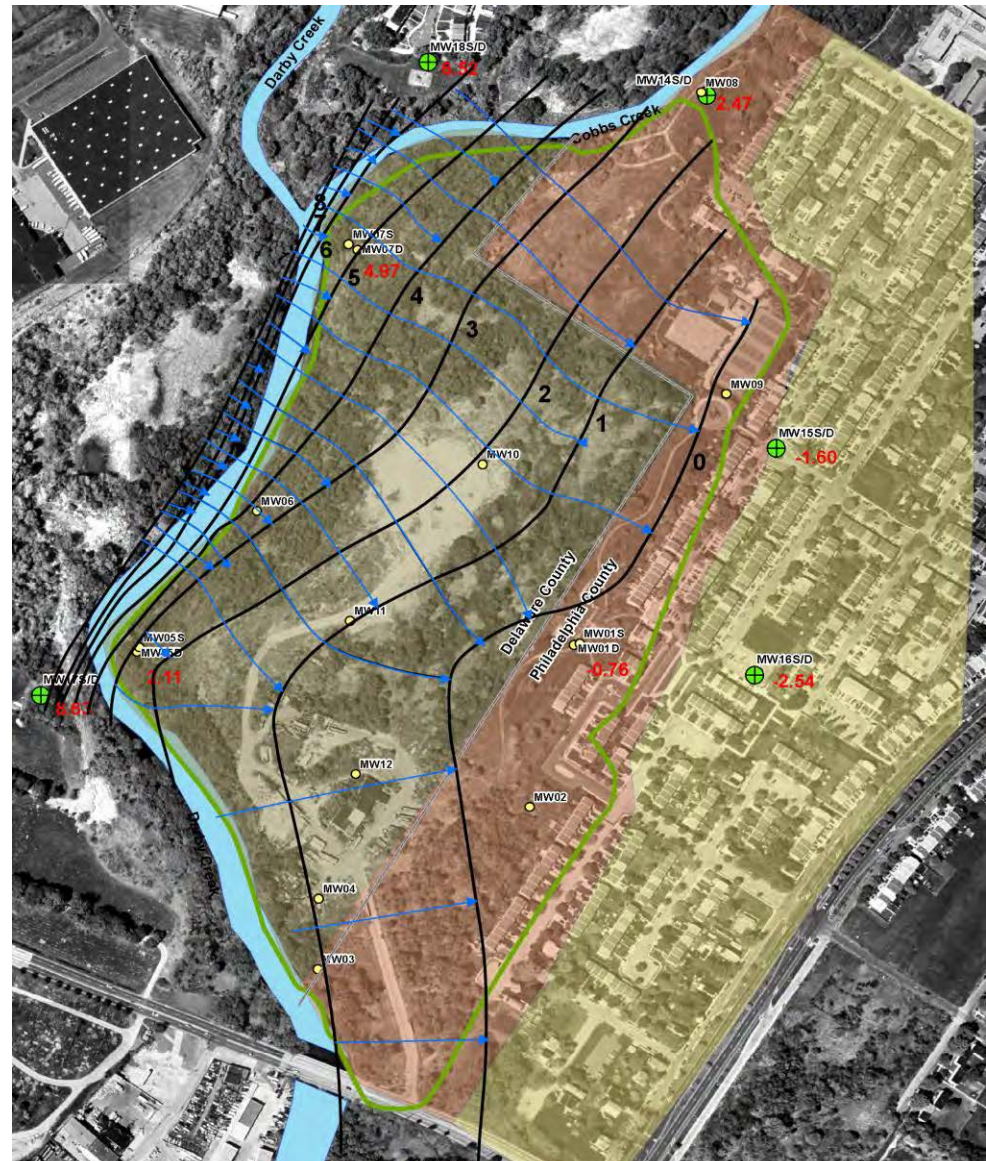

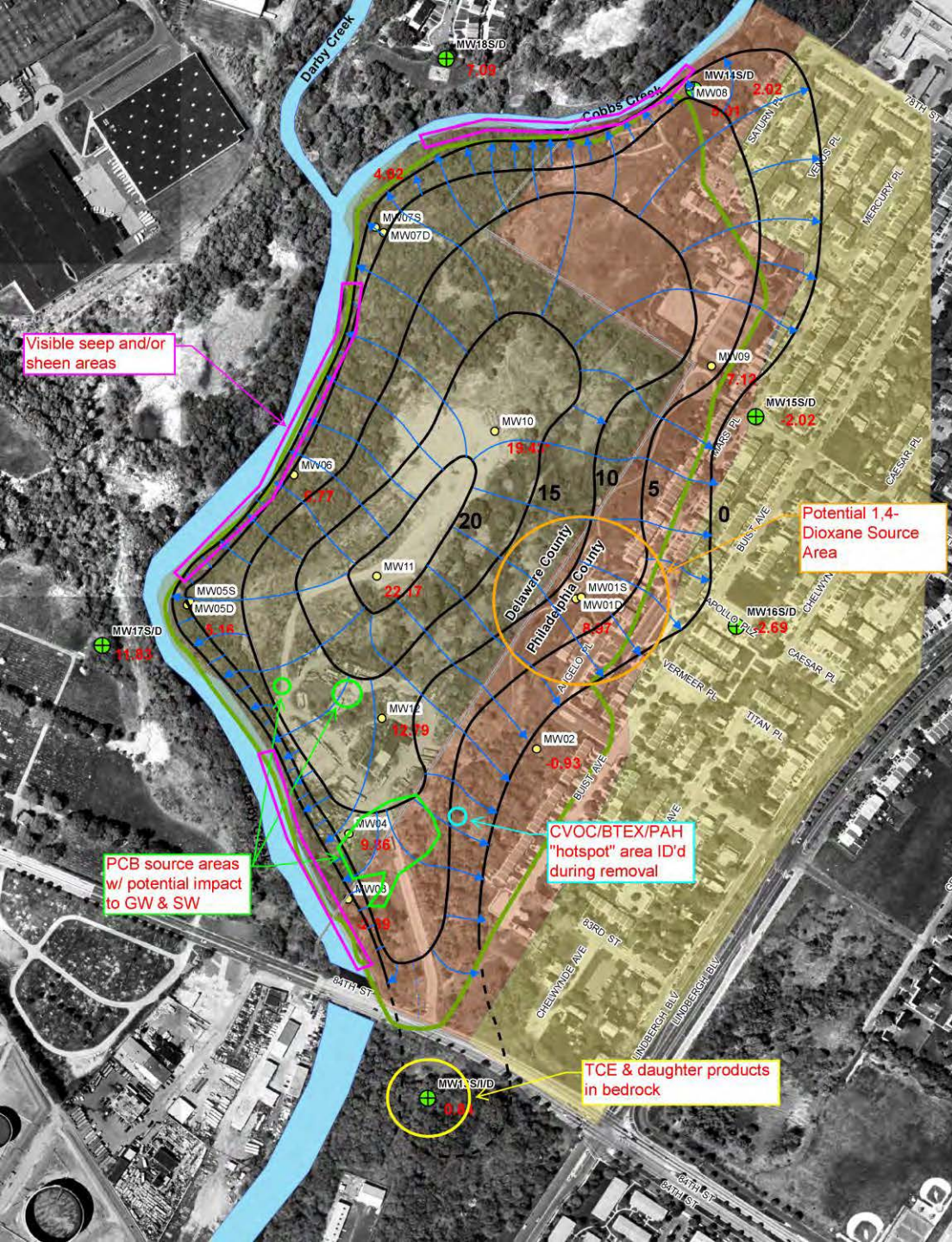

Areas of Interest for OU3 RI

OU-3 Project Objectives

- ◆ Determine the nature and extent of impacted groundwater migrating eastward outside the historic landfill boundary within the coastal plain aquifer and potentially the bedrock aquifer.
- ◆ Determine the nature of potentially impacted bedrock aquifer south of the landfill;
- ◆ Determine the movement of groundwater from Clearview Landfill into or beneath adjacent surface water bodies; and
- ◆ Determine interactions along the groundwater and surface water interface adjacent to the landfill.

Major Investigative Tasks

◆ Shallow Aquifer Assessment

- Coastal Plain sediments; 10'-50' thick in this area

◆ Deep Aquifer Assessment

- Wissahickon schist; highly weathered; fall line

◆ Pore Water Assessment

*** Support from EPA ERT and USGS

Initial List of Risk Drivers in Groundwater

- ◆ 1,4-Dioxane
- ◆ 1,4-Dichlorobenzene
- ◆ Naphthalene
- ◆ Bis 2-Ethylhexyl phthalate (BEHP)
- ◆ Arsenic
- ◆ Low Molecular Weight (LMW) PAHs
- ◆ High Molecular Weight (HMW) PAHs
- ◆ Pesticides
- ◆ Dioxin



1,4-Dioxane
Arsenic
TCE

Initial Risk Drivers Plume Maps

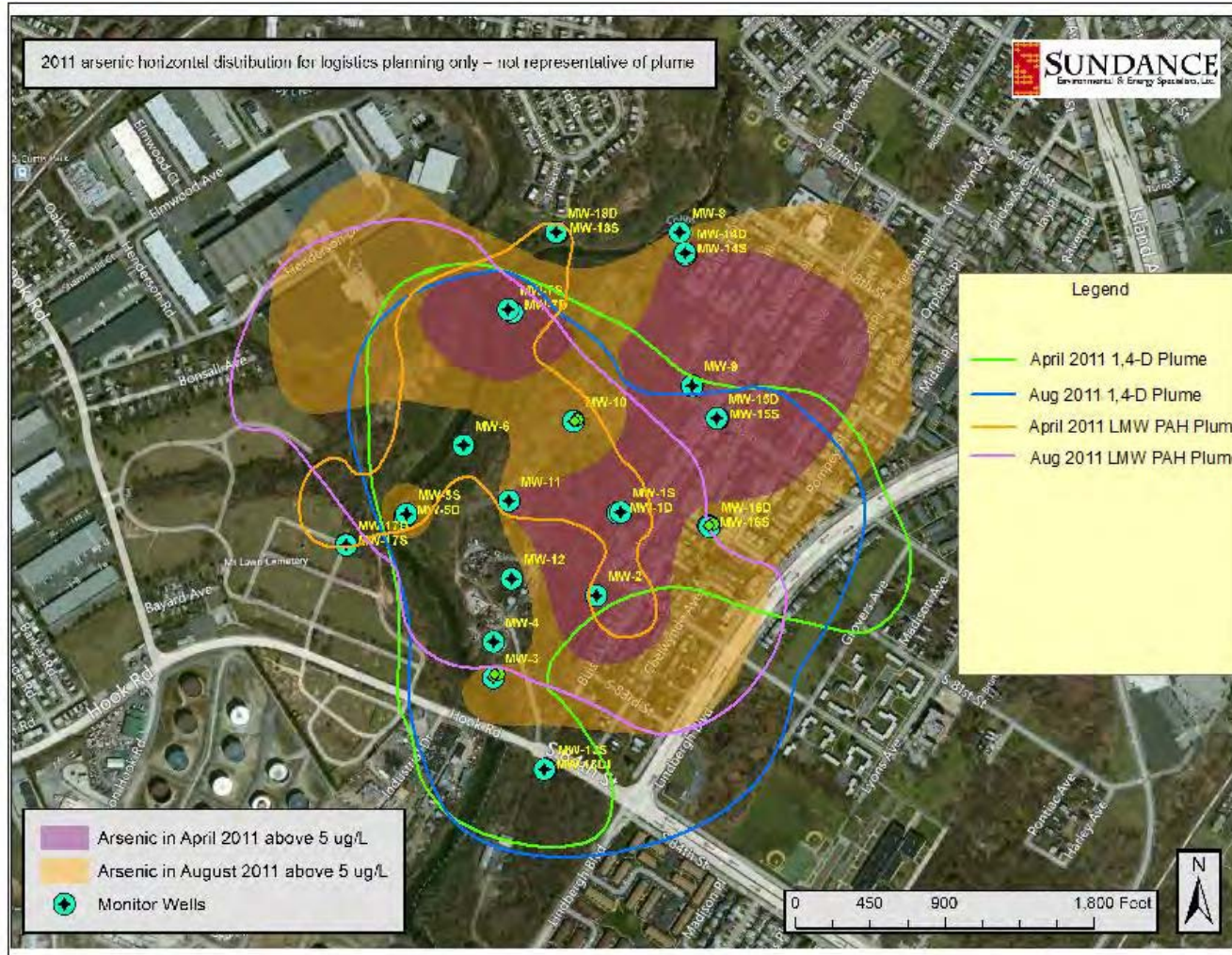

Target Risk Drivers Selected for Field Investigations

◆ 1,4-Dioxane

- Detected in a large number of wells
- Significant human health risk
- Detectable using a mobile lab or MiHPT

◆ Arsenic

- Detected in a large number of wells
- Significant human health and ecologic risk
- Detectable using a mobile lab or simple test kit

◆ Trichloroethene

- Detected in high concentrations near MW-13
- Detectable using a mobile lab or simple test kit
- Focused in single area; not a site wide COC

Approach for Shallow Aquifer Assessment

- ◆ GW sampling from temp. points w/ retractable screen tool (SP-16 or SP-22), slug testing, and soil logging
 - ERT mobile lab for 1,4-D (24 hour TAT); As & TCE sent to Edison, NJ w/ weekly results.
 - April – August 2014; 175 borings; 24 new MWs
- ◆ Periodic update of 3D CSM to guide sample locations
 - EPA OSRTI HQ contract with TT and Sundance
- ◆ Install a series of long-term monitoring points.
- ◆ Perform long-term monitoring/sampling for risk assessment & RI/FS.

***Phytoscreening, direct sensing technologies (e.g., MIP, HPT, EC, and LIF), As & TCE field kits not used based results from DMAs.

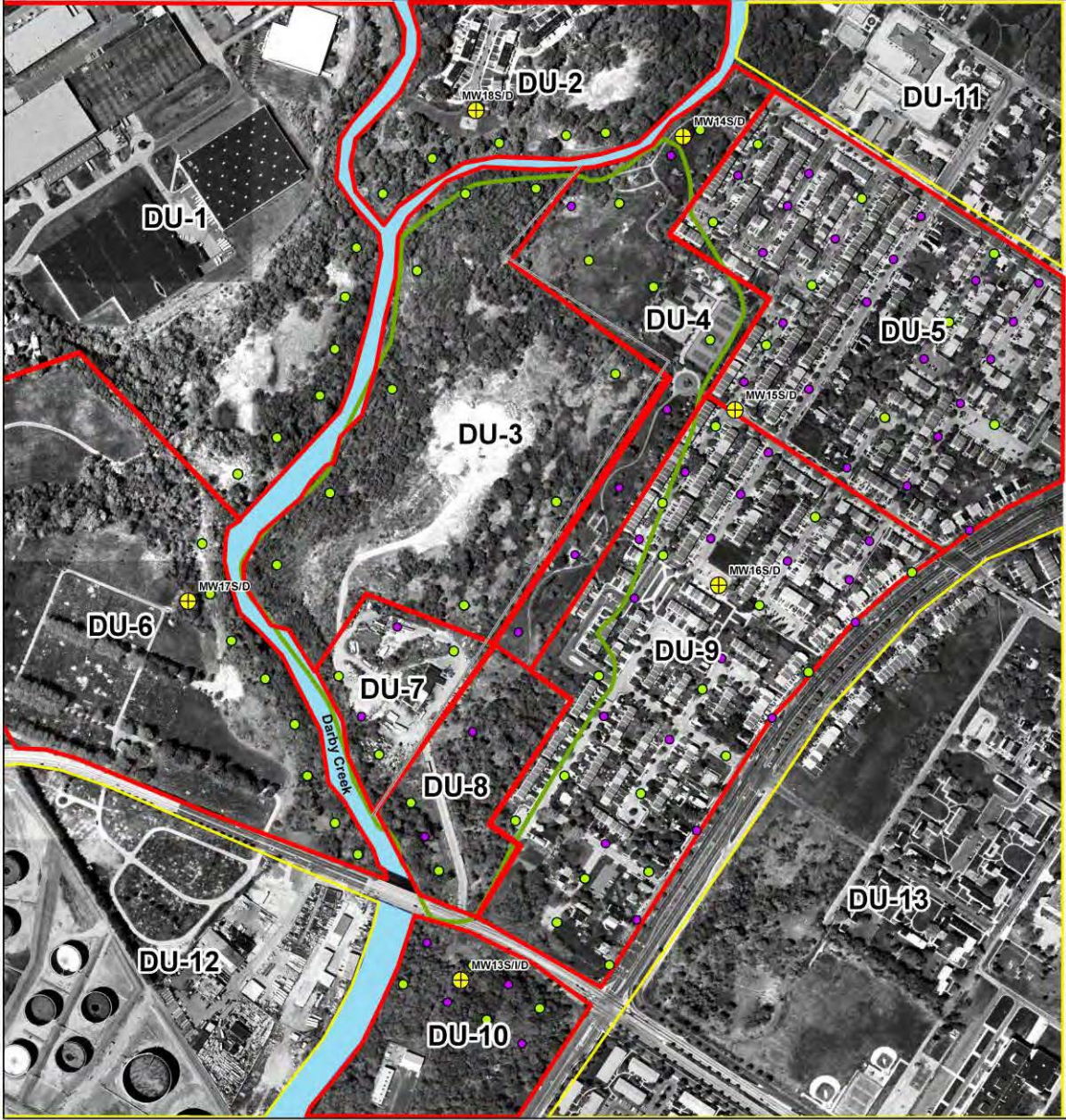

Shallow and Deep Aquifer Decision Units

Figure 2A
 Updated Proposed Decision Units (DUs)
 Lower Darby Creek Area (LDCA) Site
 Clearview Landfill Groundwater (OU-3)
 Philadelphia and Delaware Counties, Pennsylvania

- Preliminary Offset Locations
- Preliminary Starting Locations
- Approximate DU Boundary
- Proposed Expansion Areas
- Historical Extent of Clearview Landfill





300 150 0 300
 Feet
 1:3,600 1 inch = 300 feet



This map is provided by Tetra Tech solely for display and reference purposes and is subject to change without notice. No claims, either real or assumed, as to the absolute accuracy or precision of any data contained herein are made by Tetra Tech, nor will Tetra Tech be held responsible for any use of this document for purposes other than which it was intended.

Tetra Tech, Inc
 Phone: (302) 738-7551
 Toll Free: (800) 462-0910
 www.tetrattech.com

Figure 6
 City Park DU-4, Shallow Aquifer Lower Darby Creek Area (LDCA) Site Clearview Landfill Groundwater (OU-4) Philadelphia and Delaware Counties, Pennsylvania

Shallow Aquifer Screening for Arsenic

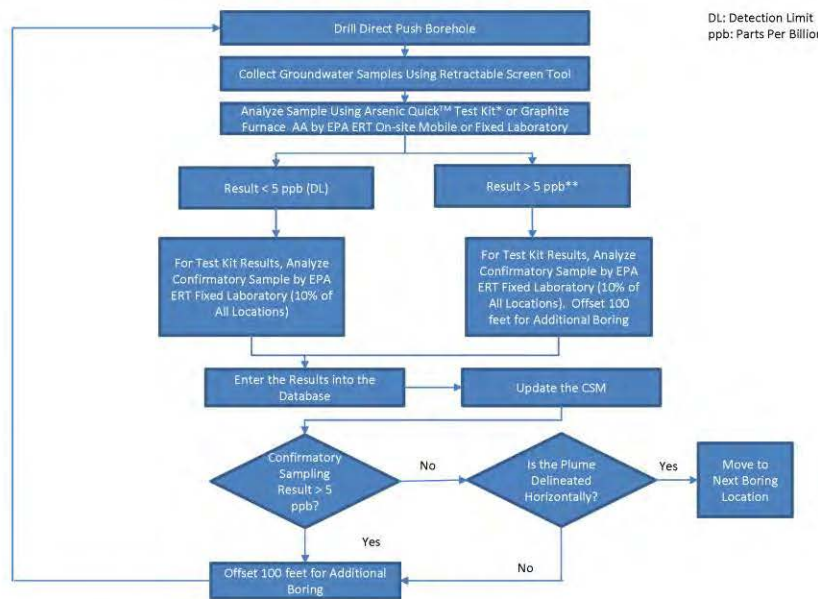

DL: Detection Limit
 ppb: Parts Per Billion

* Approved by EPA Environmental Technology Verification Program.
 ** EPA Region 3 BTAG Freshwater Screening Benchmark (7/2006)

Shallow Aquifer Screening for 1,4-Dioxane

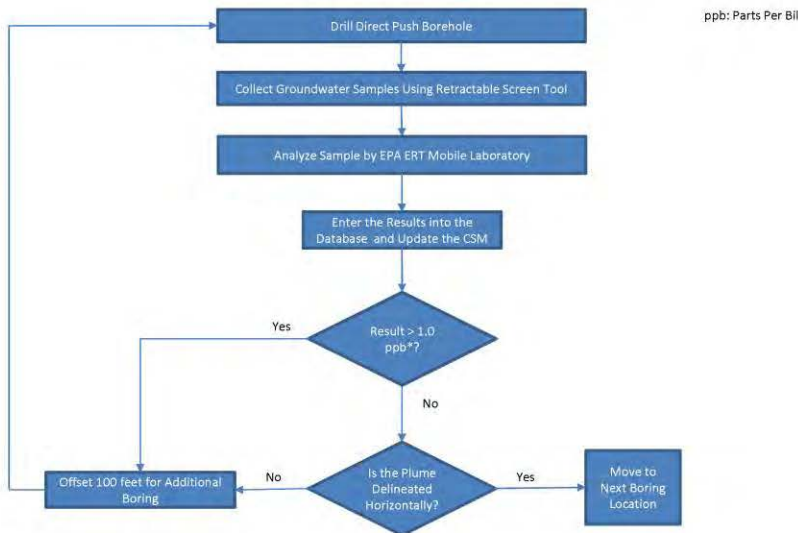

ppb: Parts Per Billion

* Detection Limit of an Analytical Method

4DIM Projected 1,4-Dioxane Plume Map (Shallow Aquifer)

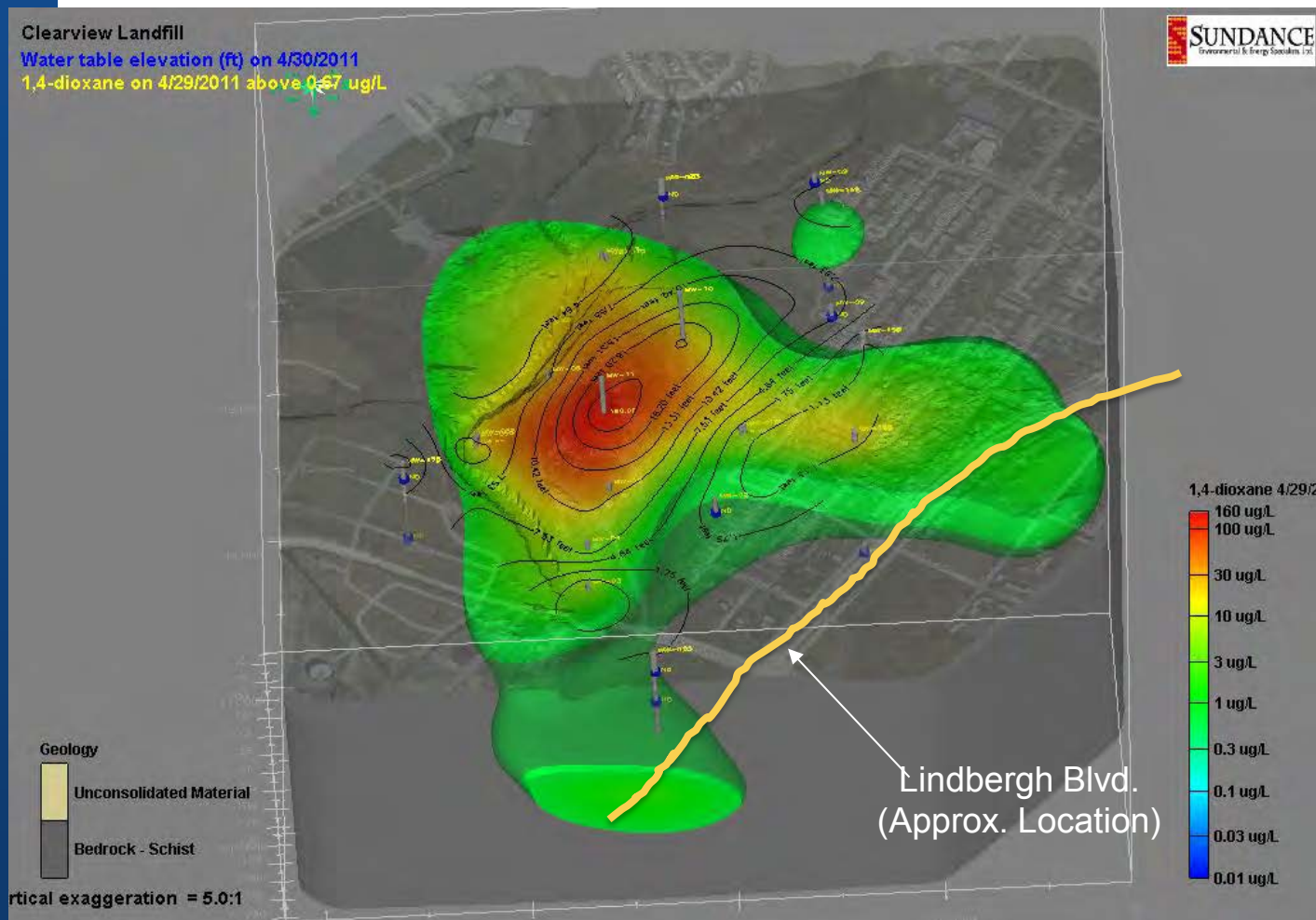

Estimated 1,4-dioxane plume exceeding EPA RSL of 0.67 ppb

Developed prior to field investigation for OU3 using April 2011 sample results

Actual 4DIM & Plan View 1,4-Dioxane Plume Map (Shallow Aquifer)

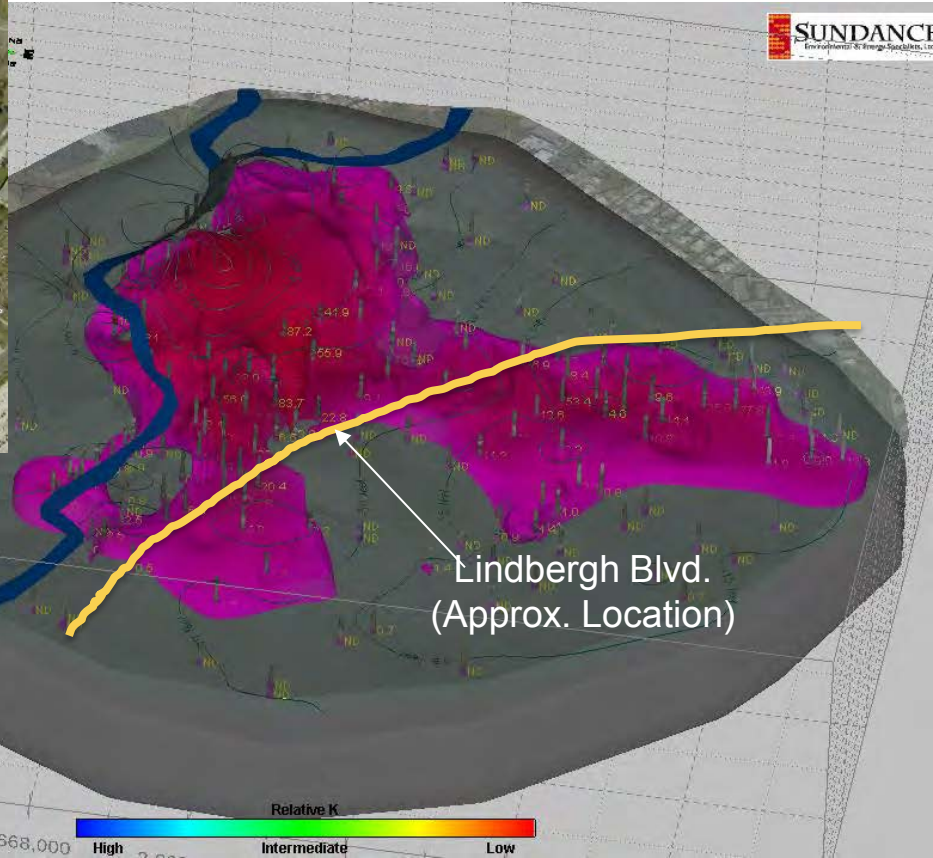
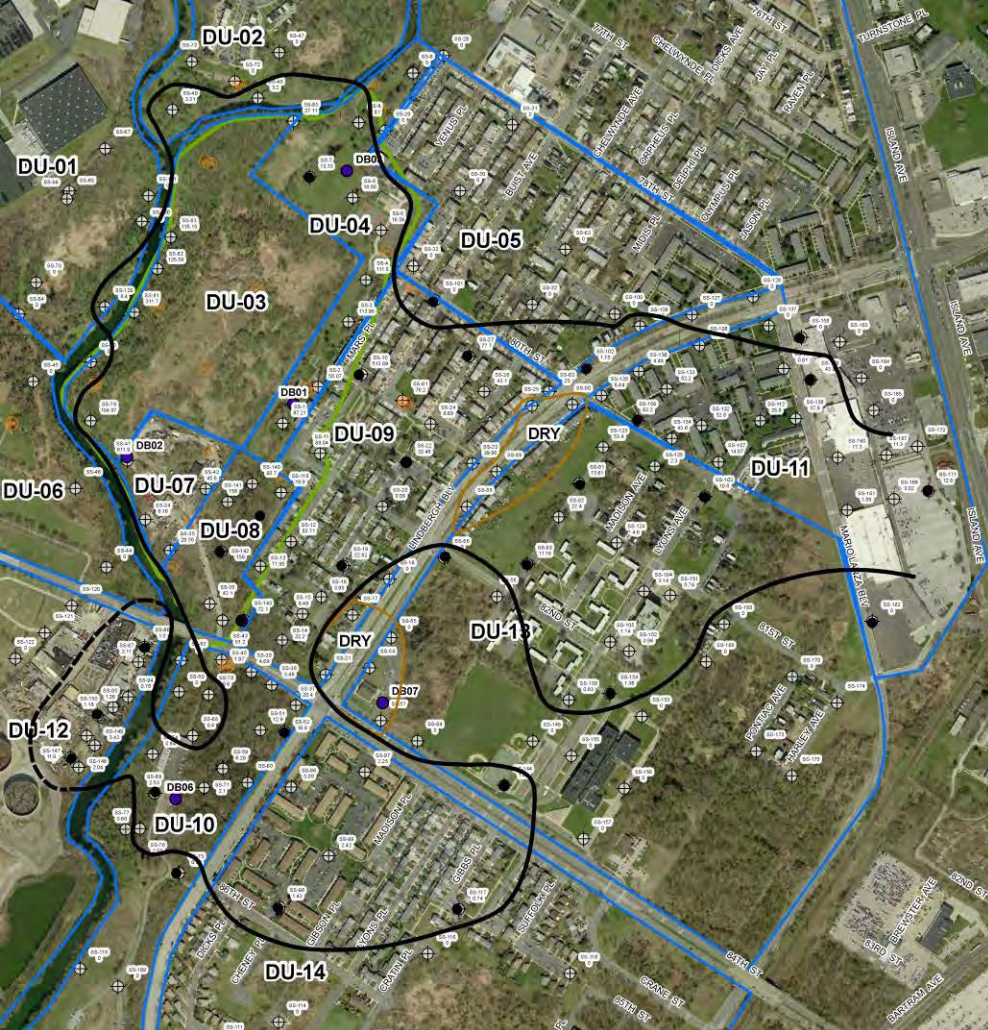

SUNDANCE
Environmental & Energy Solutions, Inc.

Plume boundary based on 1 ppb contour



Vertical exaggeration = 10:1

Relative K

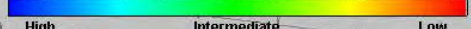

Approach for Deep Aquifer Assessment

- ◆ Establish the lateral and vertical extent of the deep groundwater plume
 - Concern about highly weathered bedrock along paleo channels below LF
- ◆ Borehole drilling using a sonic drilling in overburden/waste; air core barrel in bedrock → competent samples for lithology
 - July – October 2014; 7 deep borings; 4 new MWs
- ◆ Targeted maximum depths of 300' bgs
- ◆ Conduct sampling at each water-bearing zone encountered within the borehole using mobile laboratory
- ◆ Geophysical logging to identify the fracture zones and to determine screened intervals of the wells
- ◆ Select well locations (up to 6 pairs of wells, including one background location).

Deep Aquifer Boring Locations & Decision Tree

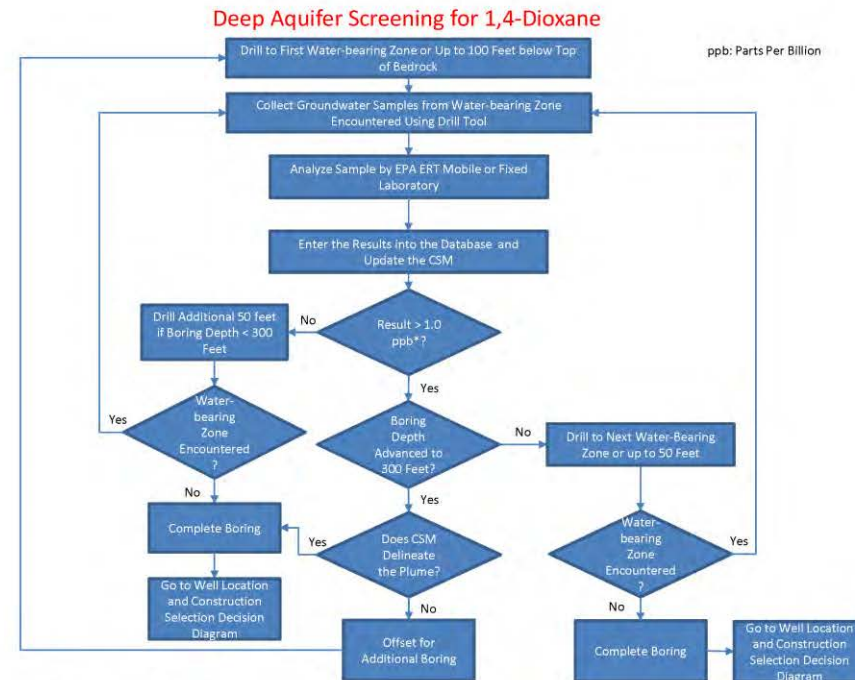
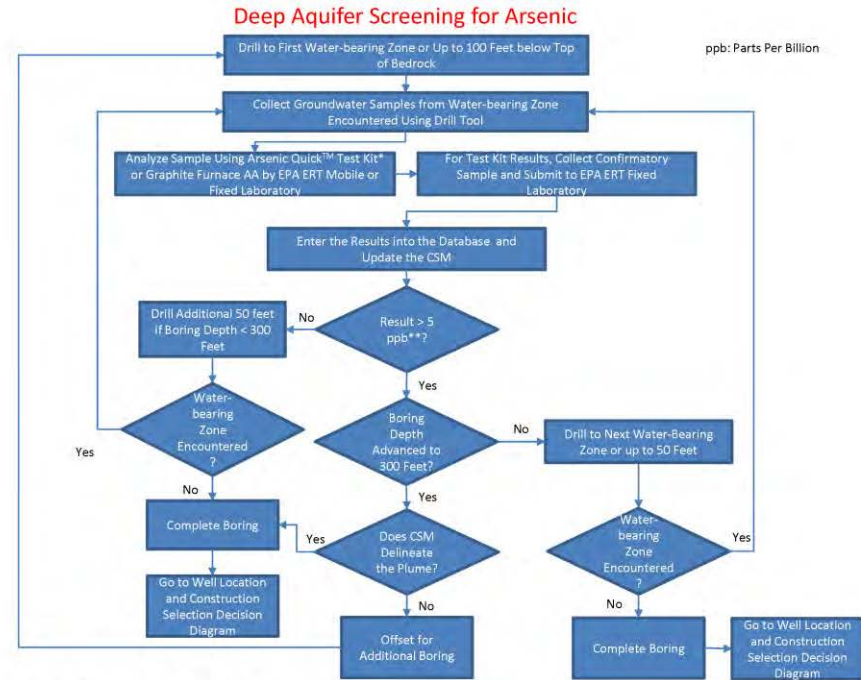
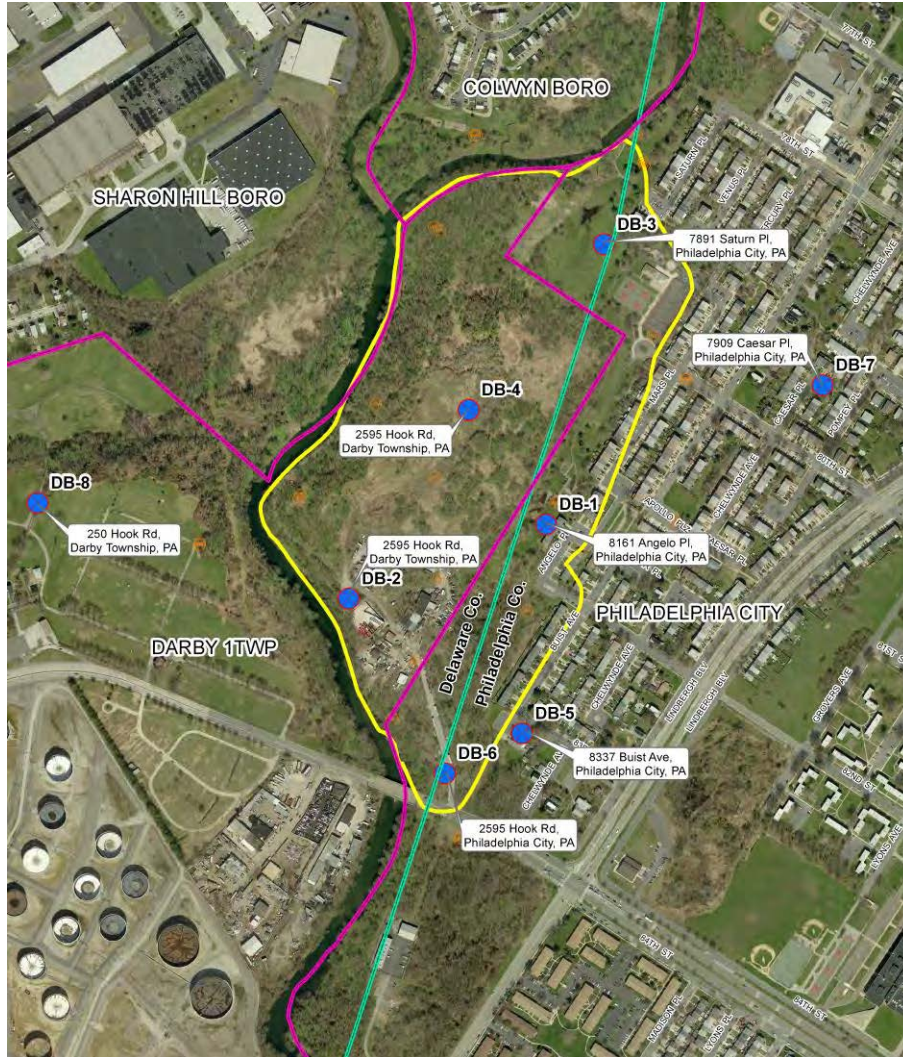

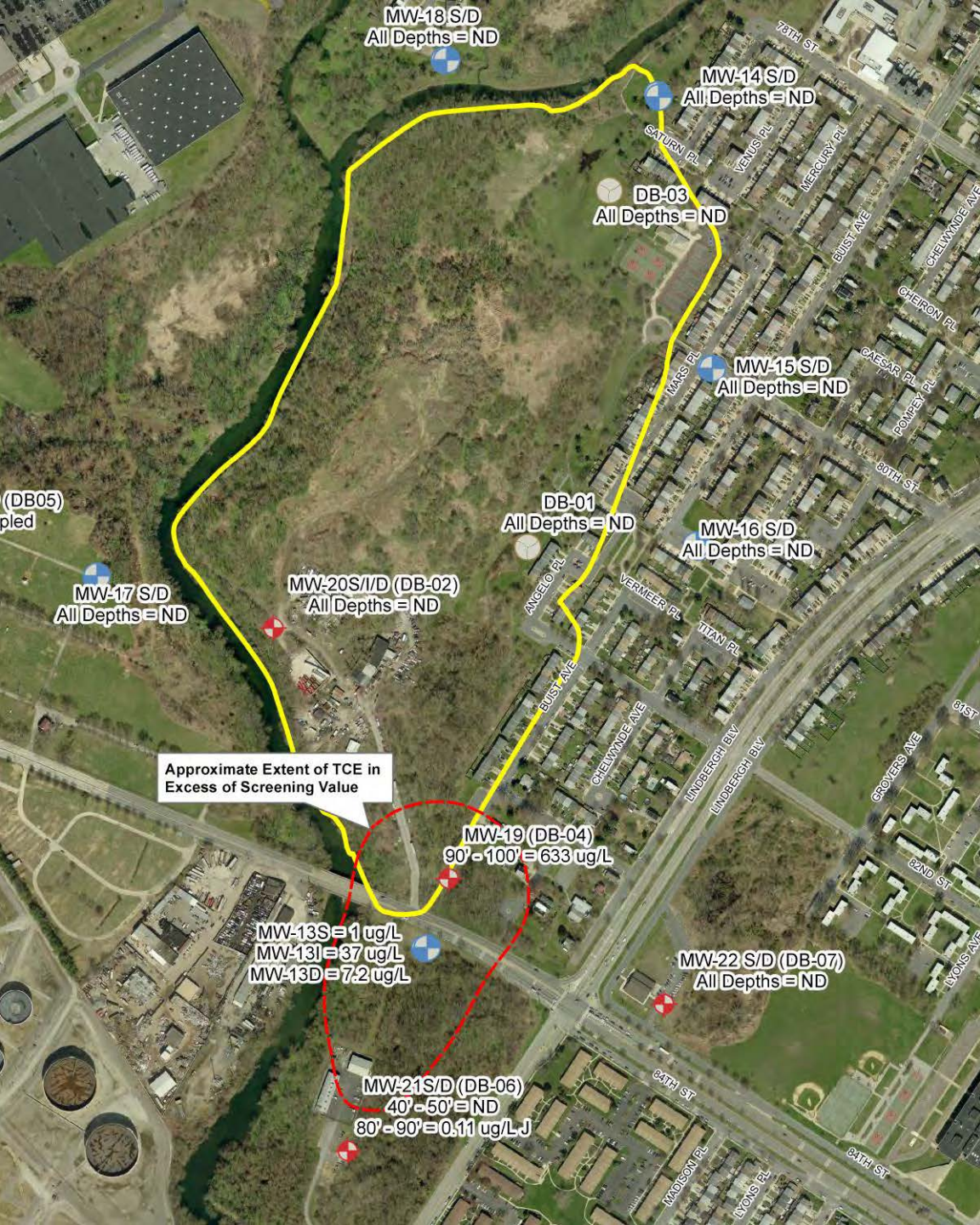

TCE Deep Aquifer Plume (approximate boundary)

Shallow Arsenic Plume

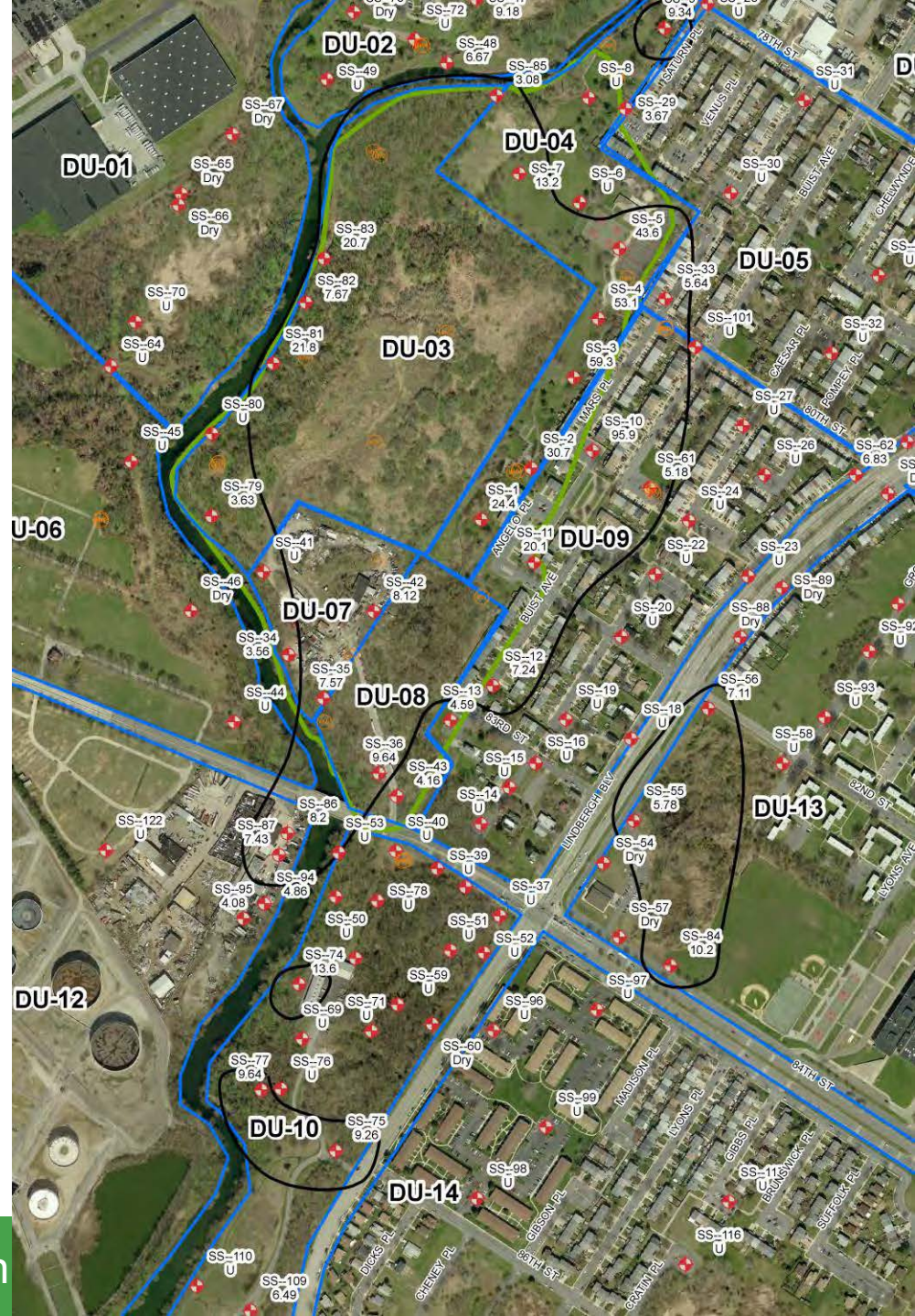
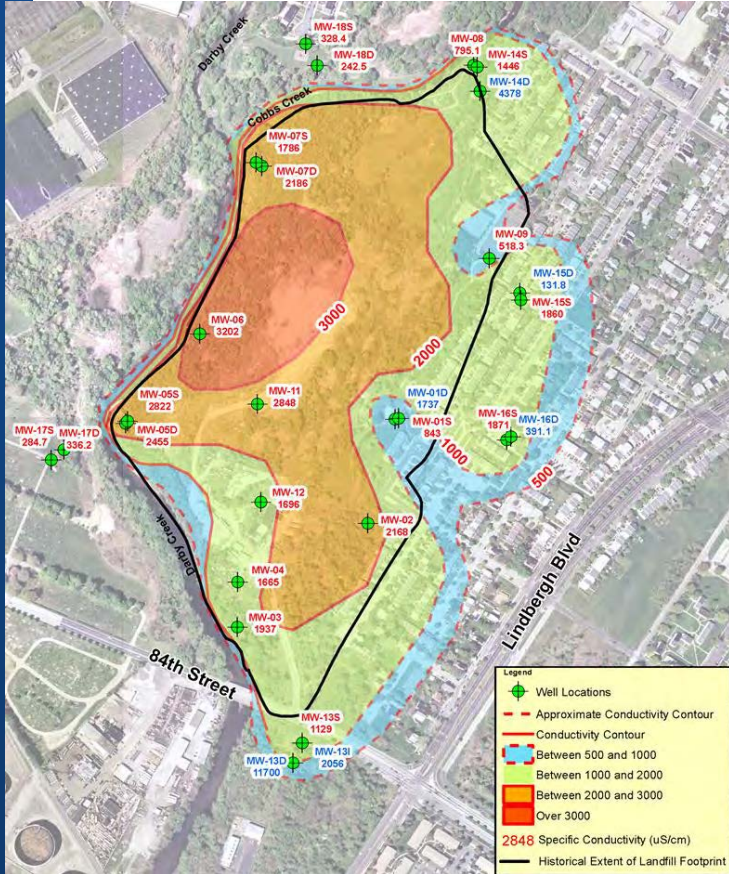

Approach for Pore Water Assessment

- ◆ Phytoscreening for 1,4-D and VOCs
 - Abandoned after DMA
- ◆ Real-time sensing tools (thermal imaging camera, specific conductivity meters) to target for water and sediment sampling
- ◆ Porewater sampling of stream bank at low-tide
- ◆ Multi-level porewater sampling from stream bottom
- ◆ Surficial geophysics to determine presence/orientation of fractures under stream channel



Development of the U.S.S Walker

- ◆ The hull was derived from a recycled RiverCat ADP catamaran.
- ◆ Modifications were made to the hull to accept an electric airplane motor for propulsion.
- ◆ Steered was achieved by articulating the motor with a radio controlled servo.
- ◆ The boat and electronics were powered with lithium-polymer batteries (11 V).



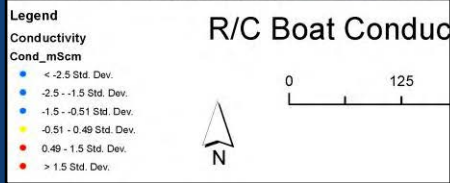
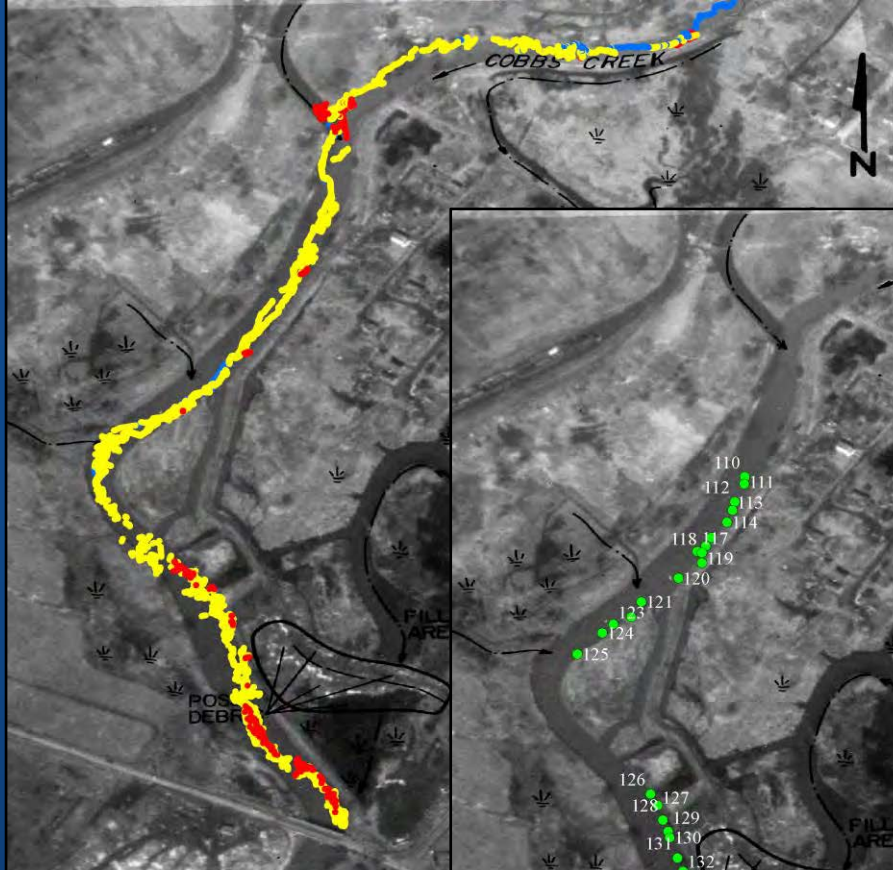

R/C Boat Conductivity

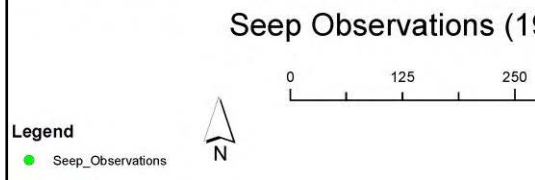
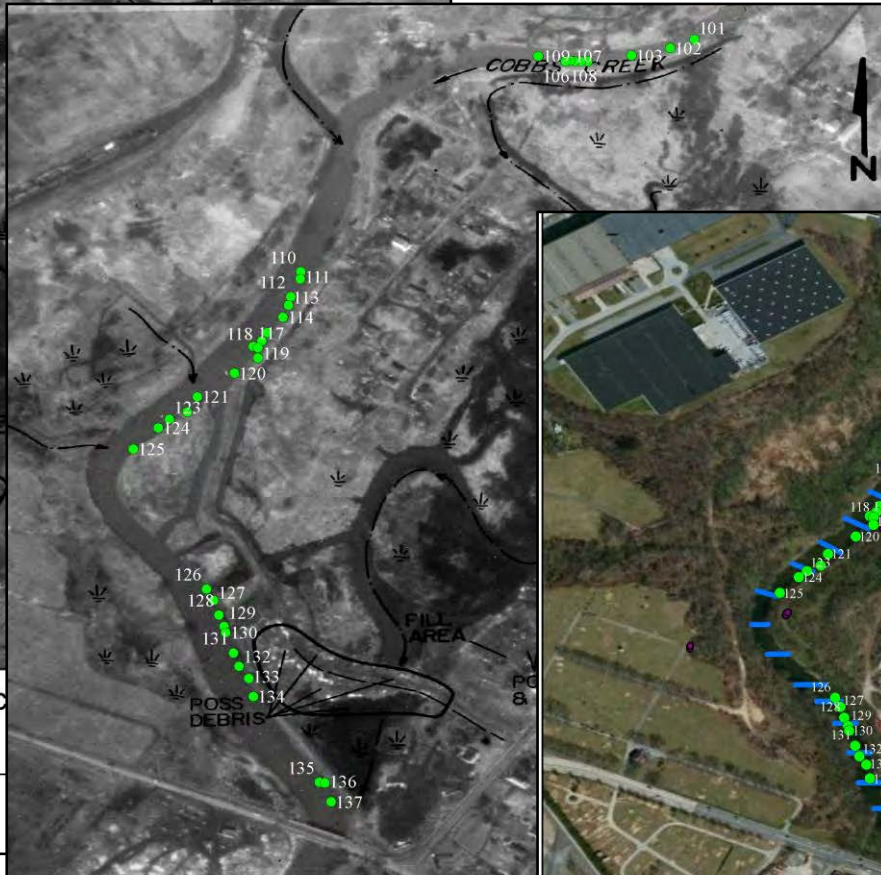

Seep Observations (1)

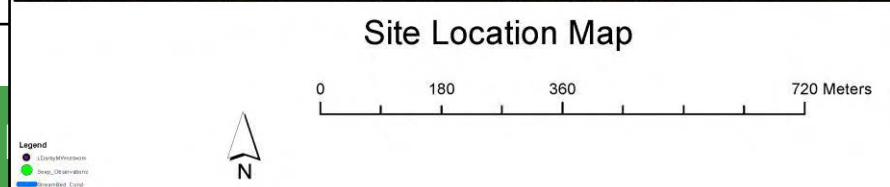
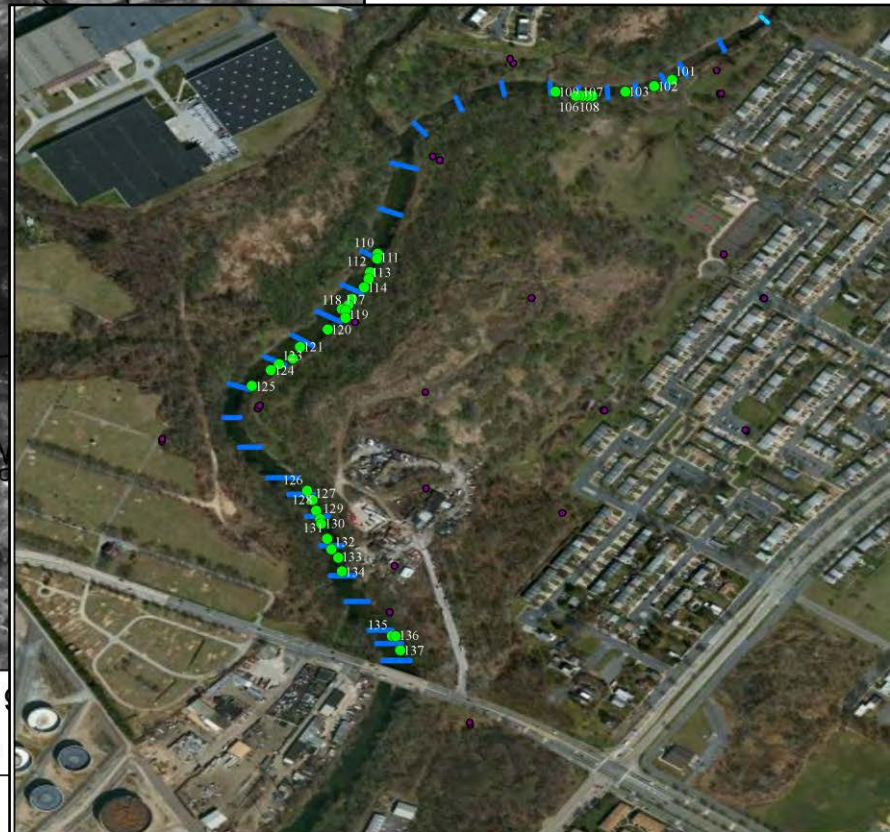

Site Location Map

USGS Porewater Sampling Locations



Fabricated depth-specific porewater sampling Device

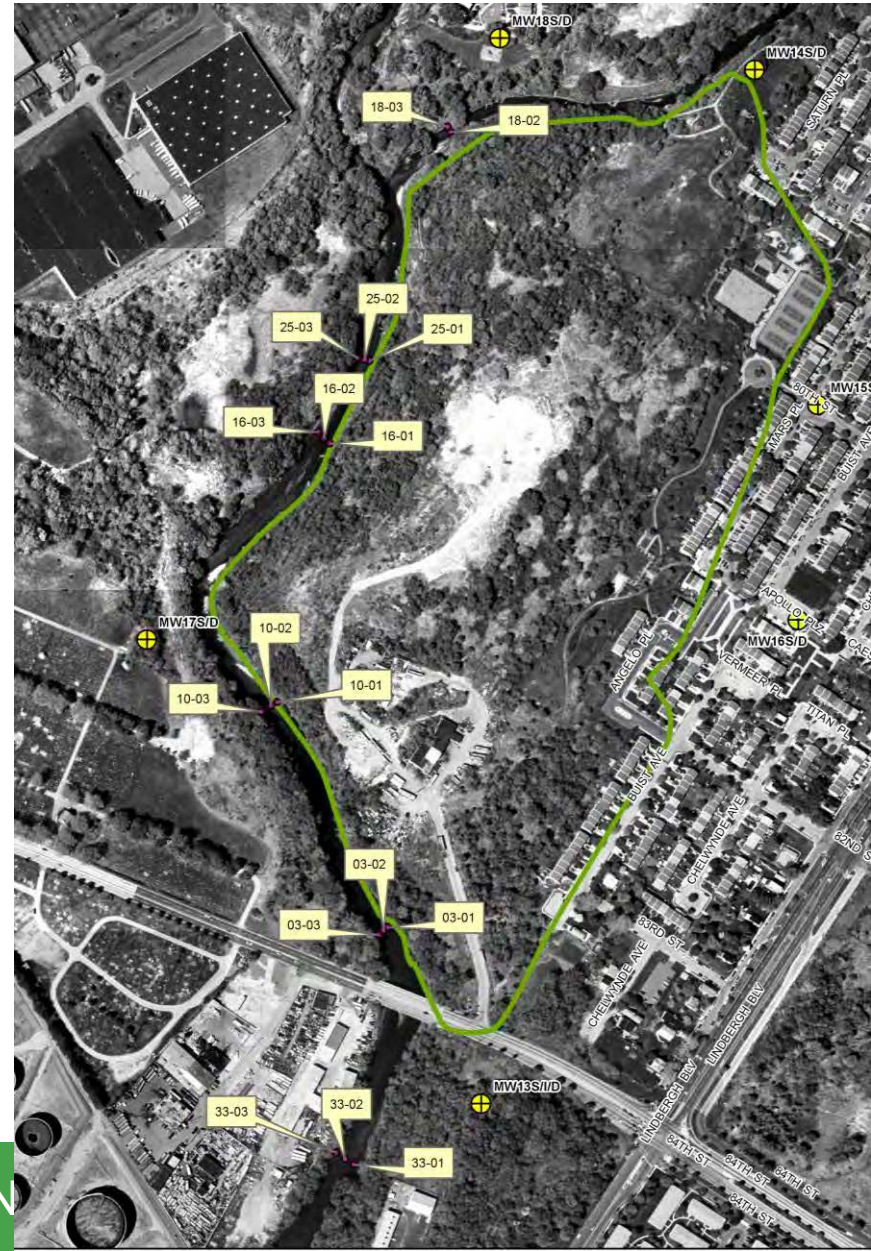

Dynamic Investigation Lessons

- ◆ Must be flexible in changing plans
- ◆ Demonstrations of Method Applicability are essential
- ◆ All field crew must understand the project goals and decision logic
- ◆ Negotiate as much access as you can before you start
- ◆ Talk with technical team and analytical nerds before finalizing plans
 - Potential for HQ, ERT, ORD, etc. resources
- ◆ Allocate contingency resources (more than you normally would)